

## 1 MHz Bandwidth, Galvanically Isolated Current Sensor IC in Small Footprint SOIC8 Package

### FEATURES AND BENEFITS

- Industry-leading noise performance with greatly improved bandwidth through proprietary amplifier and filter design techniques
- High bandwidth 1 MHz analog output
- Patented integrated digital temperature compensation circuitry allows high accuracy over temperature in an open loop sensor
- 1.2 mΩ primary conductor resistance for low power loss and high inrush current withstanding capability
- Small footprint, low-profile SOIC8 package suitable for space-constrained applications
- Integrated shield virtually eliminates capacitive coupling from current conductor to die due to high dV/dt voltage transients
- 5 V, single supply operation
- Output voltage proportional to AC or DC current
- Factory-trimmed sensitivity and quiescent output voltage for improved accuracy
- High PSRR for noisy environments



CB Certificate Number:  
US-32848-UL

### PACKAGE: 8-Pin SOIC (suffix LC)

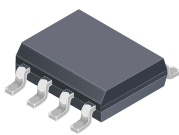

Not to scale

### DESCRIPTION

The Allegro™ ACS730 provides economical and precise solutions for AC or DC current sensing in industrial, commercial, and communications systems. The device package allows for easy implementation by the customer. Typical applications include motor control, load detection and management, switched-mode power supplies, and overcurrent fault protection.

The device consists of a precise, low-offset, linear Hall sensor circuit with a copper conduction path located near the surface of the die. Applied current flowing through this copper conduction path generates a magnetic field which is sensed by the integrated Hall IC and converted into a proportional voltage. Device accuracy is optimized through the close proximity of the magnetic field to the Hall transducer. A precise, proportional voltage is provided by the Hall IC, which is programmed for accuracy after packaging. The output of the device has a positive slope when an increasing current flows through the primary copper conduction path (from pins 1 and 2, to pins 3 and 4), which is the path used for current sensing. The internal resistance of this conductive path is typically 1.2 mΩ, providing low power loss.

The terminals of the conductive path are electrically isolated from the sensor leads (pins 5 through 8). This allows the ACS730 current sensor to be used in high-side current sense applications without the use of high-side differential amplifiers or other costly isolation techniques.

The ACS730 is provided in a small, low-profile surface-mount SOIC8 package. The leadframe is plated with 100% matte tin, which is compatible with standard lead (Pb) free printed circuit board assembly processes. Internally, the flip-chip device is considered Pb-free. However, the solder bump connections are available in a Pb-free or high-temperature Pb-based option. Part numbers followed by “-S” are manufactured with tin-silver-based solder bumps, making these parts Pb-free compliant without the use of RoHS exemptions. Part numbers followed by “-T” are manufactured with Pb-based solder bumps using allowed RoHS exemptions.

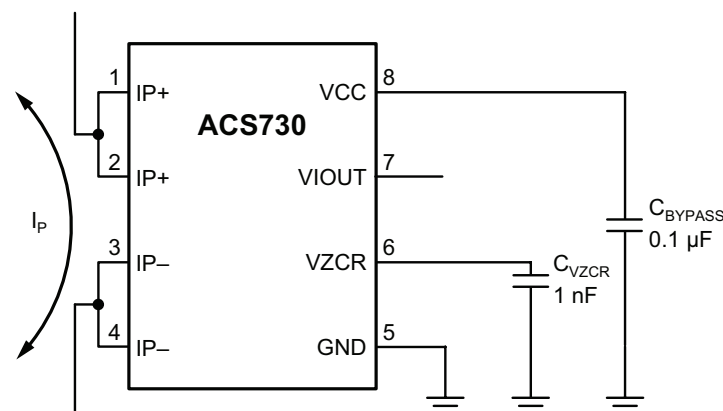

The ACS730 outputs an analog signal,  $V_{IOUT}$ , that varies linearly with the bidirectional AC or DC primary sensed current,  $I_P$ , within the range specified.

### Typical Application

# ACS730

## 1 MHz Bandwidth, Galvanically Isolated Current Sensor IC in Small Footprint SOIC8 Package

### SELECTION GUIDE

Part Number [1]	Optimized Range, $I_P$ (A)	Sensitivity [1], Sens(Typ) (mV/A)	$T_A$ (°C)	Packing
<b>-S VARIANT [2]</b>				
ACS730KLCTR-20AB-S	±20	100	-40 to 125	Tape and reel, 3000 pieces per reel
ACS730KLCTR-30AB-S	±30	66		
ACS730KLCTR-30AU-S	30	120		
ACS730KLCTR-40AB-S	±40	50		
ACS730KLCTR-50AB-S	±50	40		
ACS730KLCTR-65AB-S	±65	30		
ACS730KLCTR-80AU-S	80	50		
<b>-T VARIANT [3]</b>				
ACS730KLCTR-20AB-T	±20	100	-40 to 125	Tape and reel, 3000 pieces per reel
ACS730KLCTR-30AB-T	±30	66		
ACS730KLCTR-30AU-T	30	120		
ACS730KLCTR-40AB-T	±40	50		
ACS730KLCTR-50AB-T	±50	40		
ACS730KLCTR-65AB-T	±65	30		
ACS730KLCTR-80AU-T	80	50		

[1] Measured at  $V_{CC} = 5$  V.

[2] "-S" denotes lead-free construction with tin-silver-based solder bumps.

[3] "-T" denotes Pb-contained construction with Pb-based solder bumps. Operating performance of "-T" and "-S" devices are identical. "-T" devices are RoHS compliant using allowed exemptions provided in Annex III and IV of Directive 2011/65/EU [Exemptions 7(a), 15, 15(a), as applicable].

### ABSOLUTE MAXIMUM RATINGS

Characteristic	Symbol	Notes	Rating	Units
Supply Voltage	$V_{CC}$		6	V
Reverse Supply Voltage	$V_{CC(R)}$		-0.1	V
Output Voltage	$V_{IOUT}$		6	V
Reverse Output Voltage	$V_{IOUT(R)}$		-0.1	V
Zero Current Reference Voltage	$V_{ZCR}$		20	V
Reverse Zero Current Reference Voltage	$V_{ZCR(R)}$		-0.1	V
Operating Ambient Temperature	$T_A$	Range K	-40 to 125	°C
Junction Temperature	$T_J(\text{max})$		165	°C
Storage Temperature	$T_{stg}$		-65 to 170	°C

### ISOLATION CHARACTERISTICS

Characteristic	Symbol	Notes	Value	Units
Dielectric Strength Test Voltage [1]	$V_{ISO}$	Agency type-tested for 60 seconds per UL standard 60950-1 (edition 2); production-tested at VISO for 1 second, in accordance with UL 60950-1 (edition 2).	2400	$V_{RMS}$
		Agency type-tested for 60 seconds per UL 1577 (edition 5); production-tested at 2520 VRMS for 1 second, in accordance with UL 1577 (edition 5).	2100	$V_{RMS}$
Working Voltage for Basic Isolation [1]	$V_{WVBI}$	Maximum approved working voltage for basic (single) isolation according to UL 60950-1 (edition 2).	420	$V_{PK}$ or VDC
			297	$V_{RMS}$
Clearance	$D_{cl}$	Minimum distance through air from IP leads to signal leads	3.9	mm
Creepage	$D_{cr}$	Minimum distance along package body from IP leads to signal leads	3.9	mm
Comparative Tracking Index	CTI	Material Group II	400 to 599	V

[1] Certification pending for lead-free variants.

### THERMAL CHARACTERISTICS

Characteristic	Symbol	Test Conditions	Value	Units
Package Thermal Resistance (Junction to Ambient)	$R_{\theta JA}$	Mounted on the Allegro evaluation board with 1500 mm <sup>2</sup> of 4 oz. copper on each side, connected to pins 1 and 2, and to pins 3 and 4, with thermal vias connecting the layers. Performance values include the power consumed by the PCB. [1]	23	°C/W
Package Thermal Resistance (Junction to Lead)	$R_{\theta JL}$	Mounted on the Allegro ASEQ730 evaluation board.	5	°C/W

[1] Further information about board design and thermal performance also can be found in the Applications Information section of this datasheet.

### Functional Block Diagram

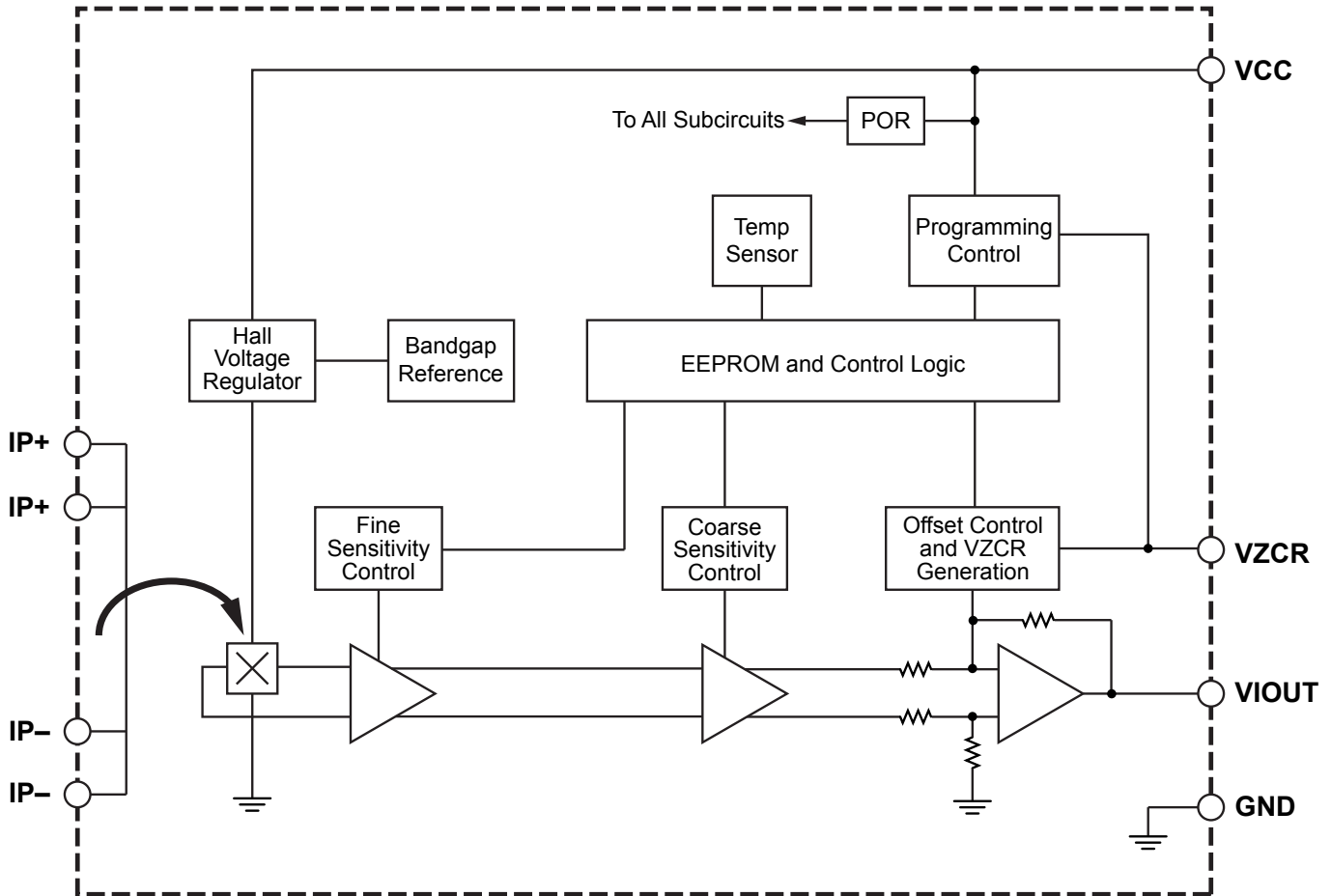

### Pinout Diagram and Terminal List Table

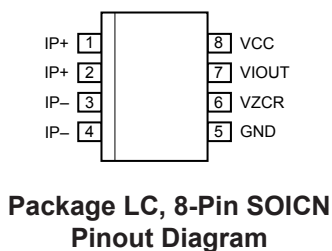

**Terminal List Table**

Number	Name	Description
1, 2	IP+	Terminals for current being sensed; fused internally
3, 4	IP-	Terminals for current being sensed; fused internally
5	GND	Signal ground terminal
6	VZCR	Zero current reference; outputs a DC voltage equal to $V_{IOUT}$ at $I_P = 0$ A
7	VIOUT	Analog output signal
8	VCC	Device power supply terminal

### COMMON ELECTRICAL CHARACTERISTICS [1]: Valid over full range of $T_A$ , $V_{CC} = 5\text{ V}$ , unless otherwise specified

Characteristic	Symbol	Test Conditions	Min.	Typ.	Max.	Unit
Supply Voltage	$V_{CC}$		4.5	5	5.5	V
Supply Current	$I_{CC}$	$V_{CC} = 5\text{ V}$ , output open	–	17	25	mA
Power-On Time	$t_{PO}$	$T_A = 25^\circ\text{C}$	–	150	–	$\mu\text{s}$
Output Capacitance Load	$C_L$	VIOUT to GND	–	–	0.47	nF
Reference Capacitance Load	$C_{VZCR}$	VZCR to GND	–	–	1	nF
Output Resistive Load	$R_L$	VIOUT to GND, VIOUT to VCC	10	–	–	k $\Omega$
Reference Resistive Load	$R_{VZCR}$	VZCR to GND, VZCR to VCC	10	–	–	k $\Omega$
Output High Saturation Voltage [2]	$V_{OH}$	VIOUT, $T_A = 25^\circ\text{C}$	$V_{CC} - 0.4$	$V_{CC} - 0.3$	–	V
Output Low Saturation Voltage [2]	$V_{OL}$	VIOUT, $T_A = 25^\circ\text{C}$	–	0.1	0.2	V
Primary Conductor Resistance	$R_{IP}$	$T_A = 25^\circ\text{C}$	–	1.2	–	m $\Omega$
Primary Conductor Inductance	$L_{IP}$	$T_A = 25^\circ\text{C}$	–	2	–	nH
Magnetic Coupling Factor	MCF	$T_A = 25^\circ\text{C}$	–	10	–	G/A
Rise Time	$t_r$	$T_A = 25^\circ\text{C}$ , $C_L = 0.47\text{ nF}$	–	0.6	–	$\mu\text{s}$
Propagation Delay	$t_{pd}$	$T_A = 25^\circ\text{C}$ , $C_L = 0.47\text{ nF}$	–	0.2	–	$\mu\text{s}$
Response Time	$t_{RESPONSE}$	$T_A = 25^\circ\text{C}$ , $C_L = 0.47\text{ nF}$	–	0.7	–	$\mu\text{s}$
Output Slew Rate	SR	$T_A = 25^\circ\text{C}$ , $C_L = 1\text{ nF}$	–	2.67	–	V/ $\mu\text{s}$
Internal Bandwidth	BW	Small signal $-3\text{ dB}$ ; $C_L = 0.47\text{ nF}$	–	1	–	MHz
Noise Density	$I_{ND}$	Input-referenced noise density; $T_A = 25^\circ\text{C}$ , $C_L = 0.47\text{ nF}$	–	40	–	$\mu\text{A}/\sqrt{(\text{Hz})}$
Noise	$I_N$	Input-referenced noise; $T_A = 25^\circ\text{C}$ , $C_L = 0.47\text{ nF}$	–	40	–	mA <sub>RMS</sub>
Power Supply Rejection Ratio	PSRR	0 to 200 Hz, 100 mV pk-pk ripple on $V_{CC}$ , $I_P = 0\text{ A}$ , VIOUT and VZCR	–	35	–	dB
Sensitivity Power Supply Rejection Ratio	SPSRR	DC, $V_{CC}(\text{min}) < V_{CC} < V_{CC}(\text{max})$ , $I_P = I_{PR}(\text{max})$	–	15	–	dB
Offset Power Supply Rejection Ratio	OPSRR	DC, $V_{CC}(\text{min}) < V_{CC} < V_{CC}(\text{max})$	–	30	–	dB
Output Source Current	$I_{OUT(\text{src})}$	VIOUT shorted to GND	–	5.5	–	mA
Output Sink Current	$I_{OUT(\text{snk})}$	VIOUT shorted to VCC	–	3	–	mA
Zero Current Reference Offset Voltage	$V_{ZCR(\text{ofs})}$	$T_A = 25^\circ\text{C}$	–10	$\pm 3$	10	mV
		$T_A = 25^\circ\text{C}$ to $125^\circ\text{C}$	–20	$\pm 10$	20	mV
		$T_A = -40^\circ\text{C}$ to $25^\circ\text{C}$	–	$\pm 10$	–	mV
Reference Source Current	$I_{VZCR(\text{src})}$	VZCR shorted to GND	–	2	–	mA
Reference Sink Current	$I_{VZCR(\text{snk})}$	VZCR shorted to VCC	–	14	–	mA

[1] Device may be operated at higher primary current levels,  $I_P$ , ambient temperatures,  $T_A$ , and internal leadframe temperatures, provided the Maximum Junction Temperature,  $T_J(\text{max})$ , is not exceeded.

[2] The sensor IC will continue to respond to current beyond the range of  $I_P$  until the high or low saturation voltage; however, the nonlinearity in this region will be worse than through the rest of the measurement range.

**xKLCTR-20AB PERFORMANCE CHARACTERISTICS:** Valid over full range of  $T_A$ ,  $V_{CC} = 5\text{ V}$ ,  $C_{BYPASS} = 0.1\ \mu\text{F}$ , unless otherwise specified

Characteristic	Symbol	Test Conditions	Min.	Typ. [1]	Max.	Unit
<b>NOMINAL PERFORMANCE</b>						
Current Sensing Range	$I_{PR}$		-20	-	20	A
Sensitivity	Sens		-	100	-	mV/A
Zero Current Output Voltage	$V_{IOUT(Q)}$	$I_P = 0\text{ A}$ , $T_A = 25^\circ\text{C}$	-	2.5	-	V
Zero Current Reference Voltage	$V_{ZCR}$	$T_A = 25^\circ\text{C}$	-	2.5	-	V
<b>ACCURACY PERFORMANCE</b>						
Total Output Error [2]	$E_{TOT}$	$I_P = I_{P(MAX)}$ ; $T_A = 25^\circ\text{C}$ to $125^\circ\text{C}$	-4	$\pm 3$	4	%
		$I_P = I_{P(MAX)}$ ; $T_A = -40^\circ\text{C}$ to $25^\circ\text{C}$	-	$\pm 4$	-	%
Sensitivity Error	$E_{sens}$	$I_P = I_{P(MAX)}$ ; $T_A = 25^\circ\text{C}$ to $125^\circ\text{C}$	-2.5	$\pm 1.5$	2.5	%
		$I_P = I_{P(MAX)}$ ; $T_A = -40^\circ\text{C}$ to $25^\circ\text{C}$	-	$\pm 4$	-	%
Offset Voltage	$V_{OE}$	$I_P = 0\text{ A}$ ; $T_A = 25^\circ\text{C}$ to $125^\circ\text{C}$	-75	$\pm 50$	75	mV
		$I_P = 0\text{ A}$ ; $T_A = -40^\circ\text{C}$ to $25^\circ\text{C}$	-	$\pm 50$	-	mV
Nonlinearity	$E_{LIN}$	Through the full range of $I_P$ ; $T_A = 25^\circ\text{C}$ to $125^\circ\text{C}$	-2	$\pm 0.75$	2	%
		Through the full range of $I_P$ ; $T_A = -40^\circ\text{C}$ to $25^\circ\text{C}$	-	$\pm 0.75$	-	%
<b>LIFETIME DRIFT CHARACTERISTICS</b>						
Total Output Error Including Lifetime Drift	$E_{tot\_drift}$	$I_P = 20\text{ A}$	-	$\pm 6.7$	-	%
Sensitivity Error Including Lifetime Drift	$E_{sens\_drift}$	$I_P = 20\text{ A}$	-	$\pm 3.8$	-	%
Offset Voltage Including Lifetime Drift	$V_{off\_drift}$	$I_P = 0\text{ A}$	-	$\pm 118$	-	mV

[1] Typical values with  $\pm$  are 3 sigma values.

[2] Percentage of  $I_P$ .

**xKLCTR-30AB PERFORMANCE CHARACTERISTICS:** Valid over full range of  $T_A$ ,  $V_{CC} = 5\text{ V}$ ,  $C_{BYPASS} = 0.1\ \mu\text{F}$ , unless otherwise specified

Characteristic	Symbol	Test Conditions	Min.	Typ. [1]	Max.	Unit
<b>NOMINAL PERFORMANCE</b>						
Current Sensing Range	$I_{PR}$		-30	-	30	A
Sensitivity	Sens		-	66	-	mV/A
Zero Current Output Voltage	$V_{IOUT(Q)}$	$I_P = 0\text{ A}$ , $T_A = 25^\circ\text{C}$	-	2.5	-	V
Zero Current Reference Voltage	$V_{ZCR}$	$T_A = 25^\circ\text{C}$	-	2.5	-	V
<b>ACCURACY PERFORMANCE</b>						
Total Output Error [2]	$E_{TOT}$	$I_P = I_{P(MAX)}$ ; $T_A = 25^\circ\text{C}$ to $125^\circ\text{C}$	-5	$\pm 3$	5	%
		$I_P = I_{P(MAX)}$ ; $T_A = -40^\circ\text{C}$ to $25^\circ\text{C}$	-	$\pm 5$	-	%
Sensitivity Error	$E_{sens}$	$I_P = I_{P(MAX)}$ ; $T_A = 25^\circ\text{C}$ to $125^\circ\text{C}$	-3.5	$\pm 2.5$	3.5	%
		$I_P = I_{P(MAX)}$ ; $T_A = -40^\circ\text{C}$ to $25^\circ\text{C}$	-	$\pm 5$	-	%
Offset Voltage	$V_{OE}$	$I_P = 0\text{ A}$ ; $T_A = 25^\circ\text{C}$ to $125^\circ\text{C}$	-40	$\pm 20$	40	mV
		$I_P = 0\text{ A}$ ; $T_A = -40^\circ\text{C}$ to $25^\circ\text{C}$	-	$\pm 30$	-	mV
Nonlinearity	$E_{LIN}$	Through the full range of $I_P$ ; $T_A = 25^\circ\text{C}$ to $125^\circ\text{C}$	-2	$\pm 0.75$	2	%
		Through the full range of $I_P$ ; $T_A = -40^\circ\text{C}$ to $25^\circ\text{C}$	-	$\pm 0.75$	-	%
<b>LIFETIME DRIFT CHARACTERISTICS</b>						
Total Output Error Including Lifetime Drift	$E_{tot\_drift}$	$I_P = 40\text{ A}$	-	$\pm 6.7$	-	%
Sensitivity Error Including Lifetime Drift	$E_{sens\_drift}$	$I_P = 20\text{ A}$	-	$\pm 3.8$	-	%
Offset Voltage Including Lifetime Drift	$V_{off\_drift}$	$I_P = 0\text{ A}$	-	$\pm 118$	-	mV

[1] Typical values with  $\pm$  are 3 sigma values.

[2] Percentage of  $I_P$ .

# ACS730

## 1 MHz Bandwidth, Galvanically Isolated Current Sensor IC in Small Footprint SOIC8 Package

**xKLCTR-30AU PERFORMANCE CHARACTERISTICS:** Valid over full range of  $T_A$ ,  $V_{CC} = 5\text{ V}$ ,  $C_{BYPASS} = 0.1\ \mu\text{F}$ , unless otherwise specified

Characteristic	Symbol	Test Conditions	Min.	Typ. [1]	Max.	Unit
<b>NOMINAL PERFORMANCE</b>						
Current Sensing Range	$I_{PR}$		0	–	30	A
Sensitivity	Sens		–	120	–	mV/A
Zero Current Output Voltage	$V_{IOUT(Q)}$	$I_P = 0\text{ A}$ , $T_A = 25^\circ\text{C}$	–	0.5	–	V
Zero Current Reference Voltage	$V_{ZCR}$	$T_A = 25^\circ\text{C}$	–	0.5	–	V
<b>ACCURACY PERFORMANCE</b>						
Total Output Error [2]	$E_{TOT}$	$I_P = I_{P(MAX)}$ ; $T_A = 25^\circ\text{C}$ to $125^\circ\text{C}$	–5	$\pm 2.6$	5	%
		$I_P = I_{P(MAX)}$ ; $T_A = -40^\circ\text{C}$ to $25^\circ\text{C}$	–	$\pm 3.7$	–	%
Sensitivity Error	$E_{sens}$	$I_P = I_{P(MAX)}$ ; $T_A = 25^\circ\text{C}$ to $125^\circ\text{C}$	–3.5	$\pm 1.2$	3.5	%
		$I_P = I_{P(MAX)}$ ; $T_A = -40^\circ\text{C}$ to $25^\circ\text{C}$	–	$\pm 3.7$	–	%
Offset Voltage	$V_{OE}$	$I_P = 0\text{ A}$ ; $T_A = 25^\circ\text{C}$ to $125^\circ\text{C}$	–40	$\pm 35$	40	mV
		$I_P = 0\text{ A}$ ; $T_A = -40^\circ\text{C}$ to $25^\circ\text{C}$	–	$\pm 38$	–	mV
Nonlinearity	$E_{LIN}$	Through the full range of $I_P$ ; $T_A = 25^\circ\text{C}$ to $125^\circ\text{C}$	–2	$\pm 1$	2	%
		Through the full range of $I_P$ ; $T_A = -40^\circ\text{C}$ to $25^\circ\text{C}$	–	$\pm 2.3$	–	%
<b>LIFETIME DRIFT CHARACTERISTICS</b>						
Total Output Error Including Lifetime Drift	$E_{tot\_drift}$	$I_P = 40\text{ A}$	–	$\pm 6.7$	–	%
Sensitivity Error Including Lifetime Drift	$E_{sens\_drift}$	$I_P = 20\text{ A}$	–	$\pm 3.8$	–	%
Offset Voltage Including Lifetime Drift	$V_{off\_drift}$	$I_P = 0\text{ A}$	–	$\pm 118$	–	mV

[1] Typical values with  $\pm$  are 3 sigma values.

[2] Percentage of  $I_P$ .



**xKLCTR-40AB PERFORMANCE CHARACTERISTICS:** Valid over full range of  $T_A$ ,  $V_{CC} = 5\text{ V}$ ,  $C_{BYPASS} = 0.1\ \mu\text{F}$ , unless otherwise specified

Characteristic	Symbol	Test Conditions	Min.	Typ. [1]	Max.	Unit
<b>NOMINAL PERFORMANCE</b>						
Current Sensing Range	$I_{PR}$		-40	-	40	A
Sensitivity	Sens		-	50	-	mV/A
Zero Current Output Voltage	$V_{IOUT(Q)}$	$I_P = 0\text{ A}$ , $T_A = 25^\circ\text{C}$	-	2.5	-	V
Zero Current Reference Voltage	$V_{ZCR}$	$T_A = 25^\circ\text{C}$	-	2.5	-	V
<b>ACCURACY PERFORMANCE</b>						
Total Output Error [2]	$E_{TOT}$	$I_P = I_{P(MAX)}$ ; $T_A = 25^\circ\text{C}$ to $125^\circ\text{C}$	-5	$\pm 3$	5	%
		$I_P = I_{P(MAX)}$ ; $T_A = -40^\circ\text{C}$ to $25^\circ\text{C}$	-	$\pm 5$	-	%
Sensitivity Error	$E_{sens}$	$I_P = I_{P(MAX)}$ ; $T_A = 25^\circ\text{C}$ to $125^\circ\text{C}$	-3.5	$\pm 2.5$	3.5	%
		$I_P = I_{P(MAX)}$ ; $T_A = -40^\circ\text{C}$ to $25^\circ\text{C}$	-	$\pm 5$	-	%
Offset Voltage	$V_{OE}$	$I_P = 0\text{ A}$ ; $T_A = 25^\circ\text{C}$ to $125^\circ\text{C}$	-40	$\pm 20$	40	mV
		$I_P = 0\text{ A}$ ; $T_A = -40^\circ\text{C}$ to $25^\circ\text{C}$	-	$\pm 30$	-	mV
Nonlinearity	$E_{LIN}$	Through the full range of $I_P$ ; $T_A = 25^\circ\text{C}$ to $125^\circ\text{C}$	-2	$\pm 0.75$	2	%
		Through the full range of $I_P$ ; $T_A = -40^\circ\text{C}$ to $25^\circ\text{C}$	-	$\pm 0.75$	-	%
<b>LIFETIME DRIFT CHARACTERISTICS</b>						
Total Output Error Including Lifetime Drift	$E_{tot\_drift}$	$I_P = 40\text{ A}$	-	$\pm 6.7$	-	%
Sensitivity Error Including Lifetime Drift	$E_{sens\_drift}$	$I_P = 20\text{ A}$	-	$\pm 3.8$	-	%
Offset Voltage Including Lifetime Drift	$V_{off\_drift}$	$I_P = 0\text{ A}$	-	$\pm 118$	-	mV

[1] Typical values with  $\pm$  are 3 sigma values.

[2] Percentage of  $I_P$ .

**xKLCTR-50AB PERFORMANCE CHARACTERISTICS:** Valid over full range of  $T_A$ ,  $V_{CC} = 5\text{ V}$ ,  $C_{BYPASS} = 0.1\ \mu\text{F}$ , unless otherwise specified

Characteristic	Symbol	Test Conditions	Min.	Typ. [1]	Max.	Unit
<b>NOMINAL PERFORMANCE</b>						
Current Sensing Range	$I_{PR}$		-50	-	50	A
Sensitivity	Sens		-	40	-	mV/A
Zero Current Output Voltage	$V_{IOUT(Q)}$	$I_P = 0\text{ A}$ , $T_A = 25^\circ\text{C}$	-	2.5	-	V
Zero Current Reference Voltage	$V_{ZCR}$	$T_A = 25^\circ\text{C}$	-	2.5	-	V
<b>ACCURACY PERFORMANCE</b>						
Total Output Error [2]	$E_{TOT}$	$I_P = I_{P(MAX)}$ ; $T_A = 25^\circ\text{C}$ to $125^\circ\text{C}$	-5	$\pm 3$	5	%
		$I_P = I_{P(MAX)}$ ; $T_A = -40^\circ\text{C}$ to $25^\circ\text{C}$	-	$\pm 5$	-	%
Sensitivity Error	$E_{sens}$	$I_P = I_{P(MAX)}$ ; $T_A = 25^\circ\text{C}$ to $125^\circ\text{C}$	-3.5	$\pm 3$	3.5	%
		$I_P = I_{P(MAX)}$ ; $T_A = -40^\circ\text{C}$ to $25^\circ\text{C}$	-	$\pm 5$	-	%
Offset Voltage	$V_{OE}$	$I_P = 0\text{ A}$ ; $T_A = 25^\circ\text{C}$ to $125^\circ\text{C}$	-40	$\pm 20$	40	mV
		$I_P = 0\text{ A}$ ; $T_A = -40^\circ\text{C}$ to $25^\circ\text{C}$	-	$\pm 30$	-	mV
Nonlinearity	$E_{LIN}$	Through the full range of $I_P$ ; $T_A = 25^\circ\text{C}$ to $125^\circ\text{C}$	-2	$\pm 0.75$	2	%
		Through the full range of $I_P$ ; $T_A = -40^\circ\text{C}$ to $25^\circ\text{C}$	-	$\pm 0.75$	-	%
<b>LIFETIME DRIFT CHARACTERISTICS</b>						
Total Output Error Including Lifetime Drift	$E_{tot\_drift}$	$I_P = 50\text{ A}$	-	$\pm 6.7$	-	%
Sensitivity Error Including Lifetime Drift	$E_{sens\_drift}$	$I_P = 25\text{ A}$	-	$\pm 3.8$	-	%
Offset Voltage Including Lifetime Drift	$V_{off\_drift}$	$I_P = 0\text{ A}$	-	$\pm 118$	-	mV

[1] Typical values with  $\pm$  are 3 sigma values.

[2] Percentage of  $I_P$ .

**xKLCTR-65AB PERFORMANCE CHARACTERISTICS:** Valid over full range of  $T_A$ ,  $V_{CC} = 5\text{ V}$ ,  $C_{BYPASS} = 0.1\ \mu\text{F}$ , unless otherwise specified

Characteristic	Symbol	Test Conditions	Min.	Typ. [1]	Max.	Unit
<b>NOMINAL PERFORMANCE</b>						
Current Sensing Range	$I_{PR}$		-65	-	65	A
Sensitivity	Sens		-	30	-	mV/A
Zero Current Output Voltage	$V_{IOUT(Q)}$	$I_P = 0\text{ A}$ , $T_A = 25^\circ\text{C}$	-	2.5	-	V
Zero Current Reference Voltage	$V_{ZCR}$	$T_A = 25^\circ\text{C}$	-	2.5	-	V
<b>ACCURACY PERFORMANCE</b>						
Total Output Error [2]	$E_{TOT}$	$I_P = I_{P(MAX)}$ ; $T_A = 25^\circ\text{C}$ to $125^\circ\text{C}$	-5	$\pm 3$	5	%
		$I_P = I_{P(MAX)}$ ; $T_A = -40^\circ\text{C}$ to $25^\circ\text{C}$	-	$\pm 5$	-	%
Sensitivity Error	$E_{sens}$	$I_P = I_{P(MAX)}$ ; $T_A = 25^\circ\text{C}$ to $125^\circ\text{C}$	-3.5	$\pm 3$	3.5	%
		$I_P = I_{P(MAX)}$ ; $T_A = -40^\circ\text{C}$ to $25^\circ\text{C}$	-	$\pm 5$	-	%
Offset Voltage	$V_{OE}$	$I_P = 0\text{ A}$ ; $T_A = 25^\circ\text{C}$ to $125^\circ\text{C}$	-40	$\pm 20$	40	mV
		$I_P = 0\text{ A}$ ; $T_A = -40^\circ\text{C}$ to $25^\circ\text{C}$	-	$\pm 30$	-	mV
Nonlinearity	$E_{LIN}$	Through the full range of $I_P$ ; $T_A = 25^\circ\text{C}$ to $125^\circ\text{C}$	-2	$\pm 0.75$	2	%
		Through the full range of $I_P$ ; $T_A = -40^\circ\text{C}$ to $25^\circ\text{C}$	-	$\pm 0.75$	-	%
<b>LIFETIME DRIFT CHARACTERISTICS</b>						
Total Output Error Including Lifetime Drift	$E_{tot\_drift}$	$I_P = 65\text{ A}$	-	$\pm 6.7$	-	%
Sensitivity Error Including Lifetime Drift	$E_{sens\_drift}$	$I_P = 32\text{ A}$	-	$\pm 3.8$	-	%
Offset Voltage Including Lifetime Drift	$V_{off\_drift}$	$I_P = 0\text{ A}$	-	$\pm 118$	-	mV

[1] Typical values with  $\pm$  are 3 sigma values.

[2] Percentage of  $I_P$ .

**xKLCTR-80AU PERFORMANCE CHARACTERISTICS:** Valid over full range of  $T_A$ ,  $V_{CC} = 5\text{ V}$ ,  $C_{BYPASS} = 0.1\ \mu\text{F}$ , unless otherwise specified

Characteristic	Symbol	Test Conditions	Min.	Typ. [1]	Max.	Unit
<b>NOMINAL PERFORMANCE</b>						
Current Sensing Range	$I_{PR}$		0	–	80	A
Sensitivity	Sens		–	50	–	mV/A
Zero Current Output Voltage	$V_{IOUT(Q)}$	$I_P = 0\text{ A}$ , $T_A = 25^\circ\text{C}$	–	0.5	–	V
Zero Current Reference Voltage	$V_{ZCR}$	$T_A = 25^\circ\text{C}$	–	0.5	–	V
<b>ACCURACY PERFORMANCE</b>						
Total Output Error [2]	$E_{TOT}$	$I_P = I_{P(MAX)}$ ; $T_A = 25^\circ\text{C}$ to $125^\circ\text{C}$	–5	$\pm 1.8$	5	%
		$I_P = I_{P(MAX)}$ ; $T_A = -40^\circ\text{C}$ to $25^\circ\text{C}$	–	$\pm 5$	–	%
Sensitivity Error	$E_{sens}$	$I_P = I_{P(MAX)}$ ; $T_A = 25^\circ\text{C}$ to $125^\circ\text{C}$	–3.5	$\pm 1.5$	3.5	%
		$I_P = I_{P(MAX)}$ ; $T_A = -40^\circ\text{C}$ to $25^\circ\text{C}$	–	$\pm 4.2$	–	%
Offset Voltage	$V_{OE}$	$I_P = 0\text{ A}$ ; $T_A = 25^\circ\text{C}$ to $125^\circ\text{C}$	–40	$\pm 21$	40	mV
		$I_P = 0\text{ A}$ ; $T_A = -40^\circ\text{C}$ to $25^\circ\text{C}$	–	$\pm 27$	–	mV
Nonlinearity	$E_{LIN}$	Through the full range of $I_P$ ; $T_A = 25^\circ\text{C}$ to $125^\circ\text{C}$	–2	$\pm 0.3$	2	%
		Through the full range of $I_P$ ; $T_A = -40^\circ\text{C}$ to $25^\circ\text{C}$	–	$\pm 2.3$	–	%
<b>LIFETIME DRIFT CHARACTERISTICS</b>						
Total Output Error Including Lifetime Drift	$E_{tot\_drift}$	$I_P = 80\text{ A}$	–	$\pm 6.7$	–	%
Sensitivity Error Including Lifetime Drift	$E_{sens\_drift}$	$I_P = 40\text{ A}$	–	$\pm 3.8$	–	%
Offset Voltage Including Lifetime Drift	$V_{off\_drift}$	$I_P = 0\text{ A}$	–	$\pm 118$	–	mV

[1] Typical values with  $\pm$  are 3 sigma values.

[2] Percentage of  $I_P$ .

### CHARACTERISTIC PERFORMANCE xKLCTR-20AB Key Parameters

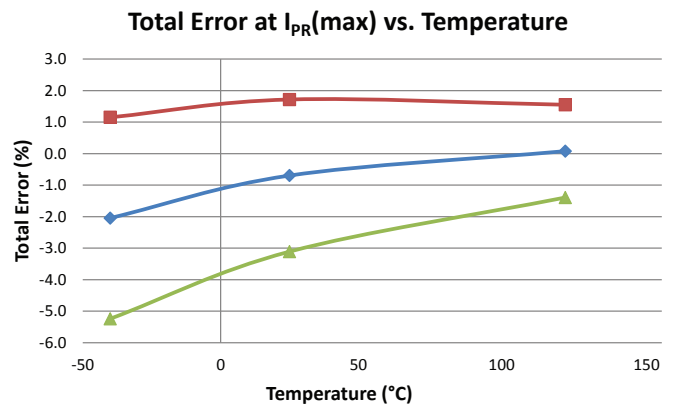
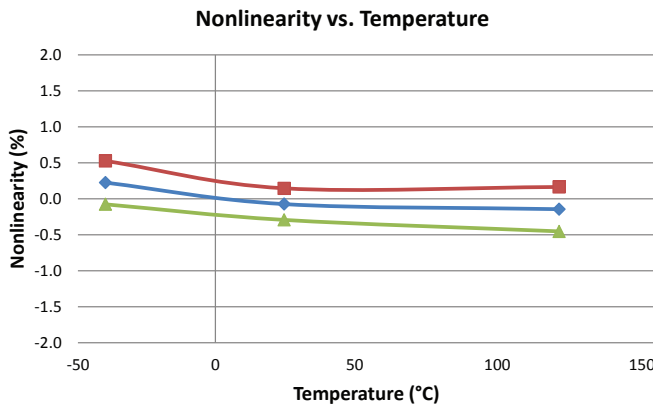
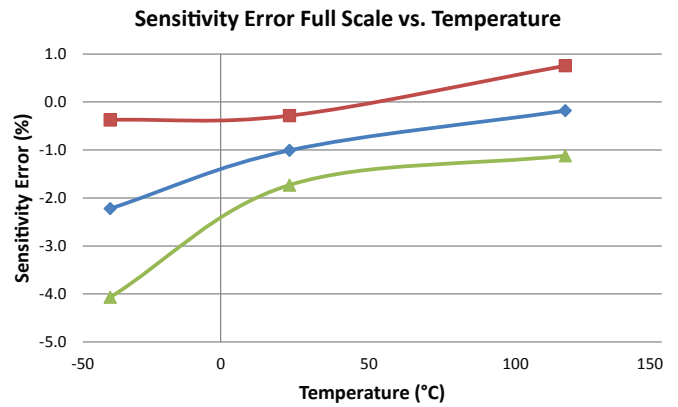
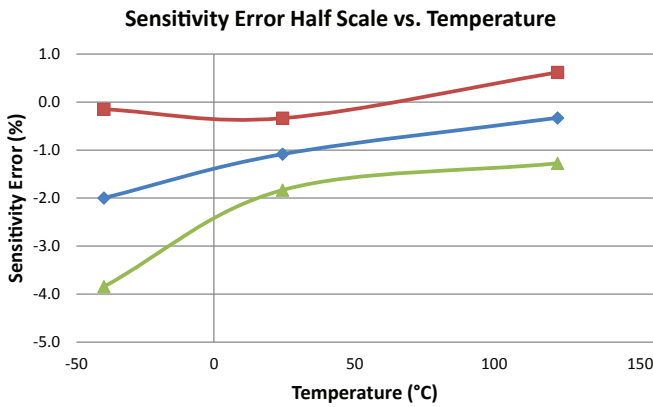
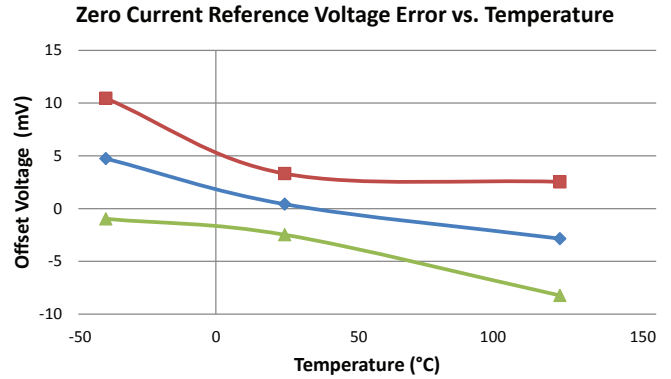
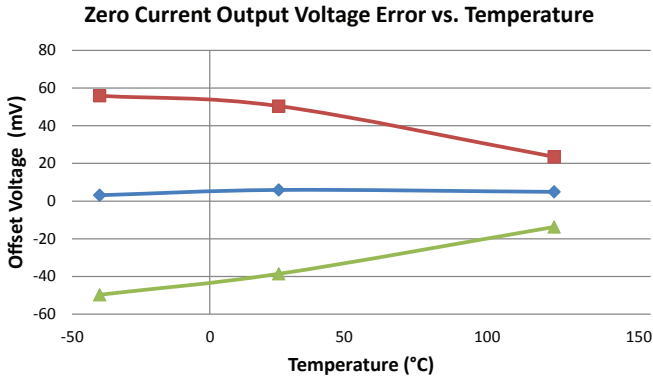

■ +3 Sigma     
 ◆ Average     
 ▲ -3 Sigma

### xKLCTR-30AB Key Parameters

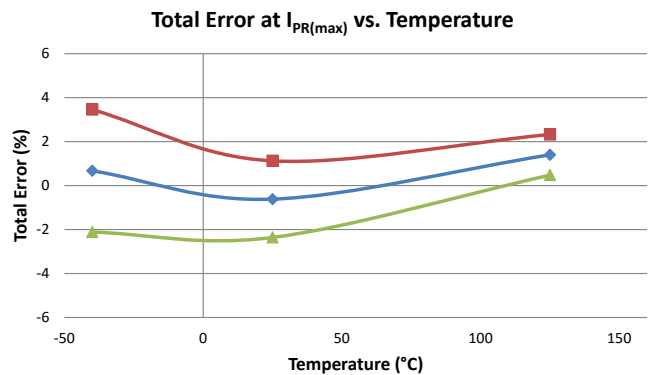
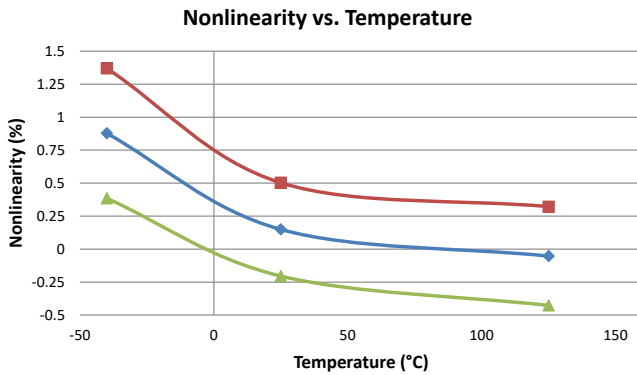
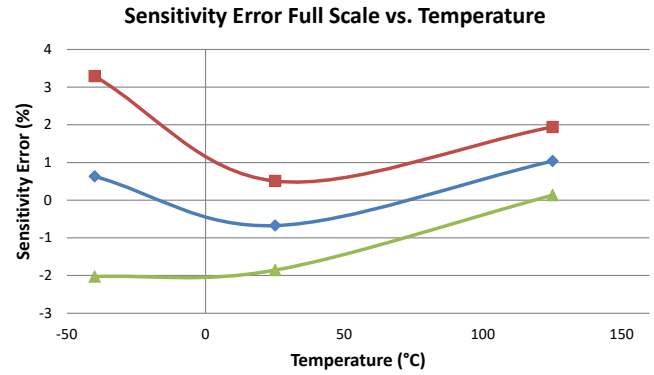
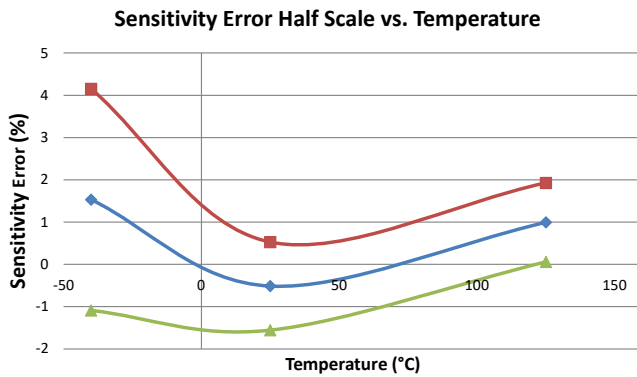
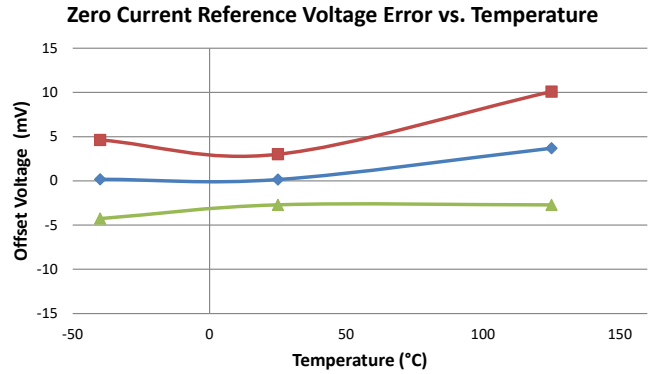
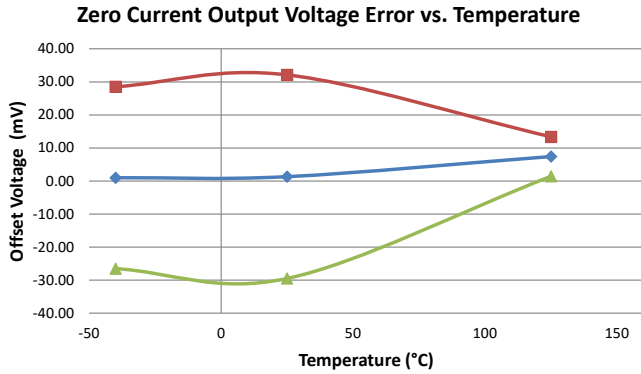

■ +3 Sigma     
 ◆ Average     
 ▲ -3 Sigma

### xKLCTR-30AU Key Parameters

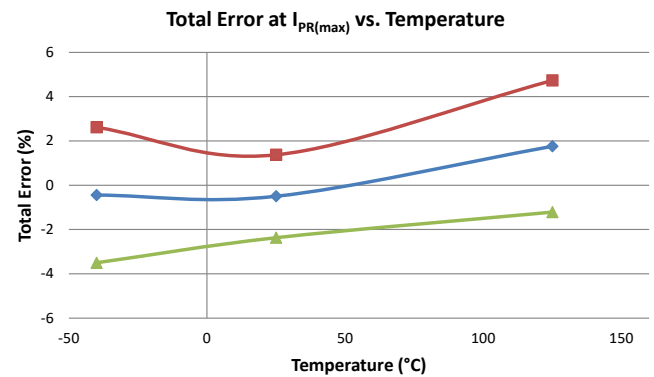
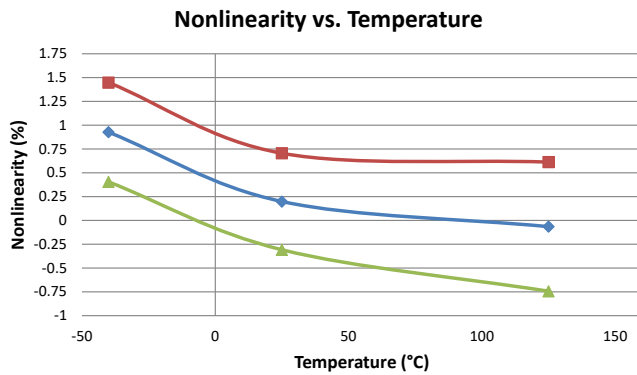
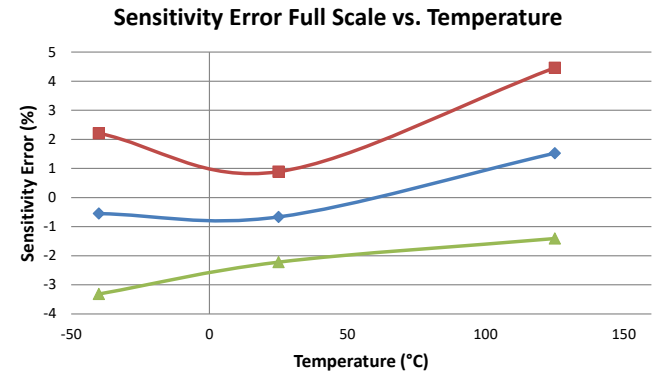
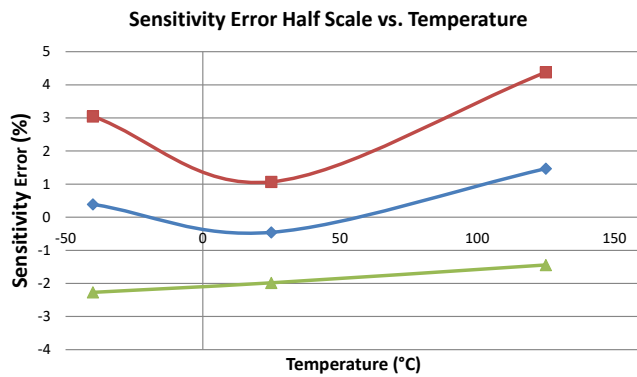
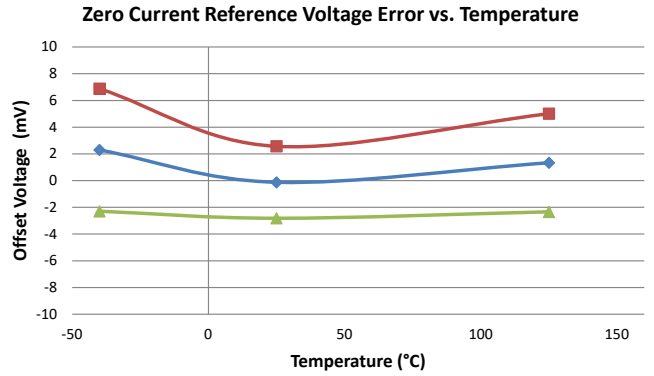
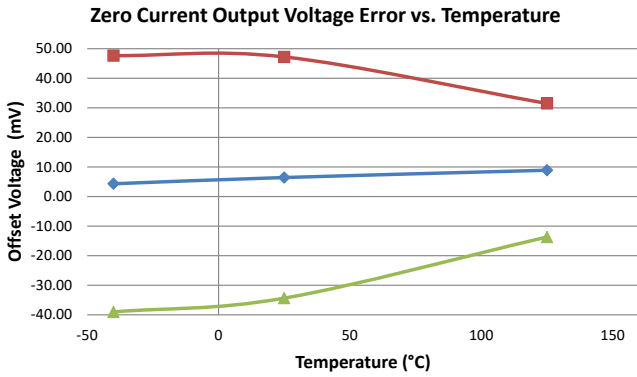

■ +3 Sigma     
 ◆ Average     
 ▲ -3 Sigma

### xKLCTR-40AB Key Parameters

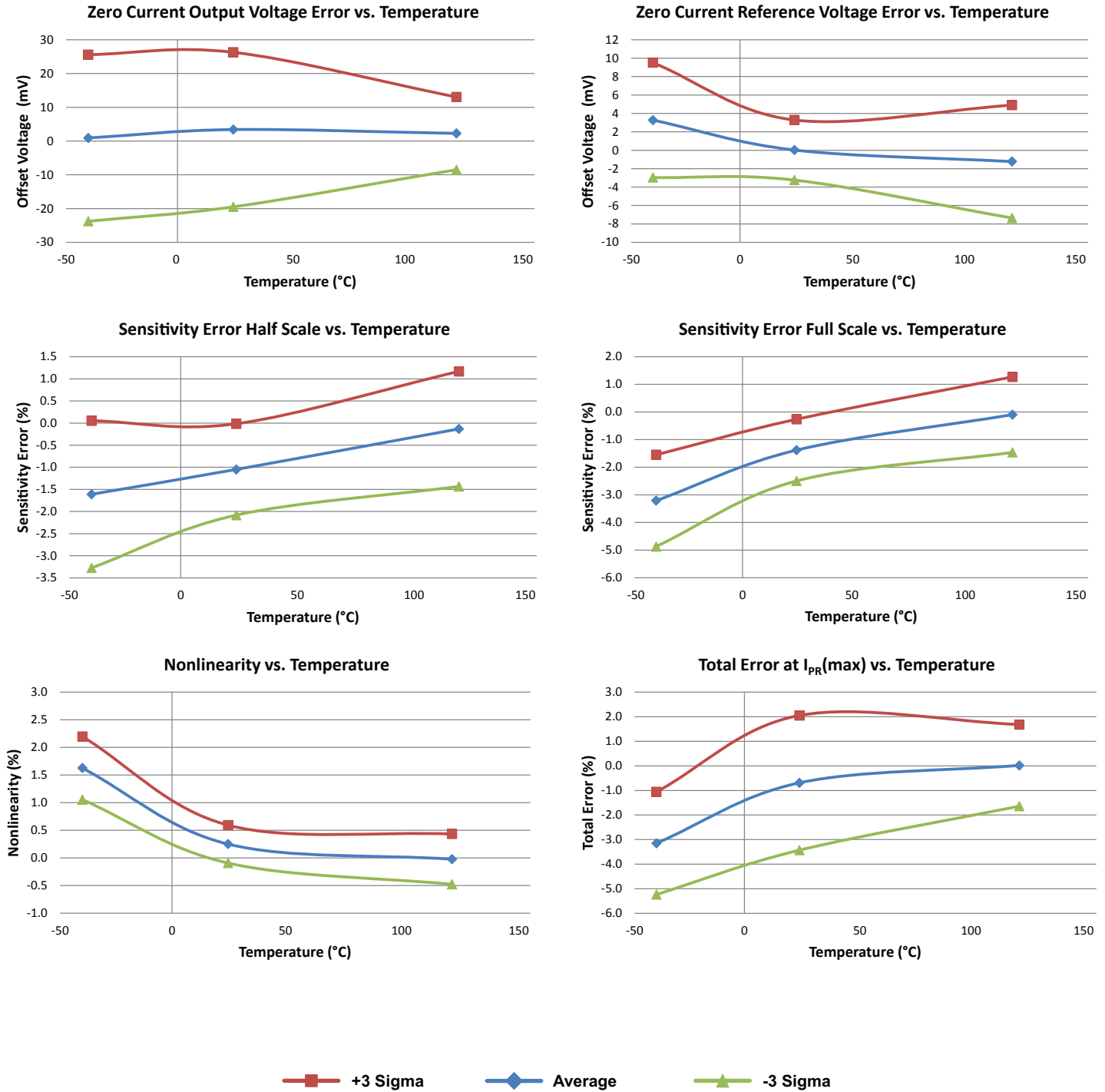



### xKLCTR-50AB Key Parameters

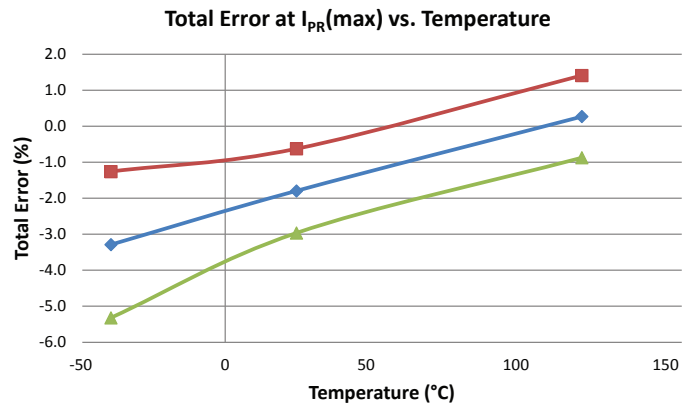
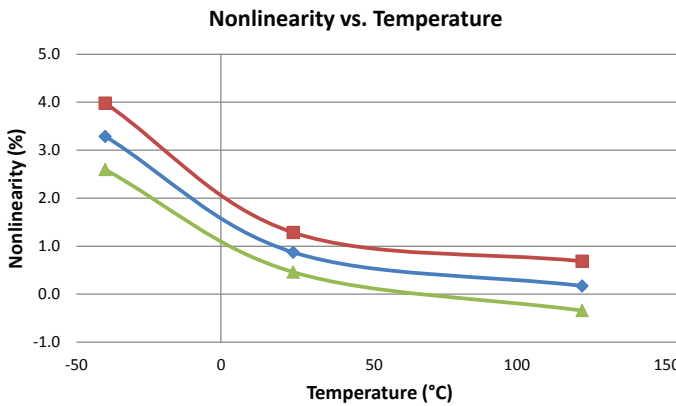
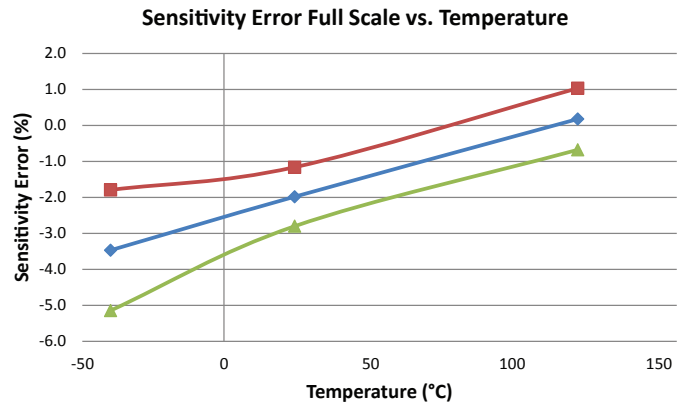
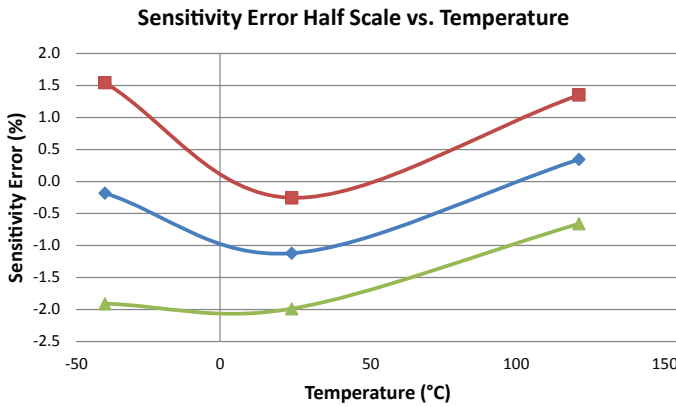
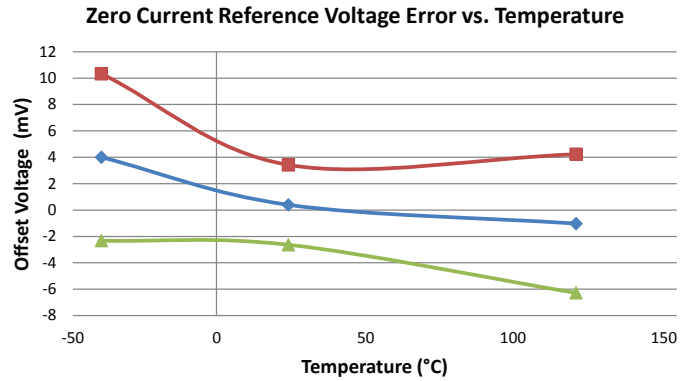
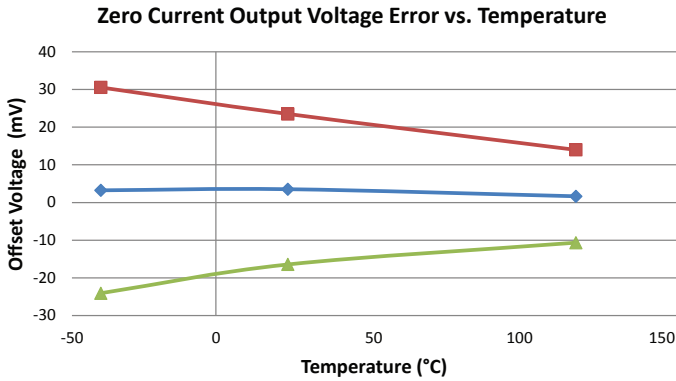

■ +3 Sigma     
 ◆ Average     
 ▲ -3 Sigma

### xKLCTR-65AB Key Parameters

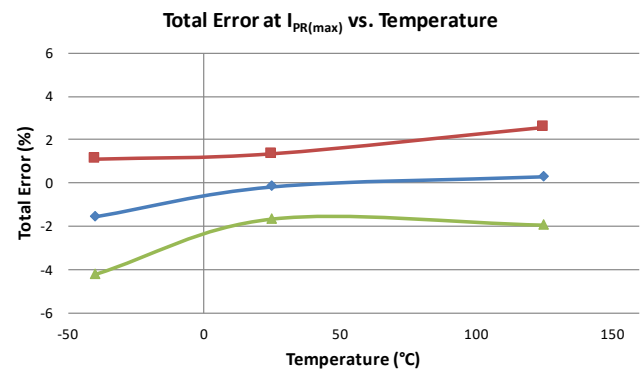
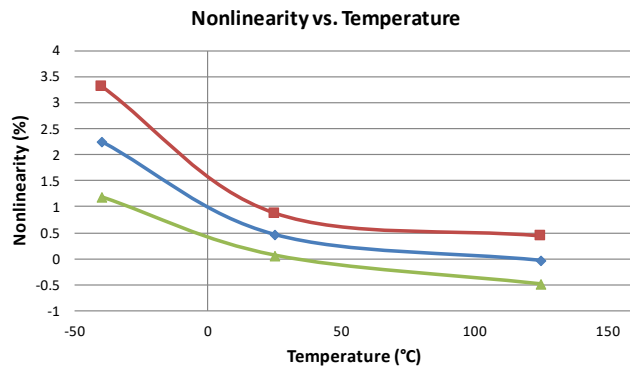
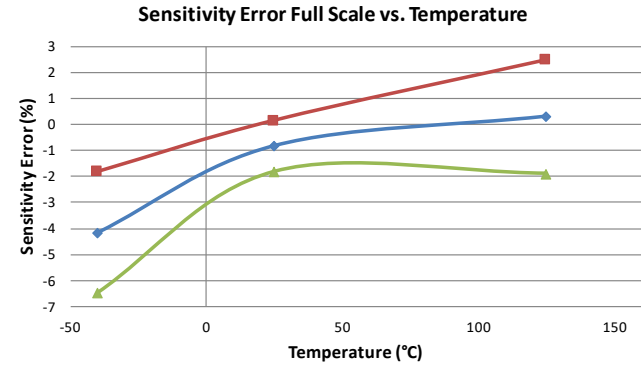
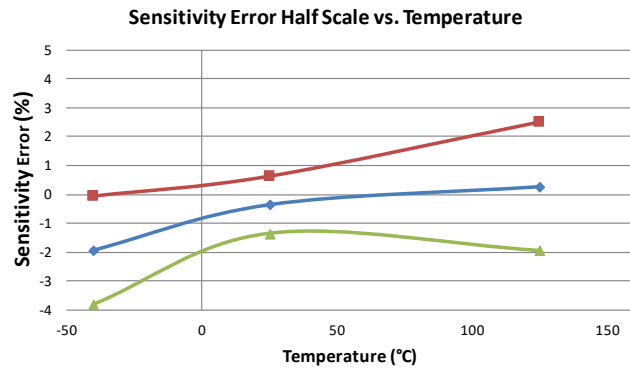
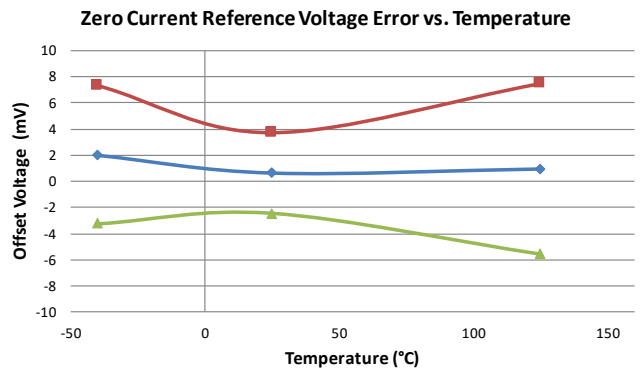
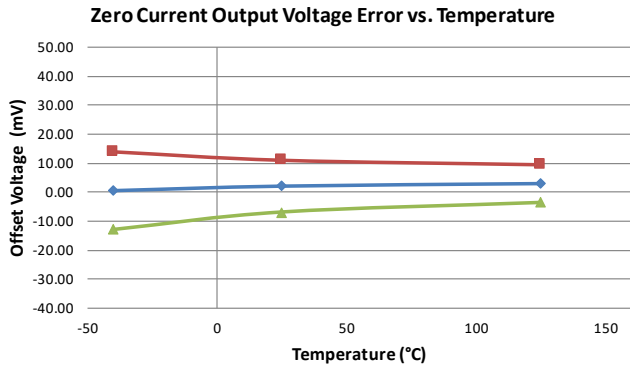

■ +3 Sigma     
 ◆ Average     
 ▲ -3 Sigma

### CHARACTERISTIC PERFORMANCE ACS730 TYPICAL FREQUENCY RESPONSE

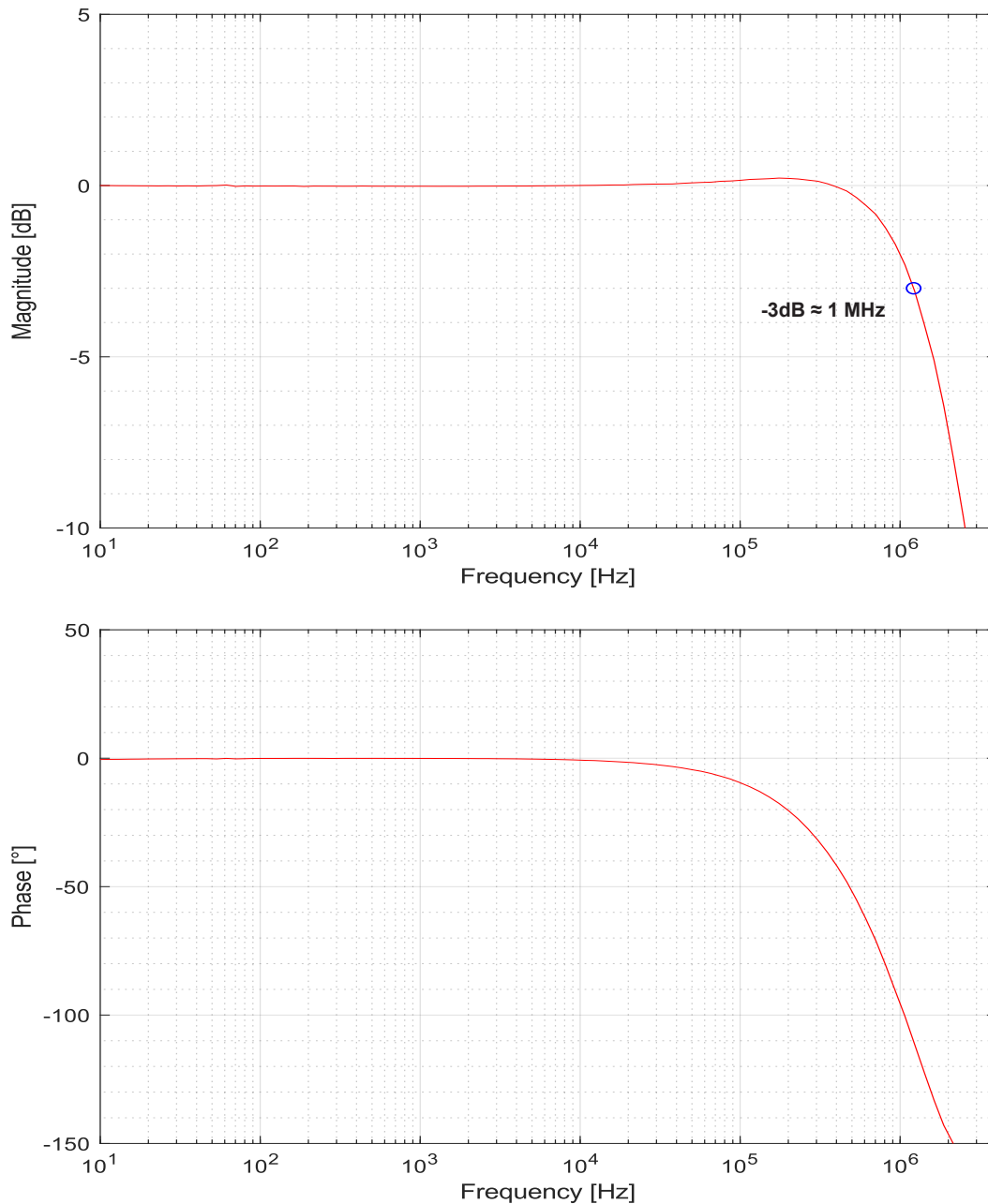

For information regarding bandwidth characterization methods used for the ACS730, see the “Characterizing System Bandwidth” application note (<https://allegromicro.com/en/insights-and-innovations/technical-documents/hall-effect-sensor-ic-publications/an-effective-method-for-characterizing-system-bandwidth-an296169>) on the Allegro website.

## RESPONSE CHARACTERISTICS DEFINITIONS AND PERFORMANCE DATA

### Response Time ( $t_{\text{RESPONSE}}$ )

The time interval between a) when the sensed input current reaches 90% of its final value, and b) when the sensor output reaches 90% of its full-scale value.

### Propagation Delay ( $t_{\text{pd}}$ )

The time interval between a) when the sensed input current reaches 20% of its full-scale value, and b) when the sensor output reaches 20% of its full-scale value.

### Rise Time ( $t_r$ )

The time interval between a) when the sensor reaches 10% of its full-scale value, and b) when it reaches 90% of its full-scale value.

### Output Slew Rate (SR)

The rate of change [ $\text{V}/\mu\text{s}$ ] in the output voltage from a) when the sensor reaches 10% of its full-scale value, and b) when it reaches 90% of its full-scale value.

### Response Time, Propagation Delay, Rise Time, and Output Slew Rate

Applied current step with 10%-90% rise time =  $1 \mu\text{s}$

Test Conditions:  $T_A = 25^\circ\text{C}$ ,  $C_{\text{BYPASS}} = 0.1 \mu\text{F}$ ,  $C_L = 470 \text{ pF}$ ,  $V_{\text{ZCR}} = 1 \text{ nF}$

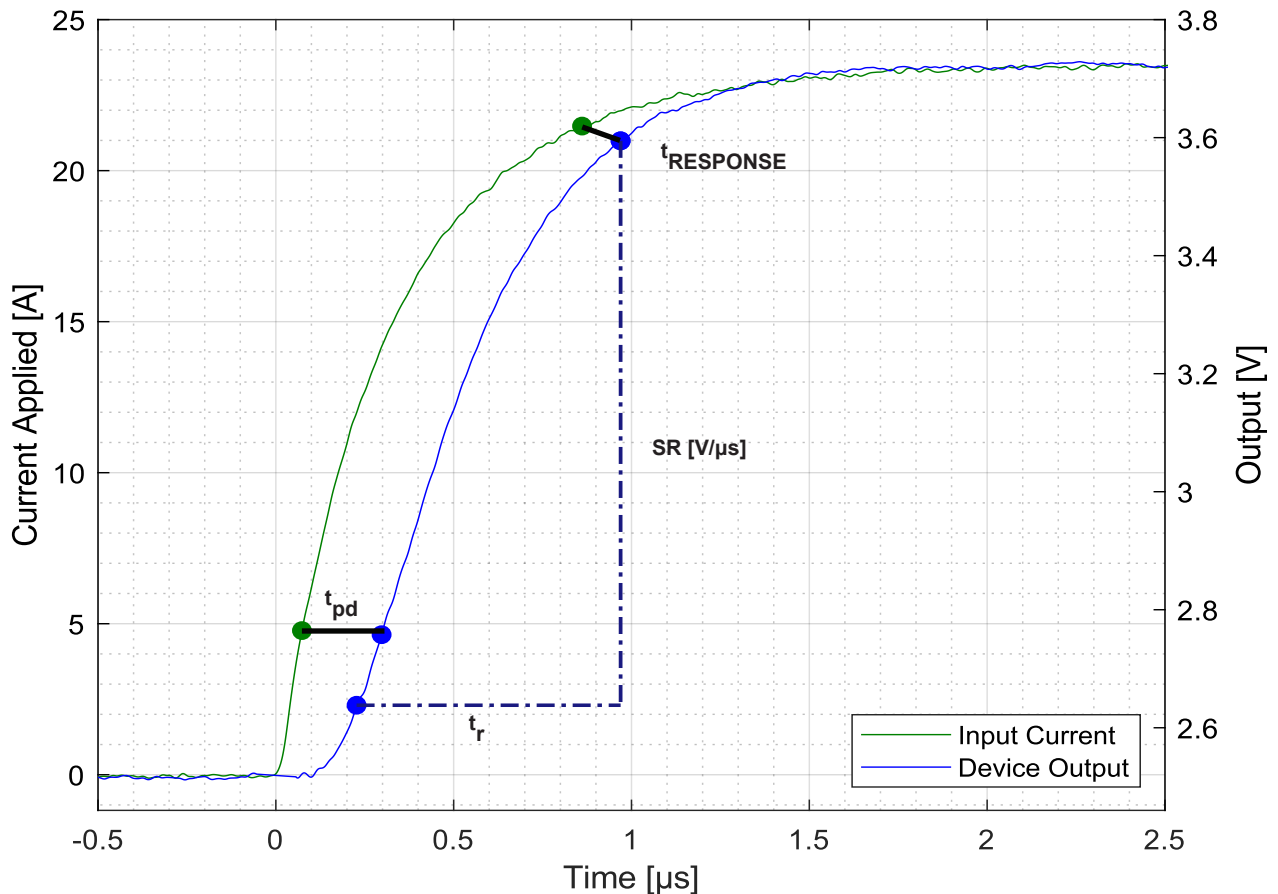

### POWER-ON FUNCTIONAL DESCRIPTION

#### Power-On Time ( $t_{PO}$ )

When the supply is ramped to its operating voltage, the device requires a finite amount of time to power its internal components before responding to an input magnetic field. Power-On Time ( $t_{PO}$ ) is defined as the time interval between a) the power supply has reached its minimum specified operating voltage ( $V_{CC(min)}$ ), and b) when the sensor output has settled within  $\pm 10\%$  of its steady-state value under an applied magnetic field.

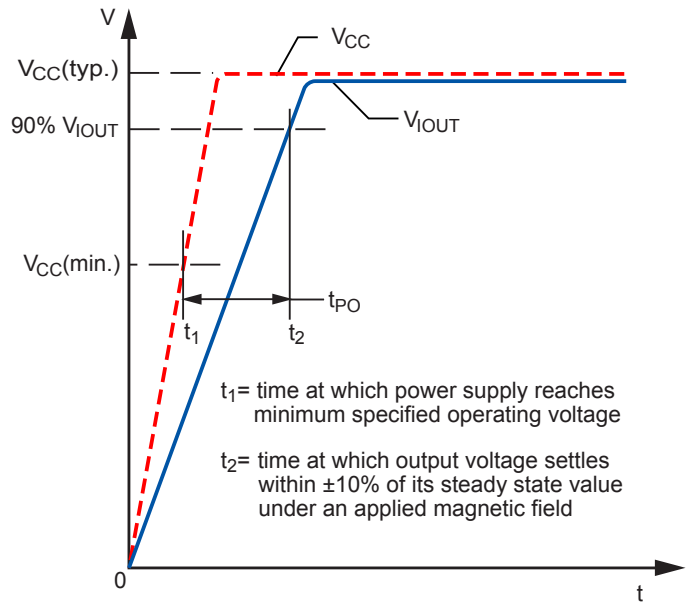

## DEFINITIONS OF ACCURACY CHARACTERISTICS

**Sensitivity (Sens).** The change in sensor IC output in response to a 1 A change through the primary conductor. The sensitivity is the product of the magnetic circuit sensitivity (G/A) (1 G = 0.1 mT) and the linear IC amplifier gain (mV/G). The linear IC amplifier gain is programmed at the factory to optimize the sensitivity (mV/A) for the full-scale current of the device.

**Nonlinearity ( $E_{LIN}$ ).** The nonlinearity is a measure of how linear the output of the sensor IC is over the full current measurement range. The nonlinearity is calculated as:

$$E_{LIN} = \left\{ 1 - \frac{V_{IOUT}(I_R(max)) - V_{IOUT(Q)}}{2 \cdot V_{IOUT}(I_R(max)/2) - V_{IOUT(Q)}} \right\} \cdot 100(\%)$$

**Zero Current Output Voltage ( $V_{IOUT(Q)}$ ).** The output of the sensor when the primary current is zero. For a unipolar supply voltage, it nominally remains at 2.5 V for a bidirectional device. Variation in  $V_{IOUT(Q)}$  can be attributed to the resolution of the Allegro linear IC quiescent voltage trim and thermal drift.

**Offset Voltage ( $V_{OE}$ ).** The deviation of the device output from its ideal quiescent value of 2.5 V due to nonmagnetic causes. To convert this voltage to amperes, divide by the device sensitivity, Sens.

**Total Output Error ( $E_{TOT}$ ).** The difference between the current measurement from the sensor IC and the actual current ( $I_P$ ), relative to the actual current. This is equivalent to the difference between the ideal output voltage and the actual output voltage, divided by the ideal sensitivity, relative to the current flowing through the primary conduction path:

$$E_{TOT}(I_P) = \frac{V_{IOUT\_IDEAL}(I_P) - V_{IOUT}(I_P)}{Sens_{IDEAL} \times I_P} \cdot 100 (\%)$$

The Total Output Error incorporates all sources of error and is a function of  $I_P$ . At relatively high currents,  $E_{TOT}$  will be mostly due to sensitivity error, and at relatively low currents,  $E_{TOT}$  will be mostly due to Offset Voltage ( $V_{OE}$ ). In fact, at  $I_P = 0$ ,  $E_{TOT}$  approaches infinity due to the offset. This is illustrated in Figure 1 and Figure 2. Figure 1 shows a distribution of output voltages versus  $I_P$  at 25°C and across temperature. Figure 2 shows the corresponding  $E_{TOT}$  versus  $I_P$ .

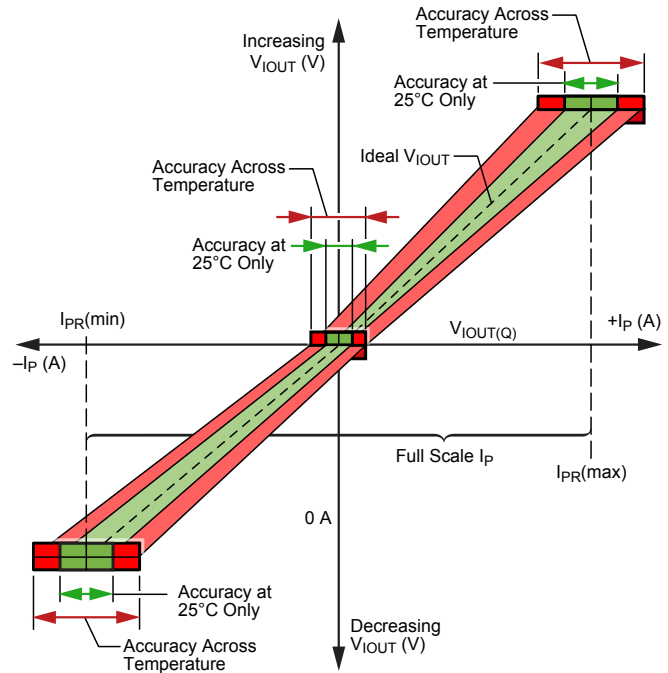

Figure 1: Output Voltage versus Sensed Current

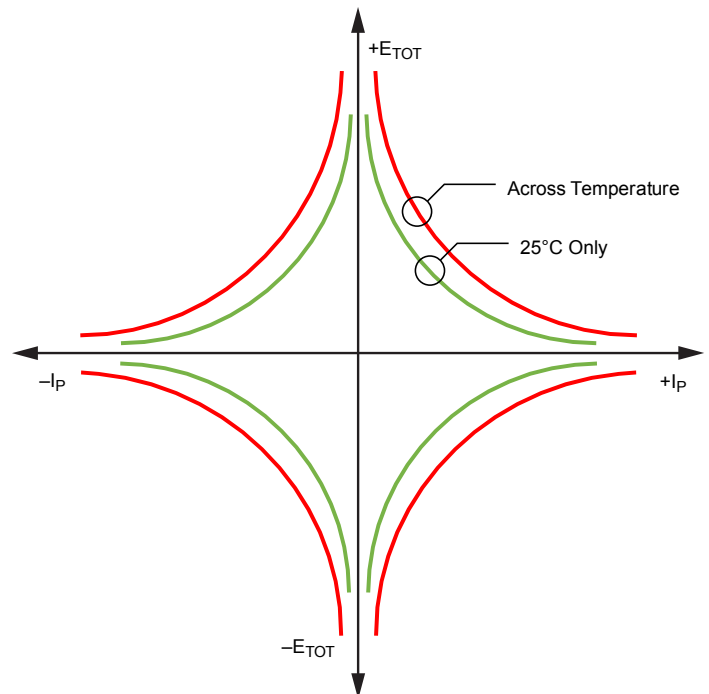

Figure 2: Total Output Error versus Sensed Current

**Power Supply Rejection Ratio (PSRR).** The ratio of the change on V<sub>IOUT</sub> or V<sub>ZCR</sub> to a change in V<sub>CC</sub> in dB.

$$PSRR = 20 \log_{10} \left( \left| \frac{\Delta V_{CC}}{\Delta V_{IOUT}} \right| \right)$$

**Sensitivity Power Supply Rejection Ratio (SPSRR).** The ratio of the percent change in sensitivity from the sensitivity at 5 V to the percent change in V<sub>CC</sub> in dB.

$$SPSRR (V_{CC}) = 20 \log_{10} \left( \left| \frac{Sens_{V_{CCN}} \times (V_{CC} - 5 \text{ V})}{[Sens_{V_{CC}} - Sens_{5V}] \times 5 \text{ V}} \right| \right)$$

An SPSRR value of 15 dB means that a ten percent change in V<sub>CC</sub> (going from 5 to 5.5 V, for example) results in around a 1.75 percent change in sensitivity.

**Offset Power Supply Rejection Ratio (OPSRR).** The ratio of the change in offset to a change in V<sub>CC</sub> in dB.

$$OPSRR = 20 \log_{10} \left( \left| \frac{\Delta V_{CC}}{\Delta V_{OE}} \right| \right)$$

An OPSRR value of 30 dB means that a 500 mV change in V<sub>CC</sub> (going from 5 to 5.5 V, for example) results in around 15 mV of change in the offset.

## APPLICATION INFORMATION

### Impact of External Magnetic Fields

The ACS730 works by sensing the magnetic field created by the current flowing through the package. However, the sensor cannot differentiate between fields created by the current flow and external magnetic fields. This means that external magnetic fields can cause errors in the output of the sensor. Magnetic fields which are perpendicular to the surface of the package affect the output of the sensor, as it only senses fields in that one plane. The error in Amperes can be quantified as:

$$Error (B) = \frac{B}{MCF}$$

where B is the strength of the external field perpendicular to the surface of the package in gauss (G), and MCF is the magnetic coupling factor in gauss/amperes (G/A). Then, multiplying by the sensitivity of the part (Sens) gives the error in mV seen at the output.

For example, an external field of 1 gauss will result in around 0.1 A of error. If the ACS730KLCTR-20AB, which has a nominal sensitivity of 100 mV/A, is being used, that equates to 10 mV of error on the output of the sensor.

External Field (Gauss)	Error (A)	Error (mV)		
		20B	40B	50B
0.5	0.05	5	2.5	2
1	0.1	10	5	4
2	0.2	20	10	8

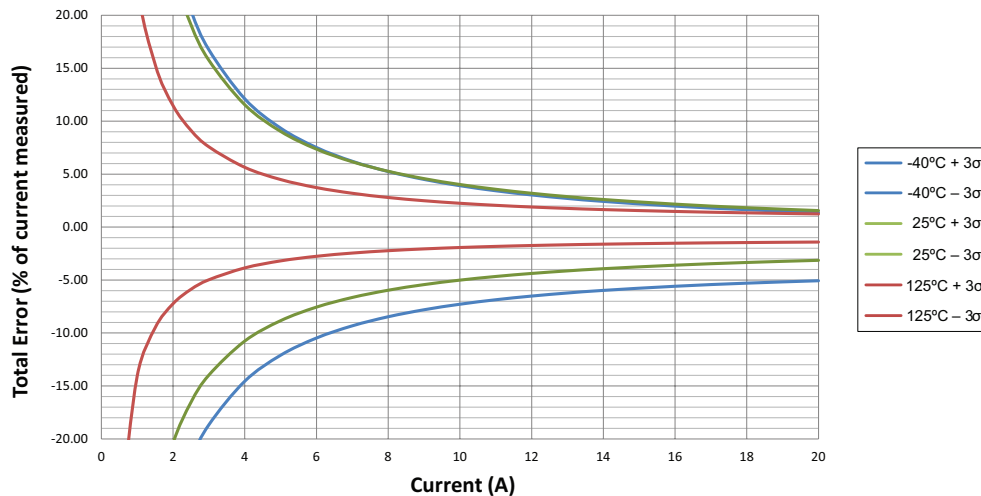

Figure 3: Predicted Total Error as a Function of the Sensed Current for the ACS730KLCTR-20AB

### Estimating Total Error vs. Sensed Current

The Performance Characteristics tables give distribution values ( $\pm 3$  sigma) for Total Error at  $I_p(\text{max})$  and  $I_p(\text{half})$ ; however, one often wants to know what error to expect at a particular current. This can be estimated by using the distribution data for the components of Total Error, Sensitivity Error, and Offset Voltage. The  $\pm 3$  sigma value for Total Error ( $E_{TOT}$ ) as a function of the sensed current ( $I_p$ ) is estimated as:

$$E_{TOT}(I_p) = \sqrt{E_{SENS}^2 + \left(\frac{100 \times V_{OE}}{Sens \times I_p}\right)^2}$$

Here,  $E_{SENS}$  and  $V_{OE}$  are the  $\pm 3$  sigma values for those error terms. If there is an average offset voltage, then the average Total Error is estimated as:

$$E_{TOT_{AVG}}(I_p) = E_{SENS_{AVG}} + \frac{100 \times V_{OE_{AVG}}}{Sens \times I_p}$$

The resulting total error will be a sum of  $E_{TOT}$  and  $E_{TOT_{AVG}}$ . Using these equations and the 3 sigma distributions for Sensitivity Error and Offset Voltage, the Total Error versus sensed current ( $I_p$ ) is below for the ACS730KLCTR-20AB. As expected, as the sensed current ( $I_p$ ) approaches zero, the error in percent goes towards infinity due to division by zero (refer to Figure 3).



## Thermal Rise vs. Primary Current

Self-heating due to the flow of current should be considered during the design of any current sensing system. The sensor, printed circuit board (PCB), and contacts to the PCB will generate heat as current moves through the system.

The thermal response is highly dependent on PCB layout, copper thickness, cooling techniques, and the profile of the injected current. The current profile includes peak current, current “on-time”, and duty cycle. While the data presented in this section was collected with direct current (DC), these numbers may be used to approximate thermal response for both AC signals and current pulses.

The plot in Figure 4 shows the measured rise in steady-state die temperature of the ACS730 versus continuous current at an ambient temperature,  $T_A$ , of 25 °C. The thermal offset curves may be directly applied to other values of  $T_A$ . Conversely, Figure 5 shows the maximum continuous current at a given  $T_A$ . Surges beyond the maximum current listed in Figure 5 are allowed given the maximum junction temperature,  $T_{J(MAX)}$  (165°C), is not exceeded.

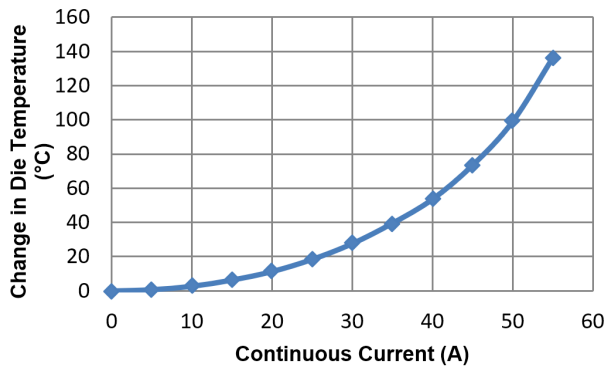

**Figure 4: Self Heating in the LC Package Due to Current Flow**

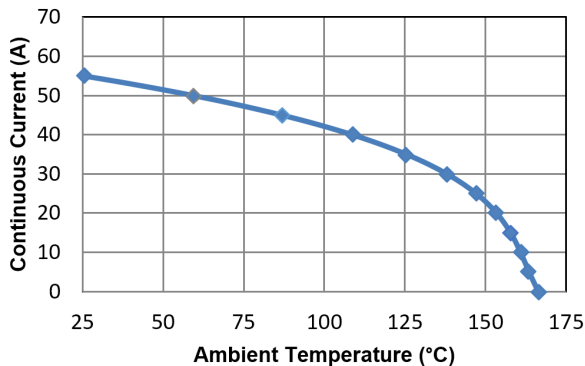
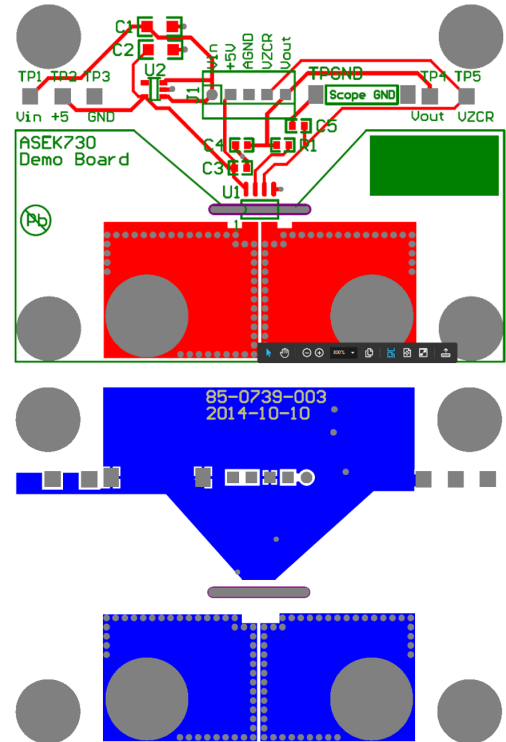

**Figure 5: Maximum Continuous Current at a Given  $T_A$**

The thermal capacity of the ACS730 should be verified by the end user in the application’s specific conditions. The maximum junction temperature,  $T_{J(MAX)}$  (165°C), should not be exceeded. Further information on this application testing is available in the [DC and Transient Current Capability application note](#) on the Allegro website.

## ASEK730 Evaluation Board Layout

Thermal data shown in Figure 4 was collected using the ASEK730 Evaluation Board (TED-85-0739-003). This board includes 1500 mm<sup>2</sup> of 4 oz. copper (0.1388 mm) connected to pins 1 and 2, and to pins 3 and 4, with thermal vias connecting the layers. Top and bottom layers of the PCB are shown below in Figure 6.



**Figure 6: Top and Bottom Layers for ASEK730 Evaluation Board**

Gerber files for the ASEK730 evaluation board are available for download from the Allegro website. See the technical documents section of the [ACS730 device webpage](#).

## PACKAGE OUTLINE DRAWING

### For Reference Only; not for tooling use

(reference Allegro DWG-0000385, Rev. 2 or JEDEC MS-012AA)

Dimensions in millimeters – Not to scale

Dimensions exclusive of mold flash, gate burrs, and dambar protrusions

Exact case and lead configuration at supplier discretion within limits shown

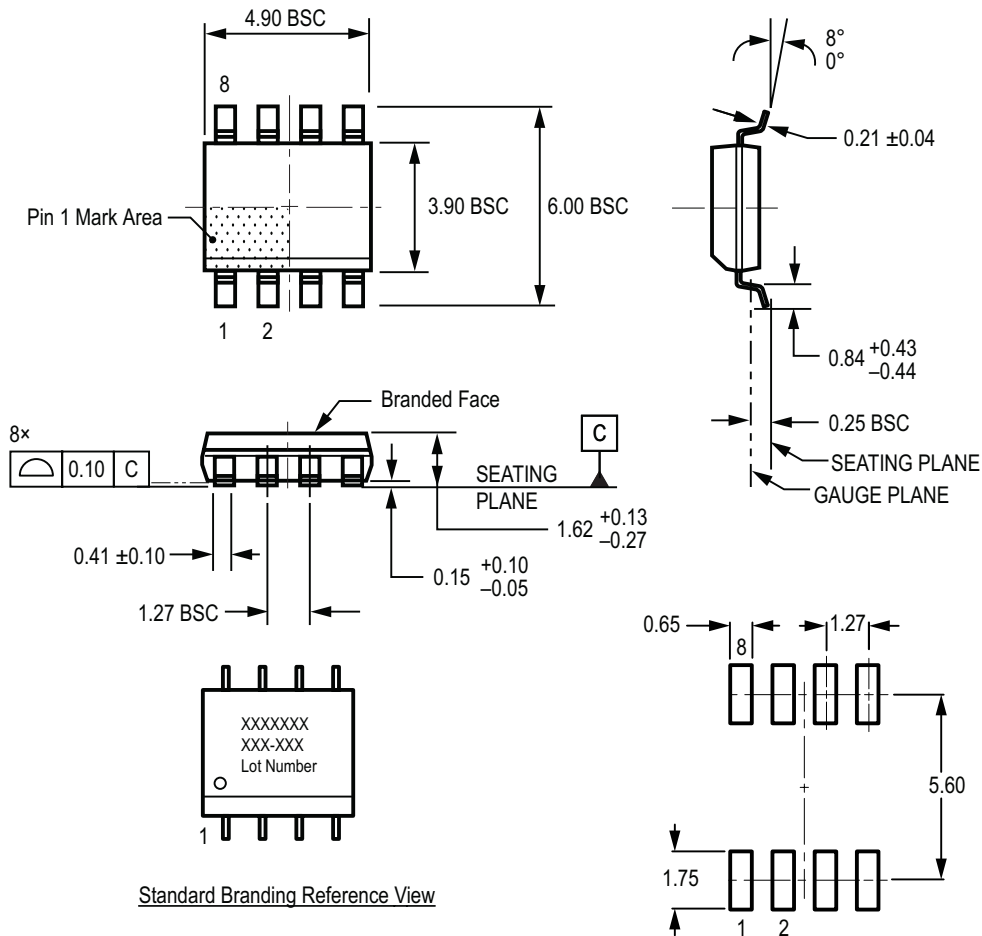

### Standard Branding Reference View

Lines 1, 2 = 8 characters

Line 3 = 5 characters

Line 1: Part Number

Line 2: Temp, Pkg - Amps

Line 3: First 5 Characters of Assembly Lot Number

Belly Brand: Country of Origin, Lot Number

Branding scale and appearance at supplier discretion

### PCB Layout Reference View

Reference land pattern layout

(reference IPC7351 SOIC127P600X175-8M);

all pads a minimum of 0.20 mm from all adjacent pads; adjust as necessary to meet application process requirements and PCB layout tolerances.

Figure 10: Package LC, 8-Pin SOICN

## Revision History

Number	Date	Description
–	February 29, 2016	Initial release
1	August 19, 2016	Updated Isolation Characteristics table and added Frequency Response charts
2	February 28, 2017	Updated Absolute Maximum Ratings table
3	August 29, 2017	Added “-40AU” and “-80AU” product options; updated Isolation Characteristics table.
4	April 30, 2018	Added “-30AB” product option
5	May 22, 2018	Added “-30AU” product option; updated “-40AU” and “-80AU” performance characteristics; added certificate marks
6	July 30, 2018	Added Propagation Delay characteristic (page 5)
7	October 16, 2018	Added “-65AB” product option; updated “-80AU” Lifetime Drift test conditions
8	December 13, 2018	Updated certificate number
9	August 16, 2019	Added Maximum Continuous Current to Absolute Maximum Ratings table (page 2), ESD ratings table (page 2), and thermal data section (page 23)
10	March 29, 2021	Added footnote [1] in the Selection Guide (page 2); updated ESD Ratings table test conditions (page 2); added Comparative Tracking Index to Isolation Characteristics table (page 3); updated Thermal Characteristics table test conditions and footnotes (page 3); added Primary Conductor Inductance and Output Slew Rate characteristics (page 5); updated Reference Resistive Load test condition (page 5); moved Zero Current Reference voltage from Common Electrical Characteristics to Performance Characteristics tables (pages 6-13); updated Typical Frequency Response (page 20); updated Response Characteristics Definitions and Performance Data (page 21); added Power-On Functional Description page (page 22); updated Standard Branding Reference View (page 27).
11	April 5, 2022	Updated package drawing (page 27)
12	May 17, 2022	Added “-S” lead free part variants; removed non-production part variants; removed ESD Ratings table; removed Maximum Continuous Current; minor editorial updates

Copyright 2022, Allegro MicroSystems.

Allegro MicroSystems reserves the right to make, from time to time, such departures from the detail specifications as may be required to permit improvements in the performance, reliability, or manufacturability of its products. Before placing an order, the user is cautioned to verify that the information being relied upon is current.

Allegro’s products are not to be used in any devices or systems, including but not limited to life support devices or systems, in which a failure of Allegro’s product can reasonably be expected to cause bodily harm.

The information included herein is believed to be accurate and reliable. However, Allegro MicroSystems assumes no responsibility for its use; nor for any infringement of patents or other rights of third parties which may result from its use.

Copies of this document are considered uncontrolled documents.

For the latest version of this document, visit our website:

[www.allegromicro.com](http://www.allegromicro.com)