

**FEATURES**

- 5 kV rms isolated CAN transceiver**
- Integrated V<sub>+</sub> linear regulator**
- Bus side powered by V<sub>+</sub> and V<sub>-</sub>**
- 11 V to 25 V operation on V<sub>+</sub>**
- 5 V or 3.3 V operation on V<sub>DD1</sub>**
- Complies with ISO 11898 standard**
- High speed data rates up to 1 Mbps**
- Short-circuit protection on bus pins**
- Integrated bus miswire protection**
- Unpowered nodes do not disturb the bus**
- 110 or more nodes on the bus**
- Thermal shutdown protection**
- High common-mode transient immunity: >25 kV/μs**
- Safety and regulatory approvals**
  - UL recognition
  - 5000 V<sub>RMS</sub> for 1 minute per UL 1577
  - VDE Certificates of Conformity
  - DIN V VDE V 0884-10 (VDE V 0884-10):2006-12
  - V<sub>IORM</sub> = 846 V peak
- Industrial operating temperature range: -40°C to +85°C**
- Wide body, 16-lead SOIC package**

**APPLICATIONS**

- CAN data buses
- Industrial field networks
- DeviceNet applications

**GENERAL DESCRIPTION**

The [ADM3052](#) is an isolated controller area network (CAN) physical layer transceiver with a V<sub>+</sub> integrated linear regulator. The [ADM3052](#) complies with the ISO 11898 standard.

The device employs Analog Devices, Inc., *iCoupler*® technology to combine a 3-channel isolator, a CAN transceiver, and a linear regulator into a single package. The power is isolated between a single 3.3 V or 5 V supply on V<sub>DD1</sub>, the logic side, and a single 24 V supply provided on V<sub>+</sub>, the bus side.

The [ADM3052](#) creates an isolated interface between the CAN protocol controller and the physical layer bus. It is capable of running at data rates up to 1 Mbps.

The device has integrated miswire protection on the bus pins, V<sub>+</sub>, V<sub>-</sub>, CANH, and CANL.

The device has current-limiting and thermal shutdown features to protect against output short circuits and situations where the bus may be shorted to ground or power terminals. The device is fully specified over the industrial temperature range and is available in a 16-lead, wide-body SOIC package.

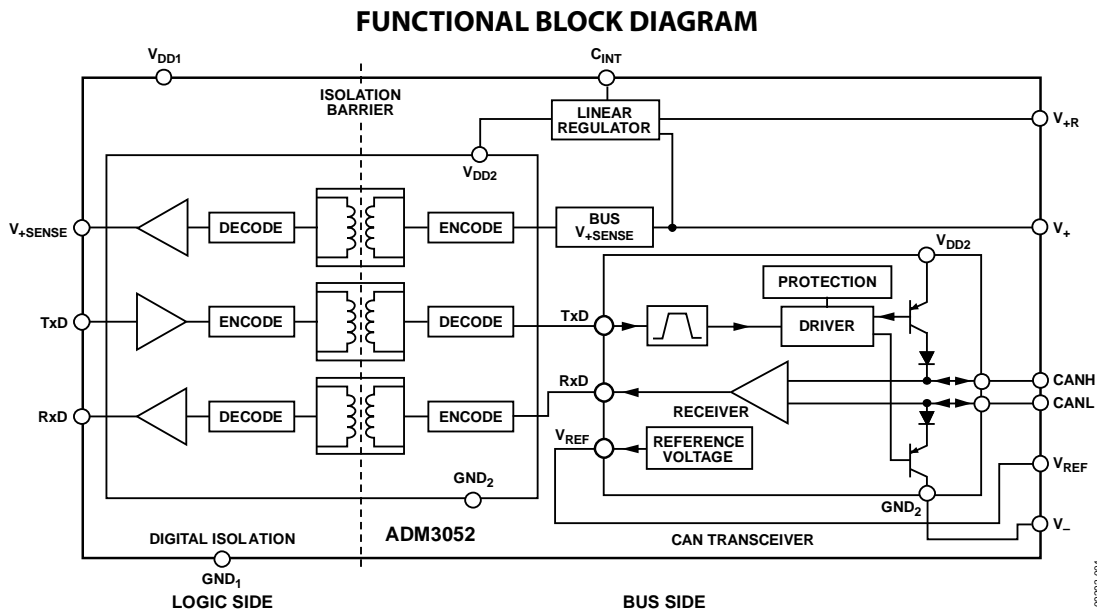

Figure 1.

Rev. B

[Document Feedback](#)

Information furnished by Analog Devices is believed to be accurate and reliable. However, no responsibility is assumed by Analog Devices for its use, nor for any infringements of patents or other rights of third parties that may result from its use. Specifications subject to change without notice. No license is granted by implication or otherwise under any patent or patent rights of Analog Devices. Trademarks and registered trademarks are the property of their respective owners.

One Technology Way, P.O. Box 9106, Norwood, MA 02062-9106, U.S.A.  
 Tel: 781.329.4700 ©2011–2016 Analog Devices, Inc. All rights reserved.  
[Technical Support](#) [www.analog.com](http://www.analog.com)

## TABLE OF CONTENTS

Features .....	1	Test Circuits.....	12
Applications.....	1	Switching Characteristics .....	13
General Description .....	1	Circuit Description.....	14
Functional Block Diagram .....	1	CAN Transceiver Operation .....	14
Revision History .....	2	Electrical Isolation.....	14
Specifications.....	3	Truth Tables.....	14
Timing Specifications .....	4	Thermal Shutdown .....	16
Regulatory Information.....	4	Linear Regulator .....	16
Insulation and Safety-Related Specifications.....	4	Magnetic Field Immunity.....	16
VDE 0884 Insulation Characteristics .....	5	Applications Information .....	17
Absolute Maximum Ratings.....	6	Typical Applications.....	17
ESD Caution.....	6	DeviceNet™ and the ADM3052 CAN Transceiver.....	17
Pin Configuration and Function Descriptions.....	7	Outline Dimensions .....	18
Typical Performance Characteristics .....	8	Ordering Guide .....	18

## REVISION HISTORY

### 6/2016—Rev. A to Rev. B

Changes to Tracking Resistance (Comparative Tracking Index) Parameter and Isolation Group Parameter, Table 4 .....	4
Added Table 7; Renumbered Sequentially .....	6

### 12/2012—Rev. 0 to Rev. A

Changes to Features Section (Approvals No Longer Pending) ..	1
Changes to Table 3 Caption (Approvals No Longer Pending) ...	4
Changed VDE 0884 Insulation Characteristics (Pending) Section to VDE 0884 Insulation Characteristics Section .....	5
Changes to Table Summary Text Prior to Table 5.....	5
Added DeviceNet™ and the ADM3052 CAN Transceiver Section.....	17

### 6/2011—Revision 0: Initial Version

## SPECIFICATIONS

All voltages are relative to their respective ground;  $3.0\text{ V} \leq V_{DD1} \leq 5.5\text{ V}$ ,  $T_A = -40^\circ\text{C}$  to  $+85^\circ\text{C}$ ,  $V_+ = 11\text{ V}$  to  $25\text{ V}$ , unless otherwise noted.

Table 1.

Parameter	Symbol	Min	Typ	Max	Unit	Test Conditions
<b>SUPPLY CURRENT</b>						
Power Supply Current Logic Side TxD/RxD Data Rate 1 Mbps	$I_{DD1}$		0.7	2	mA	
Power Supply Current Bus Side Recessive State	$I_+$			10	mA	$R_L = 60\ \Omega$ , see Figure 26
Dominant State	$I_+$		64	75	mA	$R_L = 60\ \Omega$ , see Figure 26
TxD/RxD Data Rate 1 Mbps	$I_+$		48	55	mA	$R_L = 60\ \Omega$ , see Figure 26
<b>EXTERNAL RESISTOR</b>						
Resistance	$R_P$	297	300	303	$\Omega$	
Power Rating		0.75			W	
<b>DRIVER</b>						
Logic Inputs						
Input Voltage High	$V_{IH}$	$0.7 V_{DD1}$			V	TxD
Input Voltage Low	$V_{IL}$			$0.25 V_{DD1}$	V	TxD
CMOS Logic Input Currents	$I_{IH}, I_{IL}$			500	$\mu\text{A}$	TxD
Differential Outputs						
Recessive Bus Voltage	$V_{CANL}, V_{CANH}$	2.0		3.0	V	$V_{TxD} = \text{high}$ , $R_L = \infty$ , see Figure 23
CANH Output Voltage	$V_{CANH}$	2.75		4.5	V	$V_{TxD} = \text{low}$ , see Figure 23
CANL Output Voltage	$V_{CANL}$	0.5		2.0	V	$V_{TxD} = \text{low}$ , see Figure 23
Differential Output Voltage	$V_{OD}$	1.5		3.0	V	$V_{TxD} = \text{low}$ , $R_L = 45\ \Omega$ , see Figure 23
	$V_{OD}$	-500		+50	mV	$V_{TxD} = \text{high}$ , $R_L = \infty$ , see Figure 23
Short-Circuit Current, CANH	$I_{SCCANH}$			-200	mA	$V_{CANH} = -5\text{ V}$
			-100		mA	$V_{CANH} = -36\text{ V}$
Short-Circuit Current, CANL	$I_{SCCANL}$			200	mA	$V_{CANL} = 36\text{ V}$
<b>RECEIVER</b>						
Differential Inputs						
Voltage Recessive	$V_{IDR}$	-1.0		+0.5	V	$-7\text{ V} < V_{CANL}, V_{CANH} < 12\text{ V}$ , see Figure 24, $C_L = 15\text{ pF}$
Voltage Dominant	$V_{IDD}$	0.9		5.0	V	$-7\text{ V} < V_{CANL}, V_{CANH} < 12\text{ V}$ , see Figure 24, $C_L = 15\text{ pF}$
Input Voltage Hysteresis	$V_{HYS}$		150		mV	See Figure 24
CANH, CANL Input Resistance	$R_{IN}$	5		25	k $\Omega$	
Differential Input Resistance	$R_{DIFF}$	20		100	k $\Omega$	
Logic Outputs						
Output Low Voltage	$V_{OL}$		0.2	0.4	V	$I_{OUT} = 1.5\text{ mA}$
Output High Voltage	$V_{OH}$	$V_{DD1} - 0.3$	$V_{DD1} - 0.2$		V	$I_{OUT} = -1.5\text{ mA}$
Short-Circuit Current	$I_{OS}$	7		85	mA	$V_{OUT} = \text{GND}_1$ or $V_{DD1}$
<b>VOLTAGE REFERENCE</b>						
Reference Output Voltage	$V_{REF}$	2.025		3.025	V	$ I_{REF} = 50\ \mu\text{A} $
<b>BUS VOLTAGE SENSE</b>						
$V_{+SENSE}$ Output Voltage Low	$V_{OL}$		0.2	0.4	V	$I_{O+SENSE} = 1.5\text{ mA}$
$V_{+SENSE}$ Output Voltage High	$V_{OH}$	$V_{DD1} - 0.3$	$V_{DD1} - 0.2$		V	$I_{O+SENSE} = -1.5\text{ mA}$
Threshold Voltage	$V_{+SENSETH}$	7.0		10	V	
<b>COMMON-MODE TRANSIENT IMMUNITY<sup>1</sup></b>						
		25			kV/ $\mu\text{s}$	$V_{CM} = 1\text{ kV}$ , transient magnitude = 800 V

<sup>1</sup> CM is the maximum common-mode voltage slew rate that can be sustained while maintaining specification-compliant operation.  $V_{CM}$  is the common-mode potential difference between the logic and bus sides. The transient magnitude is the range over which the common mode is slewed. The common-mode voltage slew rates apply to both rising and falling common-mode voltage edges.

**TIMING SPECIFICATIONS**

All voltages are relative to their respective ground;  $3.0\text{ V} \leq V_{DD1} \leq 5.5\text{ V}$ ,  $T_A = -40^\circ\text{C}$  to  $+85^\circ\text{C}$ ,  $V_+ = 11\text{ V}$  to  $25\text{ V}$ , unless otherwise noted.

Table 2.

Parameter	Symbol	Min	Typ	Max	Unit	Test Conditions
<b>DRIVER</b>						
Maximum Data Rate		1			Mbps	
Propagation Delay from TxD On to Bus Active	$t_{onTxD}$			90	ns	See Figure 25 and Figure 27, $R_L = 60\ \Omega$ , $C_L = 100\text{ pF}$
Propagation Delay from TxD Off to Bus Inactive	$t_{offTxD}$			120	ns	See Figure 25 and Figure 27, $R_L = 60\ \Omega$ , $C_L = 100\text{ pF}$
<b>RECEIVER</b>						
Propagation Delay from TxD On to Receiver Active	$t_{onRxD}$			200	ns	See Figure 25 and Figure 27, $R_L = 60\ \Omega$ , $C_L = 100\text{ pF}$
Propagation Delay from TxD Off to Receiver Inactive	$t_{offRxD}$			250	ns	See Figure 25 and Figure 27, $R_L = 60\ \Omega$ , $C_L = 100\text{ pF}$
<b>POWER-UP</b>						
Enable Time, $V_+$ High to $V_{+SENSE}$ Low	$t_{SE}$			300	$\mu\text{s}$	See Figure 29
Disable Time, $V_+$ Low to $V_{+SENSE}$ High	$t_{SD}$			10	ms	See Figure 29

**REGULATORY INFORMATION**

Table 3. ADM3052 Approvals

Organization	Approval Type	Notes
UL	Recognized under the component recognition program of Underwriters Laboratories, Inc.	In accordance with UL 1577, each ADM3052 is proof tested by applying an insulation test voltage $\geq 6000\text{ V rms}$ for 1 second (current leakage detection limit = $10\ \mu\text{A}$ )
VDE	Certified according to DIN V VDE V 0884-10 (VDE V 0884-10):2006-12	In accordance with DIN V VDE V 0884-10, each ADM3052 is proof tested by applying an insulation test voltage $\geq 1590\text{ V peak}$ for 1 second (partial discharge detection limit = $5\text{ pC}$ )

**INSULATION AND SAFETY-RELATED SPECIFICATIONS**

Table 4.

Parameter	Symbol	Value	Unit	Conditions
Rated Dielectric Insulation Voltage		5000	V rms	1-minute duration
Minimum External Air Gap (Clearance)	L(I01)	7.7	mm	Measured from input terminals to output terminals, shortest distance through air
Minimum External Tracking (Creepage)	L(I02)	7.6	mm	Measured from input terminals to output terminals, shortest distance along body
Minimum Internal Gap (Internal Clearance)		0.017 min	mm	Insulation distance through insulation
Tracking Resistance (Comparative Tracking Index)	CTI	>400	V	DIN IEC 112/VDE 0303-1
Isolation Group		II		Material group (DIN VDE 0110)

**VDE 0884 INSULATION CHARACTERISTICS**

This isolator is suitable for reinforced electrical isolation within the safety limit data. Maintenance of the safety data must be ensured by means of protective circuits. An asterisk (\*) on packages denotes DIN V VDE V 0884-10 approval.

**Table 5.**

Description	Test Conditions	Symbol	Characteristic	Unit
<b>CLASSIFICATIONS</b>				
Installation Classification per DIN VDE 0110 for Rated Mains Voltage			I to IV	
≤150 V rms			I to III	
≤300 V rms			I to II	
≤400 V rms			40/85/21	
Climatic Classification			2	
Pollution Degree	DIN VDE 0110			
<b>VOLTAGE</b>				
Maximum Working Insulation Voltage		$V_{IORM}$	846	V peak
Input-to-Output Test Voltage, Method B1	$V_{IORM} \times 1.875 = V_{PR}$ , 100% production tested, $t_m = 1$ sec, partial discharge < 5 pC	$V_{PR}$	1590	V peak
Input-to-Output Test Voltage, Method A		$V_{PR}$	1357	V peak
After Environmental Tests, Subgroup 1	$V_{IORM} \times 1.6 = V_{PR}$ , $t_m = 60$ sec, partial discharge < 5 pC			
After Input and/or Safety Test, Subgroup 2/Subgroup 3	$V_{IORM} \times 1.2 = V_{PR}$ , $t_m = 60$ sec, partial discharge < 5 pC		1018	V peak
Highest Allowable Overvoltage		$V_{TR}$	6000	V peak
<b>SAFETY-LIMITING VALUES</b>				
Case Temperature		$T_S$	150	°C
Input Current		$I_{S, INPUT}$	265	mA
Output Current		$I_{S, OUTPUT}$	335	mA
Insulation Resistance at $T_S$		$R_S$	>10 <sup>9</sup>	Ω

## ABSOLUTE MAXIMUM RATINGS

$T_A = 25^\circ\text{C}$ , unless otherwise noted. All voltages are relative to their respective ground.

Table 6.

Parameter	Rating
$V_{DD1}$	-0.5 V to +6 V
$V_+$	-36 V to +36 V
$V_{+R}$	-36 V to +36 V
Digital Input Voltage	
TxD	-0.5 V to $V_{DD1} + 0.5$ V
Digital Output Voltage	
RxD	-0.5 V to $V_{DD1} + 0.5$ V
$V_{+SENSE}$	-0.5 V to $V_{DD1} + 0.5$ V
CANH, CANL	-36 V to +36 V
$V_{REF}$	-0.5 V to +6 V
Operating Temperature Range	-40°C to +85°C
Storage Temperature Range	-55°C to +150°C
ESD (Human Body Model)	3 kV
Lead Temperature	
Soldering (10 sec)	300°C
Vapor Phase (60 sec)	215°C
Infrared (15 sec)	220°C
$\theta_{JA}$ , Thermal Impedance	53°C/W
$T_J$ , Junction Temperature	130°C

Stresses at or above those listed under Absolute Maximum Ratings may cause permanent damage to the product. This is a stress rating only; functional operation of the product at these or any other conditions above those indicated in the operational section of this specification is not implied. Operation beyond the maximum operating conditions for extended periods may affect product reliability.

Table 7. Maximum Continuous Working Voltage<sup>1</sup>

Parameter	Max	Unit	Reference Standard
AC Voltage			
Bipolar Waveform			
Basic Insulation	565	V peak	50-year minimum lifetime
Reinforced Insulation	565	V peak	50-year minimum lifetime
Unipolar Waveform			
Basic Insulation	1131	V peak	50-year minimum lifetime
Reinforced Insulation	864	V peak	Lifetime limited by package creepage
DC Voltage			
Basic Insulation	1066	V peak	Lifetime limited by package creepage
Reinforced Insulation	529	V peak	Lifetime limited by package creepage

<sup>1</sup> Refers to continuous voltage magnitude imposed across the isolation barrier.

### ESD CAUTION



**ESD (electrostatic discharge) sensitive device.** Charged devices and circuit boards can discharge without detection. Although this product features patented or proprietary protection circuitry, damage may occur on devices subjected to high energy ESD. Therefore, proper ESD precautions should be taken to avoid performance degradation or loss of functionality.

## PIN CONFIGURATION AND FUNCTION DESCRIPTIONS

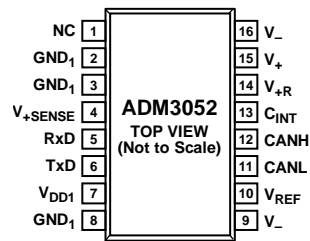

NOTES  
1. NC = NO CONNECT. DO NOT CONNECT TO THIS PIN.

09292-506

Figure 2. Pin Configuration

Table 8. Pin Function Descriptions

Pin No.	Mnemonic	Description
1	NC	No Connect. Do not connect to this pin.
2	GND <sub>1</sub>	Ground (Logic Side).
3	GND <sub>1</sub>	Ground (Logic Side).
4	V <sub>+SENSE</sub>	Bus Voltage Sense. A low level on V <sub>+SENSE</sub> indicates that there is power connected on the bus on V <sub>+</sub> and V <sub>-</sub> . A high level on V <sub>+SENSE</sub> indicates that power is not connected on the bus on V <sub>+</sub> and V <sub>-</sub> .
5	RxD	Receiver Output Data.
6	TxD	Driver Input Data.
7	V <sub>DD1</sub>	Power Supply (Logic Side). Decoupling capacitor to GND <sub>1</sub> required; capacitor value should be between 0.01 $\mu$ F and 0.1 $\mu$ F.
8	GND <sub>1</sub>	Ground (Logic Side).
9	V <sub>-</sub>	Ground (Bus Side).
10	V <sub>REF</sub>	Reference Voltage Output.
11	CANL	Low Level CAN Voltage Input/Output.
12	CANH	High Level CAN Voltage Input/Output.
13	C <sub>INT</sub>	A capacitor of 1 $\mu$ F, 10 V is required on this pin.
14	V <sub>+R</sub>	Connect a 300 $\Omega$ , 750 mW resistor between V <sub>+R</sub> and V <sub>+</sub> . It is recommended that a 10 $\mu$ F capacitor be fitted between V <sub>+R</sub> and GND <sub>2</sub> .
15	V <sub>+</sub>	Bus Power Connection. Connect a 300 $\Omega$ , 750 mW resistor between V <sub>+R</sub> and V <sub>+</sub> .
16	V <sub>-</sub>	Ground (Bus Side).

TYPICAL PERFORMANCE CHARACTERISTICS

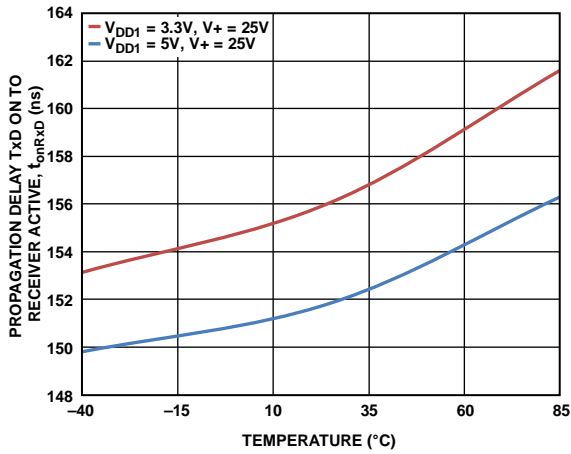

Figure 3. Propagation Delay from TxD On to Receiver Active vs. Temperature

09292-023

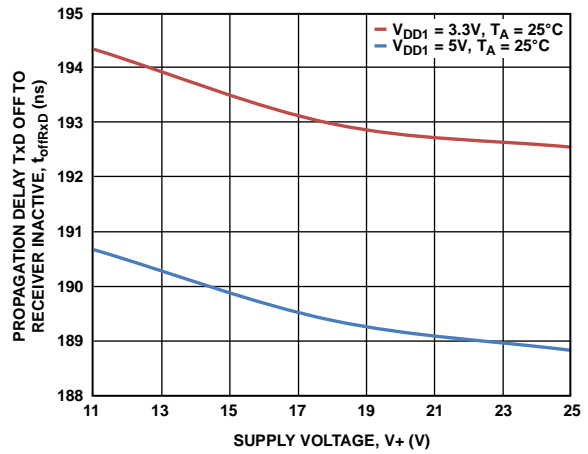

Figure 6. Propagation Delay from TxD Off to Receiver Inactive vs. Supply Voltage, V+

09292-026

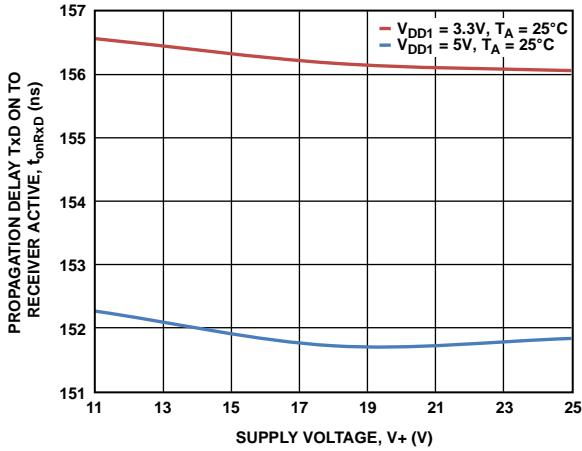

Figure 4. Propagation Delay from TxD On to Receiver Active vs. Supply Voltage, V+

09292-024

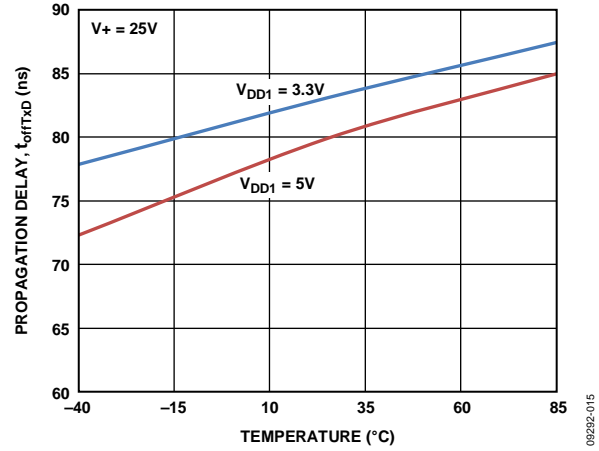

Figure 7. Propagation Delay from TxD Off to Bus Inactive vs. Temperature

09292-015

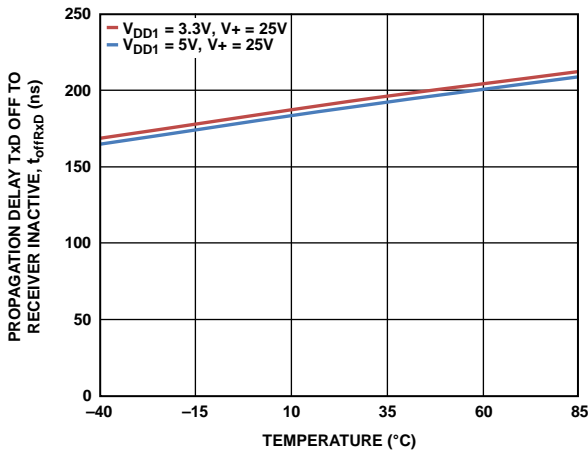

Figure 5. Propagation Delay from TxD Off to Receiver Inactive vs. Temperature

09292-025

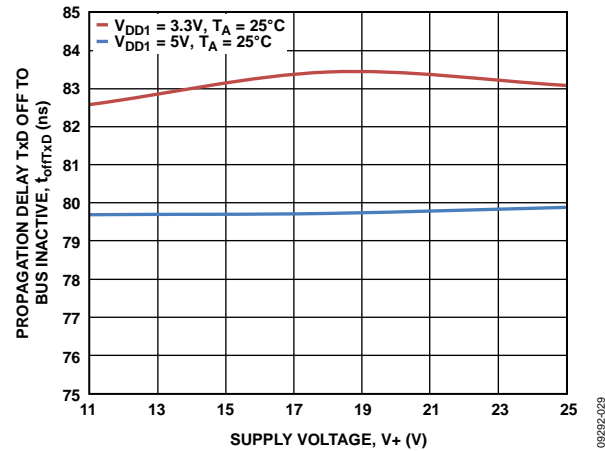

Figure 8. Propagation Delay from TxD Off to Bus Inactive vs. Supply Voltage, V+

09292-029



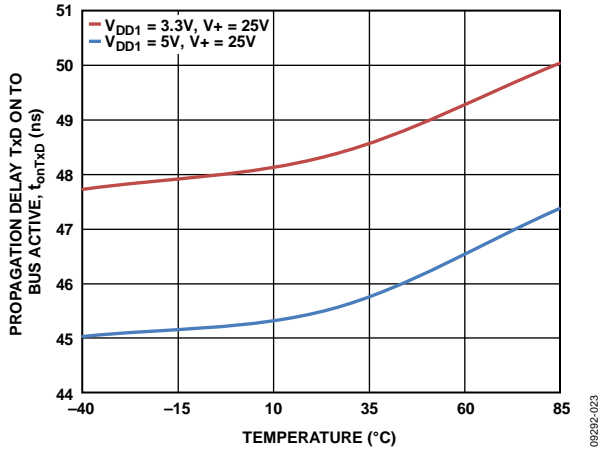

Figure 9. Propagation Delay from TxD On to Bus Active vs. Temperature

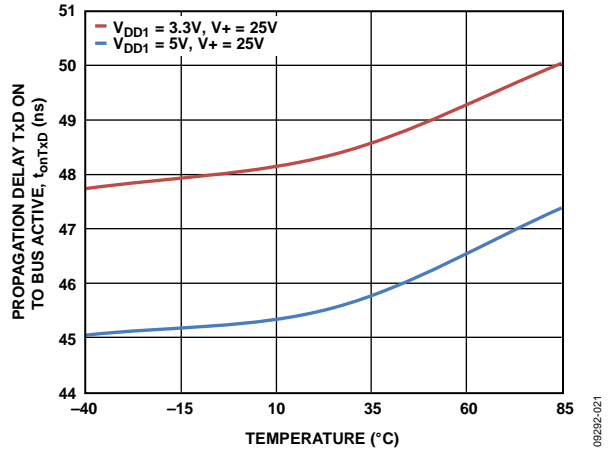

Figure 12. Propagation Delay from TxD On to Bus Active vs. Temperature

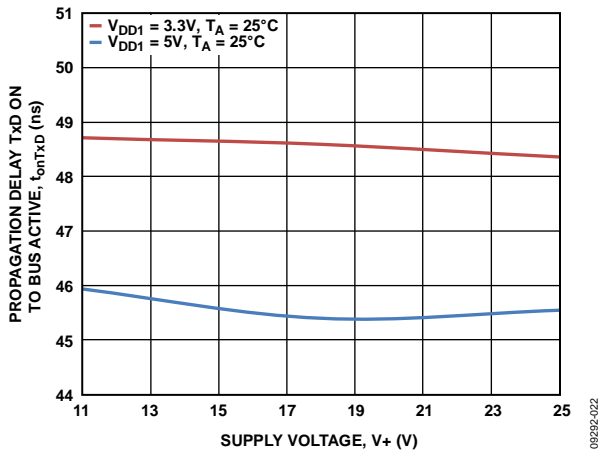

Figure 10. Propagation Delay from TxD On to Bus Active vs. Supply Voltage,  $V_+$

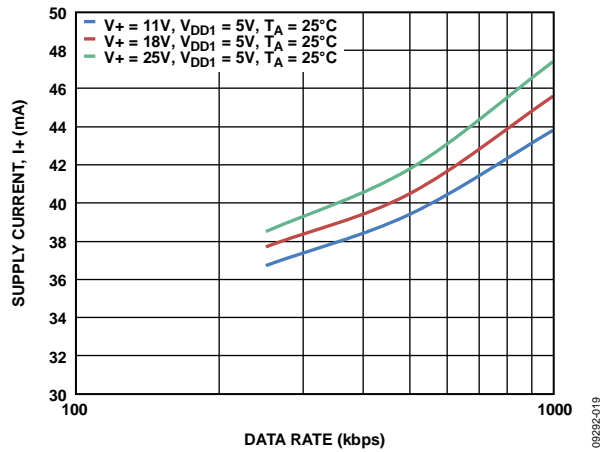

Figure 13. Supply Current ( $I_+$ ) vs. Data Rate (Across  $V_+$ ,  $V_{DD1} = 5V$ )

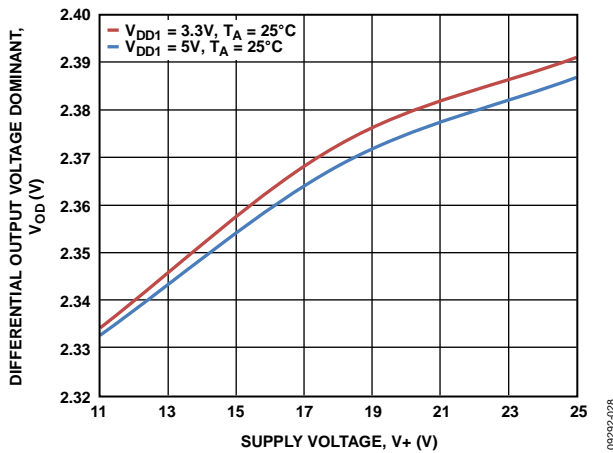

Figure 11. Differential Output Voltage Dominant vs. Supply Voltage,  $V_+$

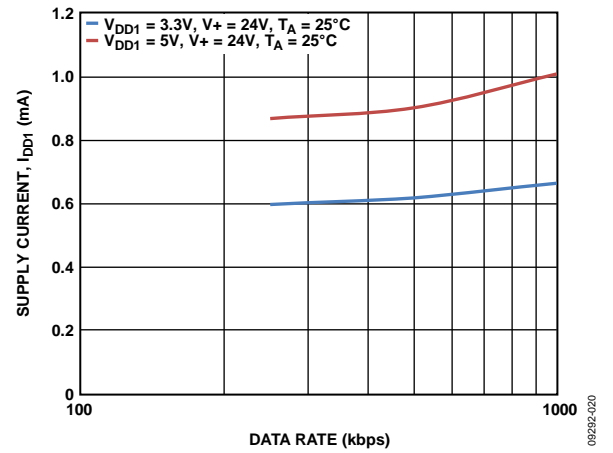

Figure 14. Supply Current ( $I_{DD1}$ ) vs. Data Rate ( $V_{DD1} = 3.3V, 5V$ ;  $V_+ = 24V$ )

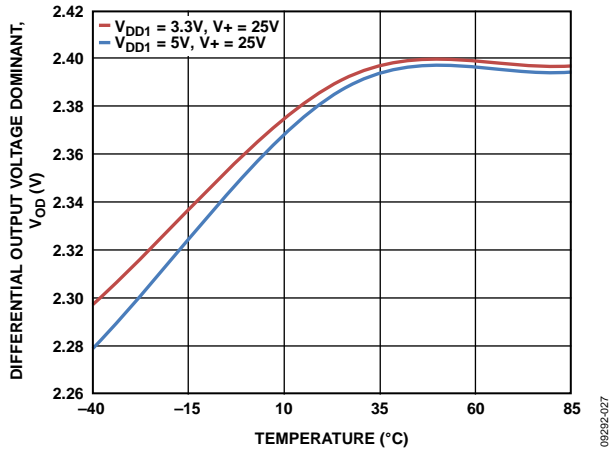

Figure 15. Driver Differential Output Voltage Dominant vs. Temperature

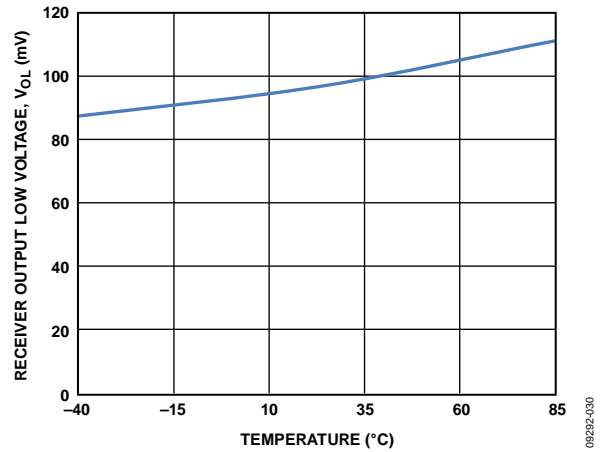

Figure 18. Receiver Output Low Voltage vs. Temperature

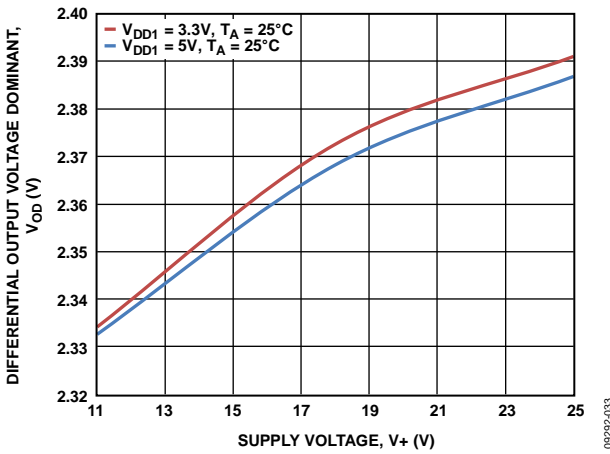

Figure 16. Driver Differential Output Voltage Dominant vs. Supply Voltage,  $V_+$

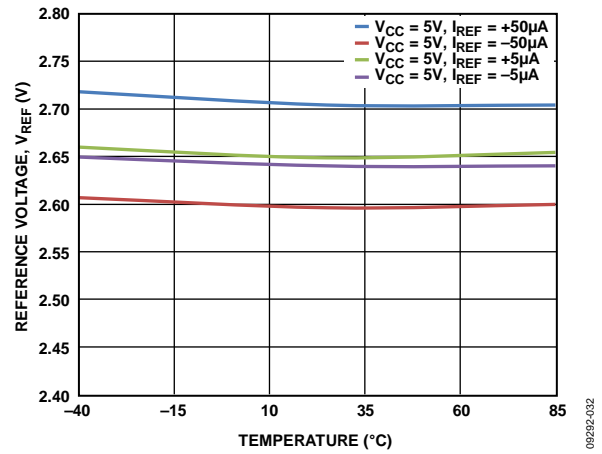

Figure 19.  $V_{REF}$  vs. Temperature

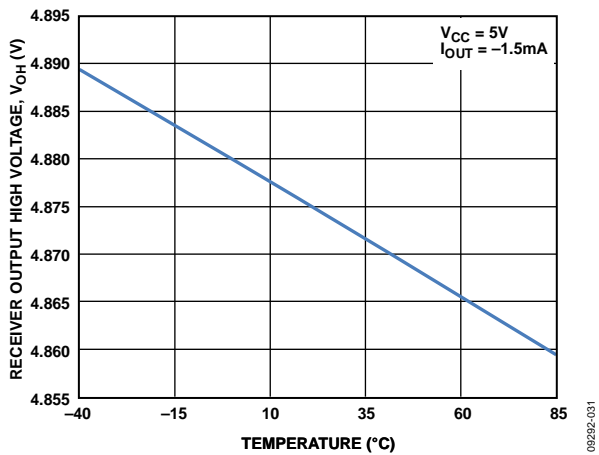

Figure 17. Receiver Output High Voltage vs. Temperature

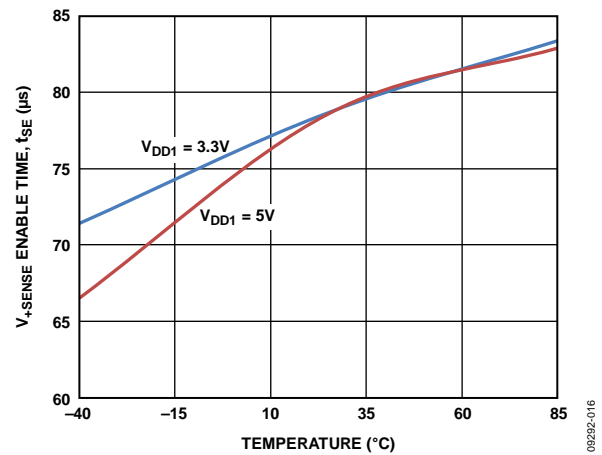

Figure 20. Enable Time,  $V_+$  High to  $V_{+SENSE}$  Low vs. Temperature

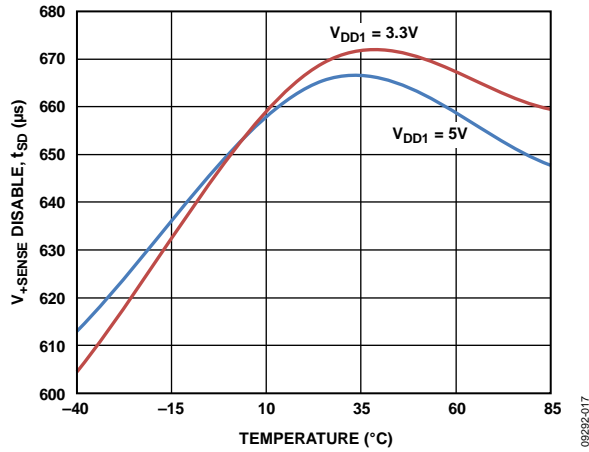

Figure 21. Disable Time,  $V_+$  Low to  $V_{+SENSE}$  High vs. Temperature

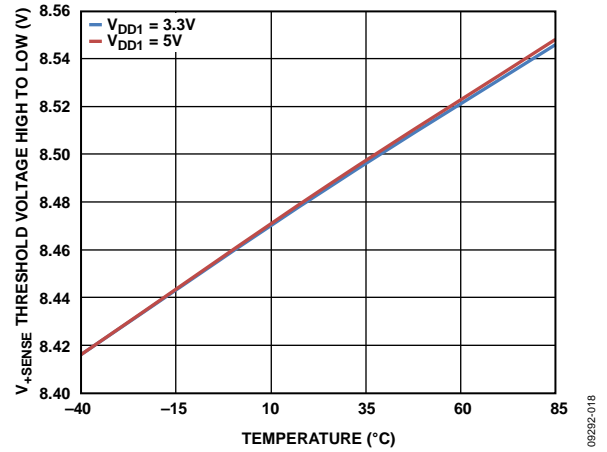

Figure 22. Bus Voltage Sense Threshold Voltage High to Low vs. Temperature

TEST CIRCUITS

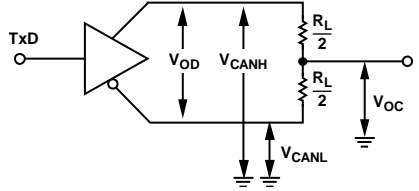

Figure 23. Driver Voltage Measurements

09292-007

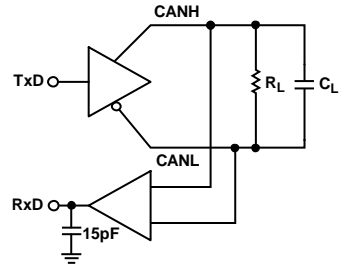

Figure 25. Switching Characteristics Measurements

09292-009

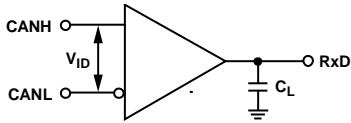

Figure 24. Receiver Voltage Measurements

09292-008

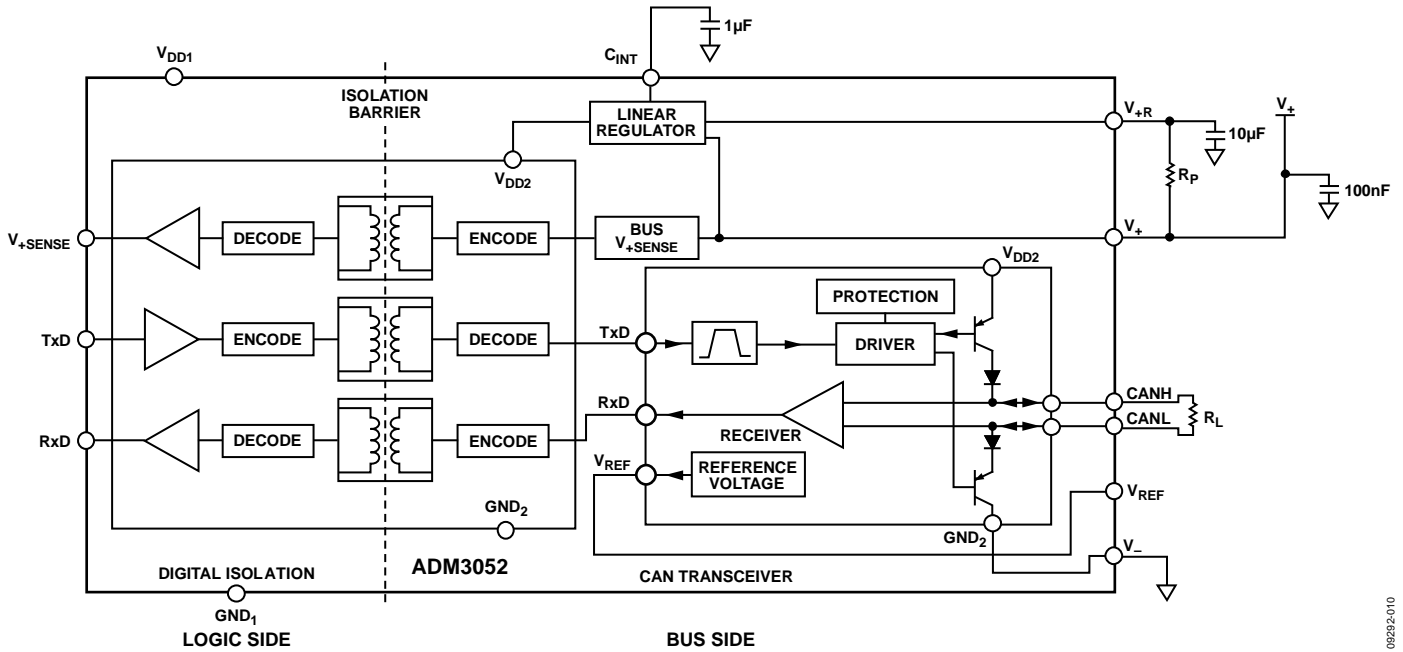

Figure 26. Supply Current Measurement Test Circuit

09292-010

# SWITCHING CHARACTERISTICS

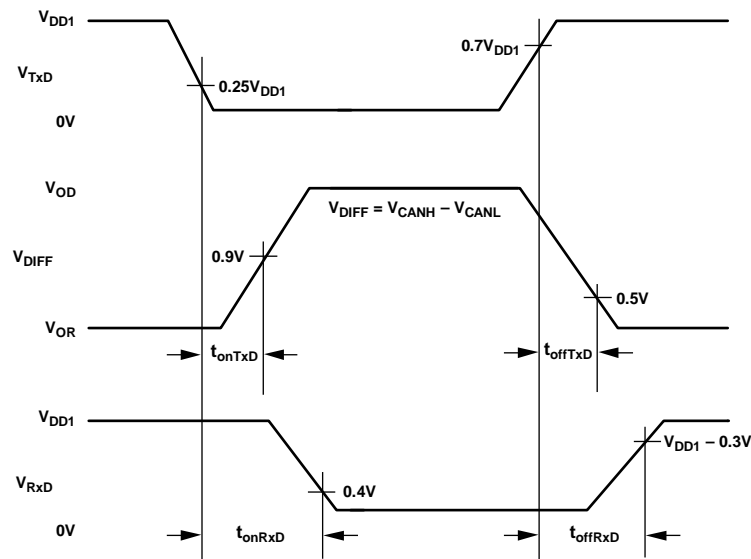

Figure 27. Driver and Receiver Propagation Delay

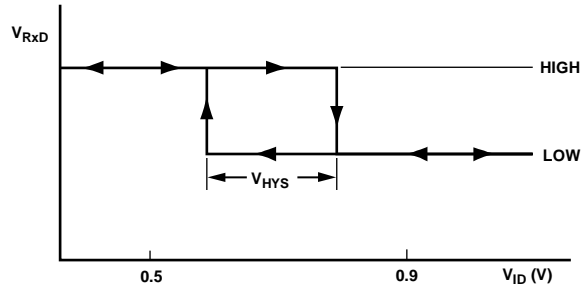

Figure 28. Receiver Input Hysteresis

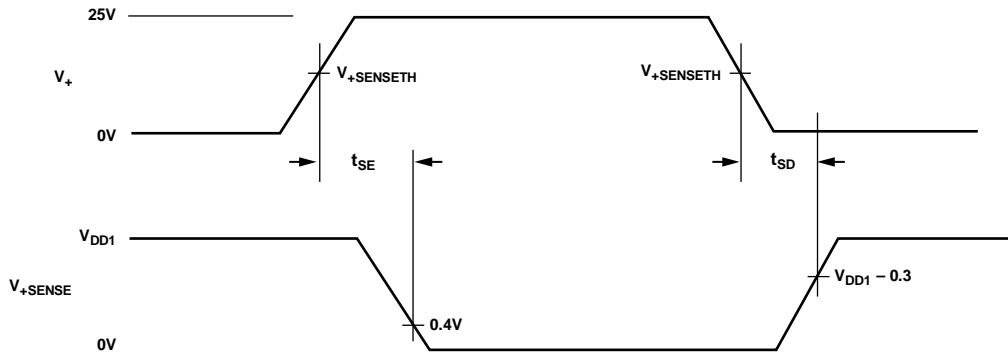

Figure 29.  $V_{+SENSE}$  Enable/Disable Time

## CIRCUIT DESCRIPTION

### CAN TRANSCEIVER OPERATION

A CAN bus has two states: dominant and recessive. A dominant state is present on the bus when the differential voltage between CANH and CANL is greater than 0.9 V. A recessive state is present on the bus when the differential voltage between CANH and CANL is less than 0.5 V. During a dominant bus state, the CANH pin is high and the CANL pin is low. During a recessive bus state, both the CANH and CANL pins are in the high impedance state.

### ELECTRICAL ISOLATION

In the ADM3052, electrical isolation is implemented on the logic side of the interface. Therefore, the device has two main sections: a digital isolation section and a transceiver section (see Figure 30). The driver input signal, which is applied to the TxD pin and referenced to the logic ground (GND<sub>1</sub>), is coupled across an isolation barrier to appear at the transceiver section referenced to the isolated ground (V<sub>-</sub>). Similarly, the receiver input and V<sub>+</sub>, which are referenced to the isolated ground in the transceiver section, are coupled across the isolation barrier to appear at the RxD pin and V<sub>+SENSE</sub> referenced to the logic ground, respectively.

### iCoupler Technology

The digital signals transmit across the isolation barrier using iCoupler technology. This technique uses chip scale transformer windings to couple the digital signals magnetically from one side of the barrier to the other. Digital inputs are encoded into

waveforms that are capable of exciting the primary transformer winding. At the secondary winding, the induced waveforms are decoded into the binary value that was originally transmitted.

Positive and negative logic transitions at the input cause narrow (~1 ns) pulses to be sent to the decoder via the transformer. The decoder is bistable and is, therefore, set or reset by the pulses, indicating input logic transitions. In the absence of logic transitions at the input for more than ~1 μs, a periodic set of refresh pulses, indicative of the correct input state, is sent to ensure dc correctness at the output. If the decoder receives no internal pulses for more than about 5 μs, the input side is assumed to be unpowered or nonfunctional, in which case the output is forced to a default state (see Table 10 and Table 11).

### TRUTH TABLES

The truth tables in this section use the abbreviations shown in Table 9.

**Table 9. Truth Table Abbreviations**

Letter	Description
H	High level
L	Low level
I	Indeterminate
X	Don't care
Z	High impedance (off)
NC	Disconnected

**Table 10. Transmitting**

Supply Status		Input	Outputs			
V <sub>DD1</sub>	V <sub>+</sub>	TxD	Bus State	CANH	CANL	V <sub>+SENSE</sub>
On	On	L	Dominant	H	L	L
On	On	H	Recessive	Z	Z	L
On	On	Floating	Recessive	Z	Z	L
Off	On	X	Recessive	Z	Z	I
On	Off	L	I	I	I	H

**Table 11. Receiving**

Supply Status		Inputs		Outputs	
V <sub>DD1</sub>	V <sub>+</sub>	V <sub>ID</sub> = CANH – CANL	Bus State	RxD	V <sub>+SENSE</sub>
On	On	≥ 0.9 V	Dominant	L	L
On	On	≤ 0.5 V	Recessive	H	L
On	On	0.5 V < V <sub>ID</sub> < 0.9 V	I	I	L
On	On	Inputs open	Recessive	H	L
Off	On	X	X	I	I
On	Off	X	X	H	H

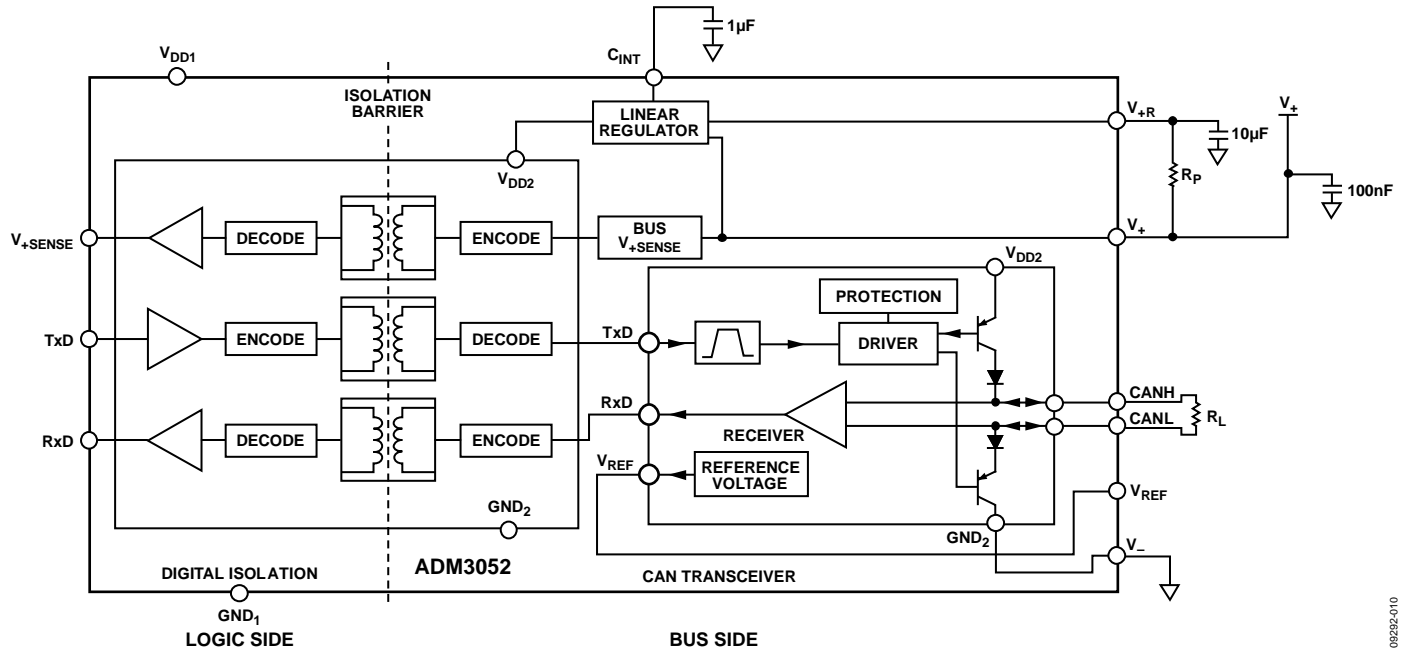

Figure 30. Digital Isolation and Transceiver Sections

08292-010

**THERMAL SHUTDOWN**

The ADM3052 contains thermal shutdown circuitry that protects the device from excessive power dissipation during fault conditions. Shorting the driver outputs to a low impedance source can result in high driver currents. The thermal sensing circuitry detects the increase in die temperature under this condition and disables the driver outputs. This circuitry is designed to disable the driver outputs when a junction temperature of 150°C is reached. As the device cools, the drivers reenable at a temperature of 140°C.

**LINEAR REGULATOR**

The linear regulator takes the V+ bus power (ranging between 11 V to 25 V) and regulates this voltage to 5 V to provide power to the internal bus-side circuitry (iCoupler isolation, V+SENSE, and transceiver circuits). The linear regulator uses two regulation loops to share the power dissipation between the internal die and an external resistor. This reduces the internal heat dissipation in the package. The 300 Ω external resistor should be capable of dissipating 750 mW of power and have a tolerance of 1%.

**MAGNETIC FIELD IMMUNITY**

The limitation on the magnetic field immunity of the iCoupler is set by the condition in which an induced voltage in the receiving coil of the transformer is large enough to either falsely set or reset the decoder. The following analysis defines the conditions under which this may occur. The 3 V operating condition of the ADM3052 is examined because it represents the most susceptible mode of operation.

The pulses at the transformer output have an amplitude greater than 1 V. The decoder has a sensing threshold of about 0.5 V, thus establishing a 0.5 V margin in which induced voltages can be tolerated.

The voltage induced across the receiving coil is given by

$$V = \left( \frac{-d\beta}{dt} \right) \sum \pi r_n^2 ; n = 1, 2, \dots, N$$

where:

β is the magnetic flux density (gauss).

N is the number of turns in the receiving coil.

r<sub>n</sub> is the radius of the n<sup>th</sup> turn in the receiving coil (cm).

Given the geometry of the receiving coil and an imposed requirement that the induced voltage is, at most, 50% of the 0.5 V margin at the decoder, a maximum allowable magnetic field can be determined using Figure 31.

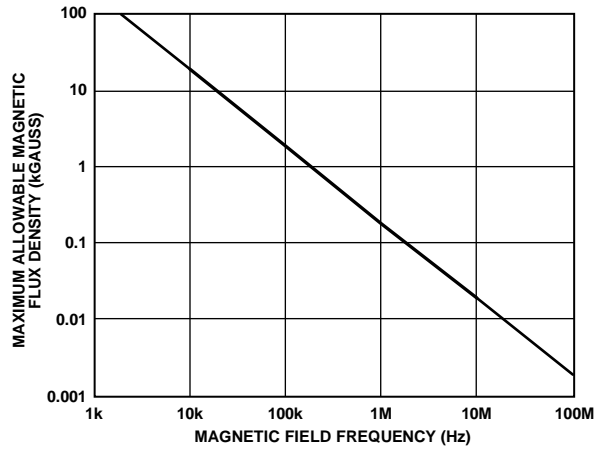

Figure 31. Maximum Allowable External Magnetic Flux Density

For example, at a magnetic field frequency of 1 MHz, the maximum allowable magnetic field of 0.2 kgauss induces a voltage of 0.25 V at the receiving coil. This is about 50% of the sensing threshold and does not cause a faulty output transition. Similarly, if such an event occurs during a transmitted pulse and is the worst-case polarity, it reduces the received pulse from >1.0 V to 0.75 V, still well above the 0.5 V sensing threshold of the decoder.

Figure 32 shows the magnetic flux density values in terms of more familiar quantities, such as maximum allowable current flow at given distances away from the ADM3052 transformers.

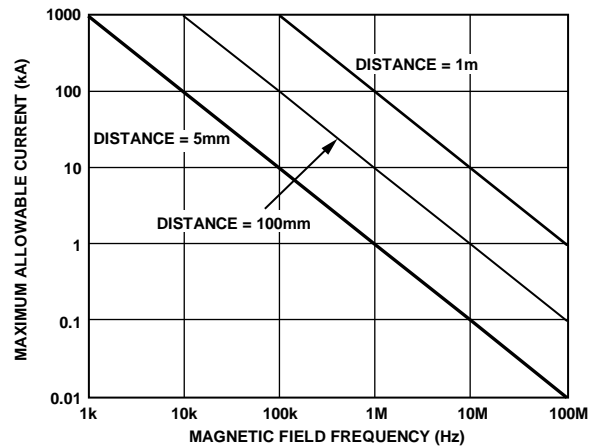

Figure 32. Maximum Allowable Current for Various Current-to-ADM3052 Spacings

With combinations of strong magnetic field and high frequency, any loops formed by PCB traces can induce error voltages large enough to trigger the thresholds of succeeding circuitry. Care should be taken in the layout of such traces to avoid this possibility.





OUTLINE DIMENSIONS

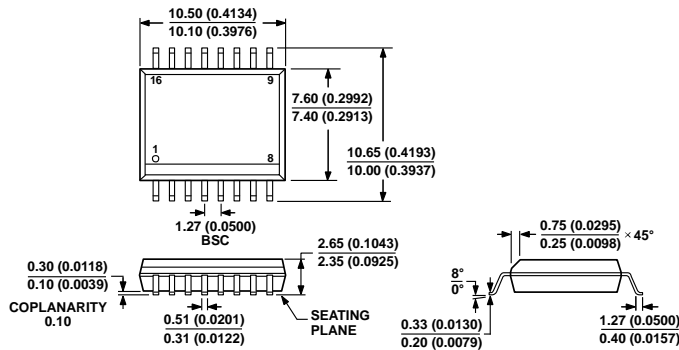

COMPLIANT TO JEDEC STANDARDS MS-013-AA  
 CONTROLLING DIMENSIONS ARE IN MILLIMETERS; INCH DIMENSIONS  
 (IN PARENTHESES) ARE ROUNDED-OFF MILLIMETER EQUIVALENTS FOR  
 REFERENCE ONLY AND ARE NOT APPROPRIATE FOR USE IN DESIGN.

Figure 34. 16-Lead Standard Small Outline Package [SOIC\_W]  
 Wide Body  
 (RW-16)

Dimensions shown in millimeters and (inches)

00-27-28078

ORDERING GUIDE

Model <sup>1</sup>	Temperature Range	Package Description	Package Option
ADM3052BRWZ	-40°C to +85°C	16-Lead SOIC_W	RW-16
ADM3052BRWZ-REEL7	-40°C to +85°C	16-Lead SOIC_W	RW-16
EVAL-ADM3052EBZ		Evaluation Board	

<sup>1</sup> Z = RoHS Compliant Part.

**NOTES**

**NOTES**