

Automotive IPD series

1ch High-side Switch IC

BV1HD090FJ-C

Features

- AEC-Q100 qualified (Note 1)
- Built-in overcurrent limiting circuit (OCP)
- Built-in thermal shutdown circuit (TSD)
- Built-in open load detection function (at output OFF)
- Direct control enabled from CMOS logic IC, etc.
- Built-in under voltage lockout function
- Built-in Output State Pin
- On-Resistance $R_{ON}=90m\Omega$ (Typ)
($V_{BB}=14V$, $T_j=25^\circ C$, $I_{OUT}=0.5A$)
- Monolithic power management IC with the control block (CMOS) and power MOS FET mounted on a single chip
- Enables operation at low voltage down to 4.2V
(Note 1:Grade1)

Product Summary

Wide Operating Input Range	4.5V to 36V
On-state Resistance ($T_j=25^\circ C$, Typ)	90m Ω
Overcurrent limit ($T_j=25^\circ C$, Typ)	5.5A
Active Clamp Energy ($T_j=150^\circ C$)	68mJ

Package
SOP-J8

W(Typ) x D(Typ) x H(Max)
4.90mm x 6.00mm x 1.65mm



SOP-J8

General Description

BV1HD090FJ-C is an automotive 1ch high side switch IC, which has built-in overcurrent limiting circuit(OCP), thermal shutdown circuit(TSD), open load detection function (OLD) and under voltage lockout function (UVLO). It is also equipped with the diagnostic output when detecting an error (ST).

Applications

- Onboard vehicle device (engine ECU, air conditioner, body-control etc)

Block Diagram

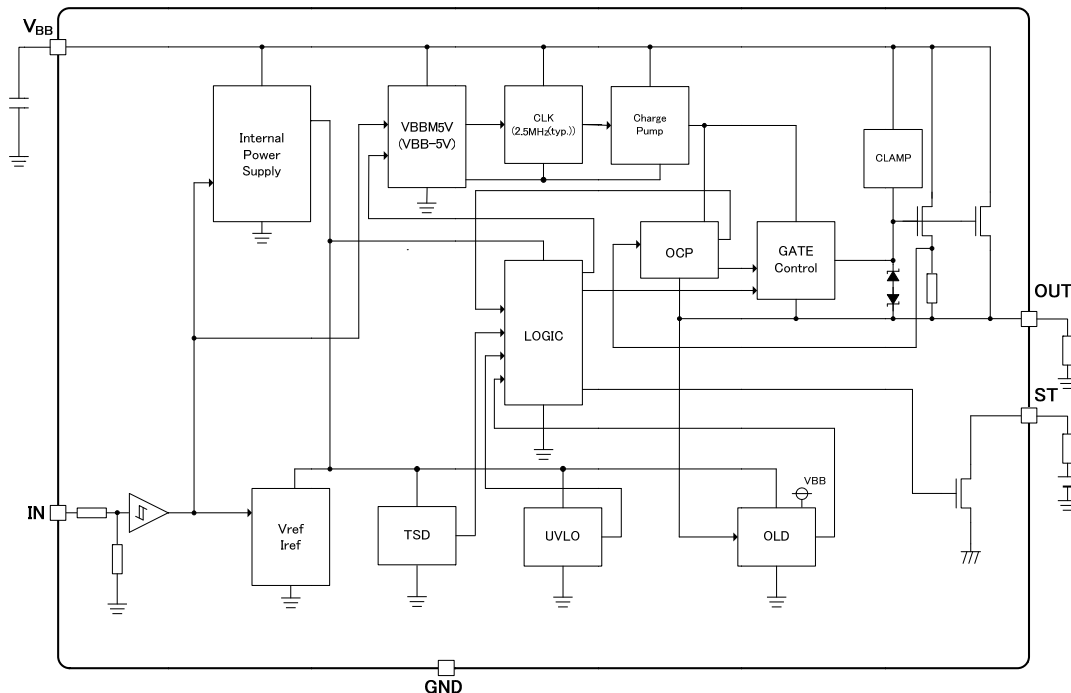

Figure 1. Block Diagram

○Product structure : Silicon monolithic integrated circuit ○This product has no designed protection against radioactive rays

Pin Configurations

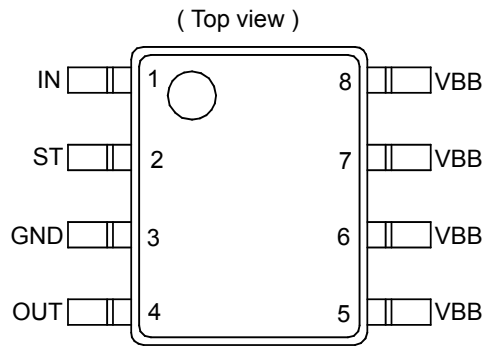

Figure 2. Pin Configurations

Pin Descriptions

Pin No.	Unit	Function
1	IN	Input pin. This input has a pull-down resistor.
2	ST	Self-diagnostic output terminal, which outputs “Low” at overcurrent or overtemperature, and “High” at open load. It has an n-channel open drain circuit structure.
3	GND	GND pin
4	OUT	Output terminal, which limits the output current to protect the IC when the load is short-circuited and current exceeding the overcurrent detection value (2.7A min) flows to the output terminal.
5, 6, 7, 8	VBB	Power Supply Voltage

Definition

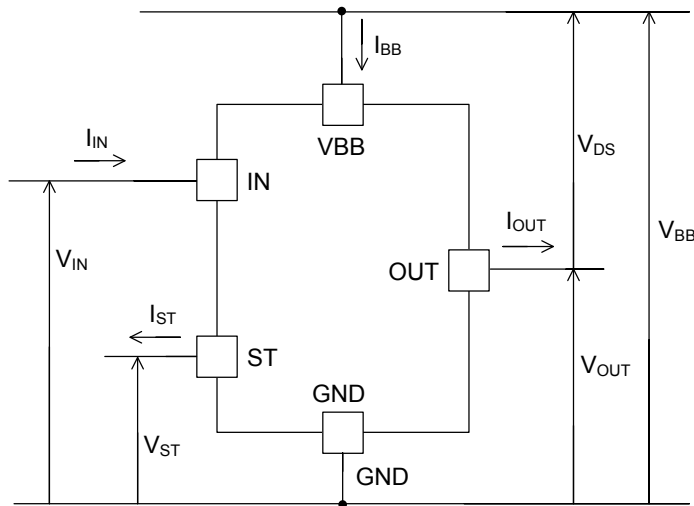

Figure 3. Voltage/Current Definition

Absolute Maximum Ratings (Tj = 25°C)

Parameter	Symbol	Rating	Unit
VBB-OUT Voltage	V _{DS}	45 (internal limit)	V
Power Supply Voltage	V _{BB}	40	V
Input Voltage	V _{IN}	-0.3 to +7.0	V
Diagnostic Output Voltage	V _{ST}	-0.3 to +7.0	V
Output Current	I _{OUT}	9.0(Internal limit I _{OC}) ^(Note 1)	A
Diagnostic Output Current	I _{ST}	10	mA
Junction Temperature Range	T _J	-40 to +150	°C
Storage Temperature Range	T _{stg}	-55 to +150	°C
Maximum Junction Temperature	T _{jmax}	+150	°C
Active Clamp Energy (single pulse) T _{j(start)} =25°C ^(Note 2)	E _{AS(25°C)}	242	mJ
Active Clamp Energy (single pulse) T _{j(start)} =150°C ^{(Note 2)(Note 3)}	E _{AS(150°C)}	68	mJ

(Note 1) Internally limited by the overcurrent limiting circuit. Value is a maximum.

(Note 2) Maximum Active clamp energy, using single non-repetitive pulse of I_{AR} = 1.5A and V_{BB} = 14V.

During demagnetization of inductive loads, energy must be dissipated in the BV1HD090FJ-C.

This energy can be calculated with following equation:

$$E_{AS} = V_{DS} \times \frac{L}{R_L} \times \left[\frac{V_{BB} - V_{DS}}{R_L} \times \ln \left(1 - \frac{R_L \times I_{AR}}{V_{BB} - V_{DS}} \right) + I_{AR} \right]$$

Following equation simplifies under the assumption of R_L=0Ω.

$$E_{AS} = \frac{1}{2} \times L \times I_{AR}^2 \times \left(1 - \frac{V_{BB}}{V_{DS}} \right)$$

(Note 3) This active clamp energy is guaranteed by design.

Recommended Operating Conditions (Tj= -40°C to +150°C)

Parameter	Symbol	Min	Typ	Max	Unit
Power Supply Voltage	V _{BB}	4.5	14	36	V

Thermal Resistance^(Note 1)

Parameter	Symbol	Typ	Unit	Condition
SOP-J8				
Between Junction and Surroundings Temperature Thermal Resistance	θ_{JA}	143.7	°C / W	1s ^(Note 2)
		86.9	°C / W	2s ^(Note 3)
		67.5	°C / W	2s2p ^(Note 4)

(Note 1) The thermal impedance is based on JESD51 - 2A (Still - Air) standard. It is used the chip of BV1HD090FJ-C

(Note 2) JESD51 - 3 standard FR4 114.3 mm × 76.2 mm × 1.57 mm 1-layer (1s)

(Top copper foil: ROHM recommended footprint + wiring to measure, 2 oz. copper.)

(Note 3) JESD51 -5 standard FR4 114.3 mm × 76.2 mm × 1.60 mm 2-layer (2s)

(Top copper foil: ROHM recommended footprint + wiring to measure /

Copper foil area on the reverse side of PCB: 74.2 mm x 74.2 mm, 2 oz. copper (top & reverse side))

(Note 4) JESD51 -5 / -7 standard FR4 114.3 mm × 76.2 mm × 1.60 mm 4-layer (2s2p)

(Top copper foil: ROHM recommended footprint + wiring to measure /

2 inner layers and copper foil area on the reverse side of PCB: 74.2 mm x 74.2 mm, copper (top & reverse side / inner layers) 2oz. / 1oz.)

■ PCB Layout 1 Layer (1s)

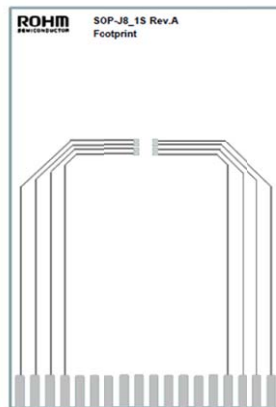

Footprint Only

Figure 4. PCB Layout 1 Layer (1s)

Dimension	Value
Board Finish Thickness	1.57 mm ± 10%
Board Dimension	76.2 mm x 114.3 mm
Board Material	FR4
Copper Thickness (Top/Bottom Layers)	0.070mm (Cu:2oz)

■ PCB Layout 2 Layers (2s)

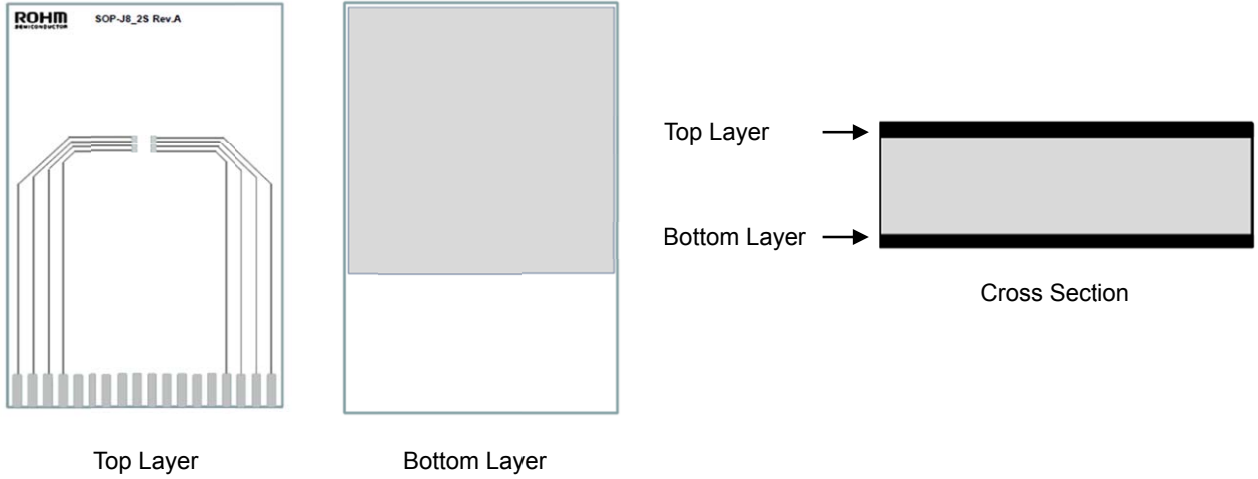

Figure 5. PCB Layout 2 Layers (2s)

Dimension	Value
Board Finish Thickness	1.60 mm ± 10%
Board Dimension	76.2 mm x 114.3 mm
Board Material	FR4
Copper Thickness (Top/Bottom Layers)	0.070mm (Cu + Plating)

■ PCB Layout 4 Layers(2s2p)

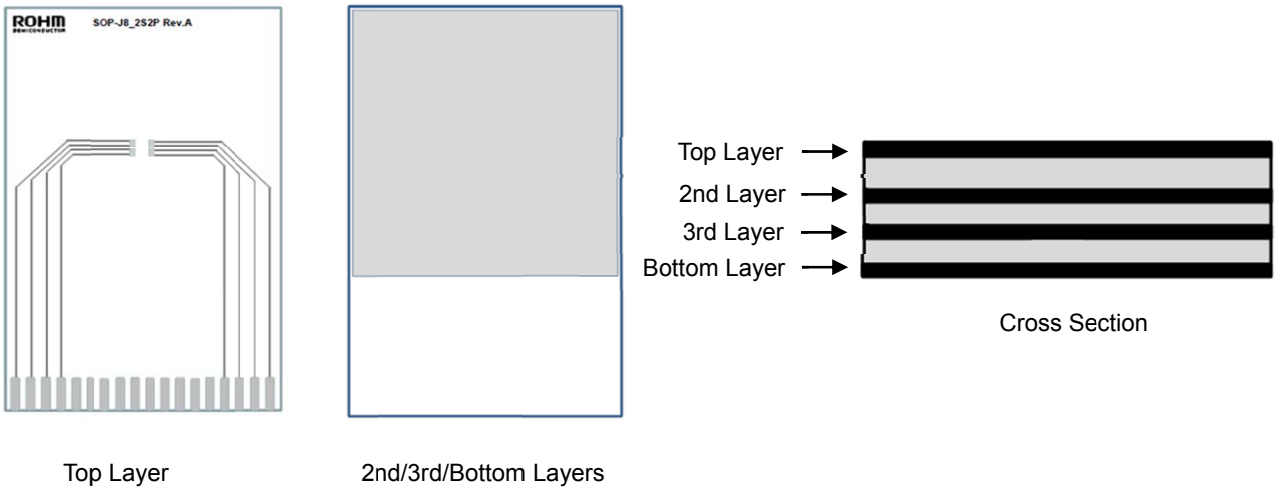

Figure 6. PCB Layout 4 Layers (2s2p)

Dimension	Value
Board Finish Thickness	1.60 mm ± 10%
Board Dimension	76.2 mm x 114.3 mm
Board Material	FR4
Copper Thickness (Top/Bottom Layers)	0.070mm (Cu + Plating)
Copper Thickness (Inner Layers)	0.035mm

■ Thermal Resistance (Single Pulse)

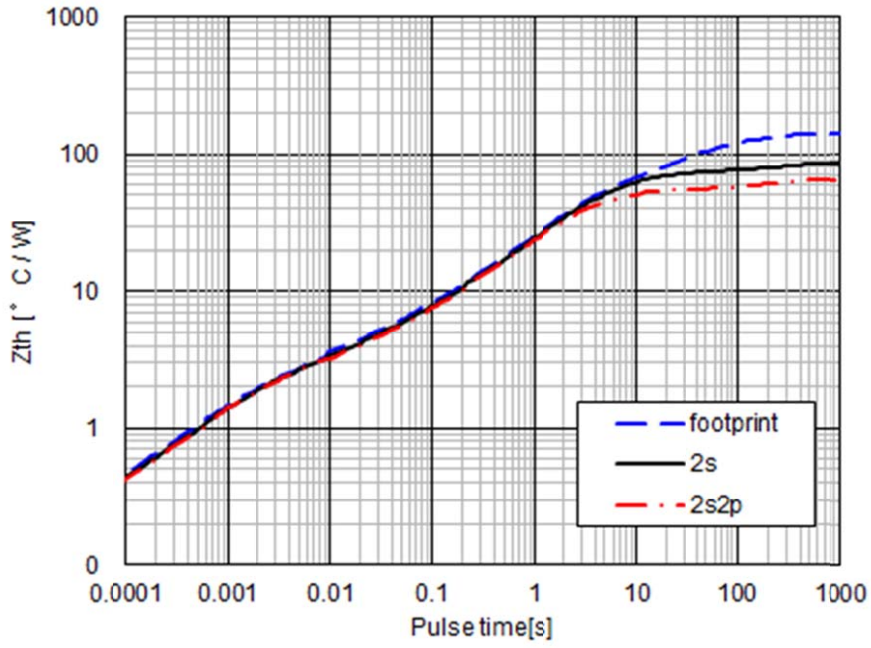

Figure 7. Thermal Resistance

Electrical Characteristics

(Unless otherwise specified Tj = -40 °C to +150 °C, V_{BB} = 4.5V to 36V)

Parameter	Symbol	Min	Typ	Max	Unit	Conditions
Power Supply						
Standby Current	I _{BBS1}	-	200	330	μA	V _{BB} =14V, V _{IN} =0V, V _{OUT} =0V, Tj=25°C
	I _{BBS2}	-	250	500	μA	V _{BB} =14V, V _{IN} =0V, V _{OUT} =0V, Tj=150°C
Bias Current	I _{BB}	-	3.0	6.0	mA	V _{BB} =14V, V _{IN} =5V, V _{OUT} =open
Under Voltage Lockout Threshold	V _{UVLO}	-	3.6	4.2	V	
Under Voltage Hysteresis Threshold	V _{UVHYS}	-	0.2	-	V	
Input						
High-Level Input Voltage	V _{INH}	2.8	-	-	V	
Low-Level Input Voltage	V _{INL}	-	-	1.5	V	
Input Hysteresis	V _{INHYS}	-	0.4	-	V	
High-Level Input Current	I _{INH}	-	50	150	μA	V _{IN} =5V
Low-Level Input Current	I _{INL}	-10	-	+10	μA	V _{IN} =0V
Power MOS						
On-State Resistance	R _{ON1}	-	90	120	mΩ	V _{BB} =8V to 36V, Tj=25°C
	R _{ON2}	-	160	215	mΩ	V _{BB} =8V to 36V, Tj=150°C
	R _{ON3}	-	-	500	mΩ	V _{BB} =4.2V
Leak Current	I _{OUTL1}	-	130	200	μA	V _{BB} =14V, V _{IN} =0V, V _{OUT} =0V, Tj=25°C
	I _{OUTL2}	-	160	250	μA	V _{BB} =14V, V _{IN} =0V, V _{OUT} =0V, Tj=150°C
	I _{OUTH3}	-160	-90	-	μA	V _{BB} =14V, V _{IN} =0V, V _{OUT} =V _{BB} , Tj=25°C
	I _{OUTH4}	-400	-110	-	μA	V _{BB} =14V, V _{IN} =0V, V _{OUT} =V _{BB} , Tj=150°C
Slew Rate	SR _{ON}	0.23	0.70	-	V/μs	V _{BB} =14V, R _L =10Ω, Tj=25°C
	SR _{OFF}	0.53	1.60	-	V/μs	V _{BB} =14V, R _L =10Ω, Tj=25°C
Propagation Delay at ON	t _{OUTON}	-	30	90	μs	V _{BB} =14V, R _L =10Ω, Tj=25°C
Propagation Delay at OFF	t _{OUTOFF}	-	20	60	μs	V _{BB} =14V, R _L =10Ω, Tj=25°C
Output Clamp Voltage	V _{DS}	45	50	56.5	V	V _{IN} =0V, I _{OUT} =-10mA
Output States						
ST ON Voltage	V _{STL}	-	-	0.3	V	V _{BB} =6V to 36V, V _{IN} =0V, I _{ST} =-0.6mA
ST Leak Current	I _{STH}	-10	-	-	μA	V _{IN} =5V, V _{ST} =5V
Diagnostic Output Delay Time at Input ON	t _{STON}	-	11	33	μs	V _{BB} =14V, R _L =10Ω, Tj=25°C
Diagnostic Output Delay Time at Input OFF	t _{STOFF}	-	30	90	μs	V _{BB} =14V, R _L =10Ω, Tj=25°C
Protection Circuit						
Overcurrent Detection Current	I _{OC}	2.7	5.5	9.0	A	
Overcurrent Detection OFF Time	t _{OCOFF}	-	550	1100	μs	
Overcurrent Detection ON Duty	D _{OC}	-	-	30	%	
Open Load Detection Resistance ^(Note1)	R _{OLD}	6	-	36	kΩ	V _{IN} =0V
Open Load Detection Voltage ^(Note1)	V _{OLD}	1.5	-	2.5	V	V _{IN} =0V
TSD Detection Temperature ^(Note2)	T _{TSD}	175	190	205	°C	
TSD Hysteresis ^(Note2)	T _{TSDHYS}	-	15	-	°C	

(Note1) The detectable power voltage range for open load is V_{BB} ≥ 6V.

(Note2) This temperature is guaranteed by design.

Typical Performance Curves

(Unless otherwise specified $V_{BB} = 14V$, $V_{IN} = 5V$, $T_j = 25^\circ C$)

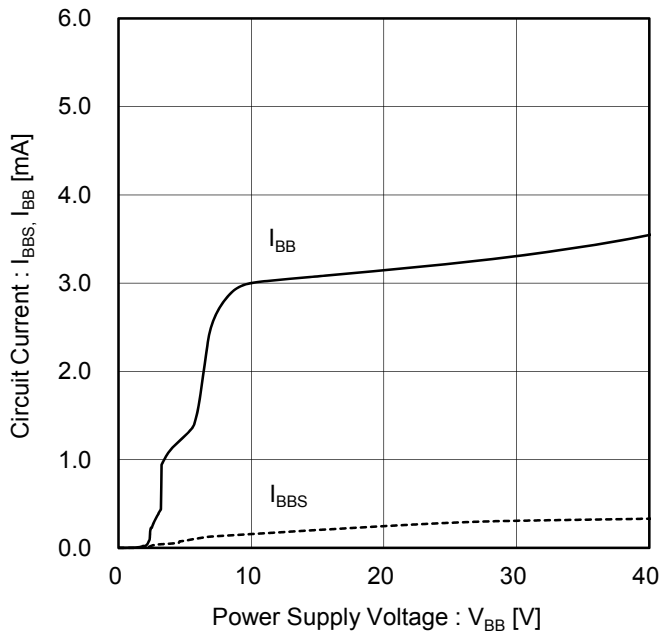

Figure 8. Circuit Current vs. Power Supply Voltage

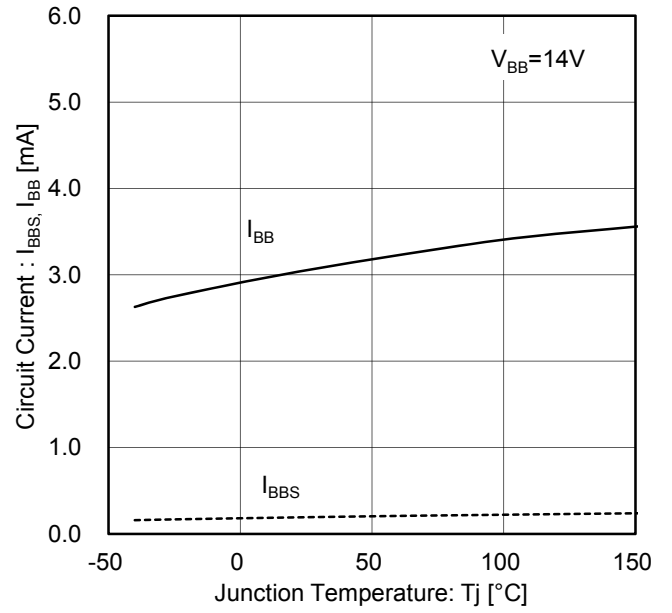

Figure 9. Circuit Current vs. Temperature

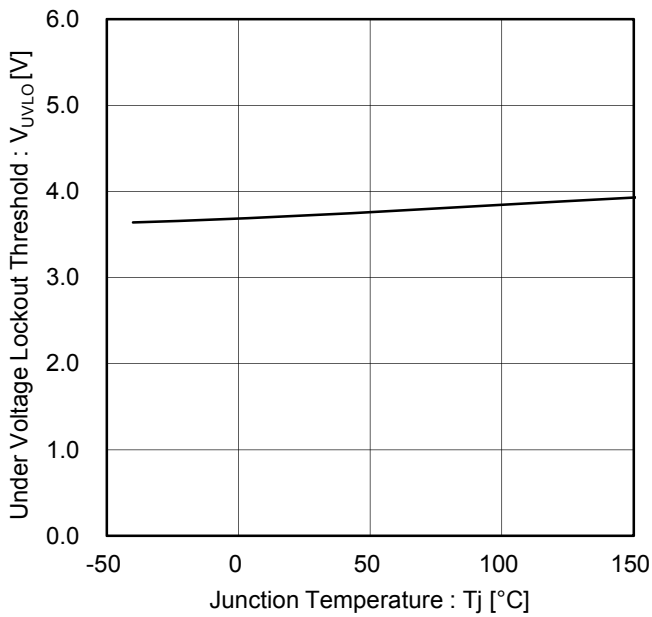

Figure 10. Under Voltage Lockout Threshold vs. Temperature

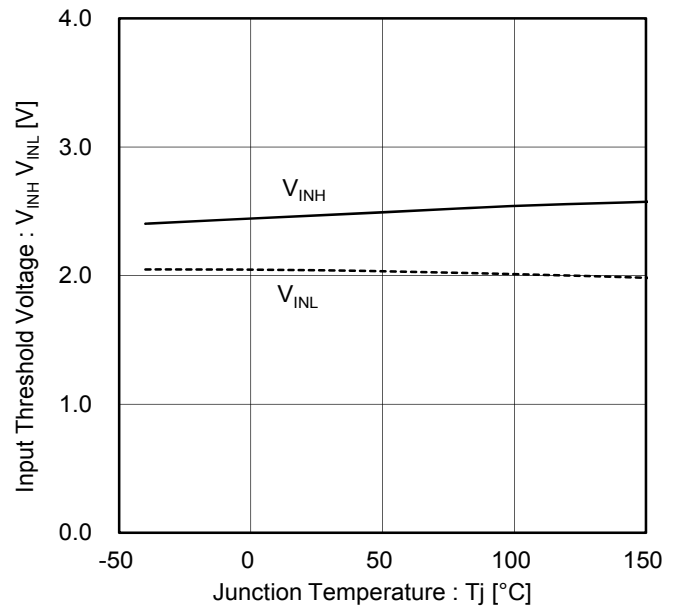

Figure 11. Input Threshold Voltage vs. Temperature

Typical Performance Curves - continued

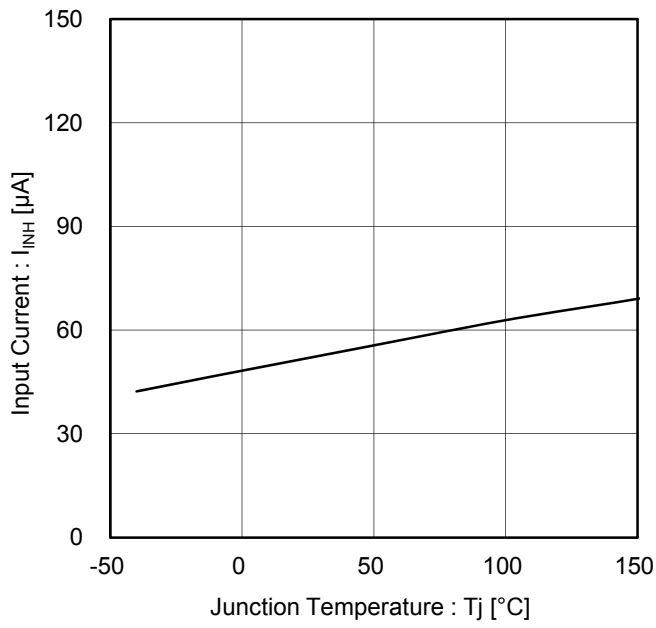

Figure 12. Input Current vs. Temperature

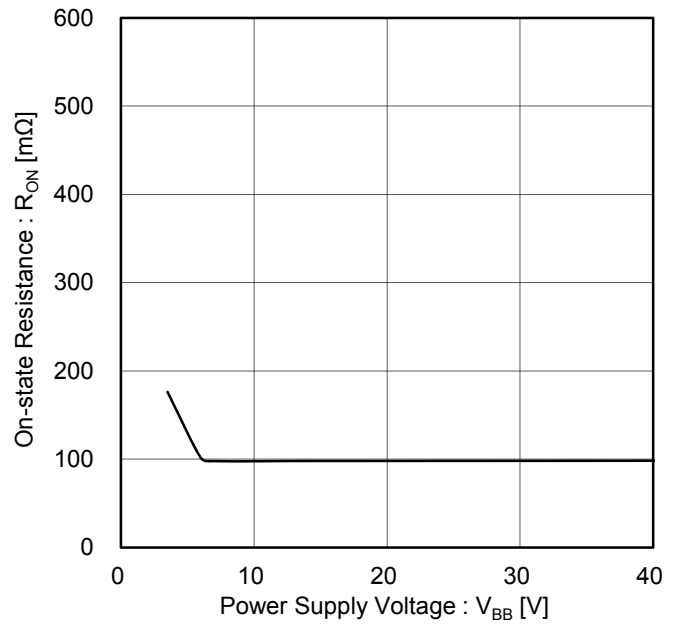

Figure 13. On-state Resistance vs. Power Supply Voltage

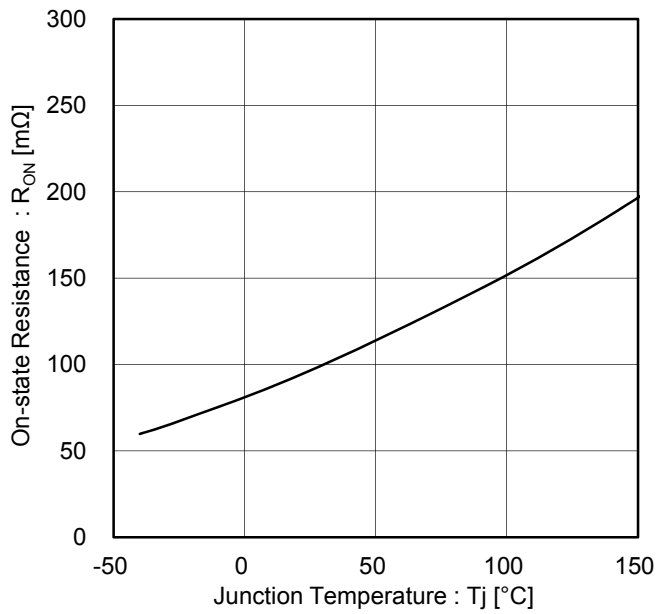

Figure 14. On-state Resistance vs. Temperature

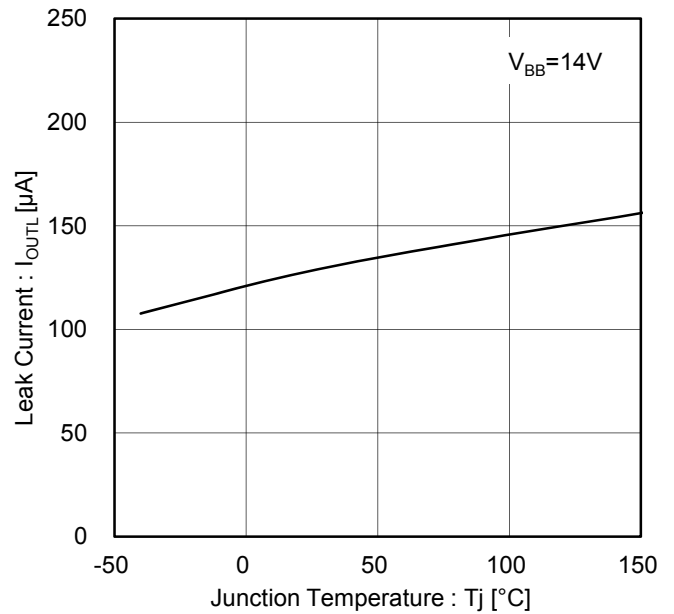

Figure 15. Leak Current vs. Temperature

Typical Performance Curves - continued

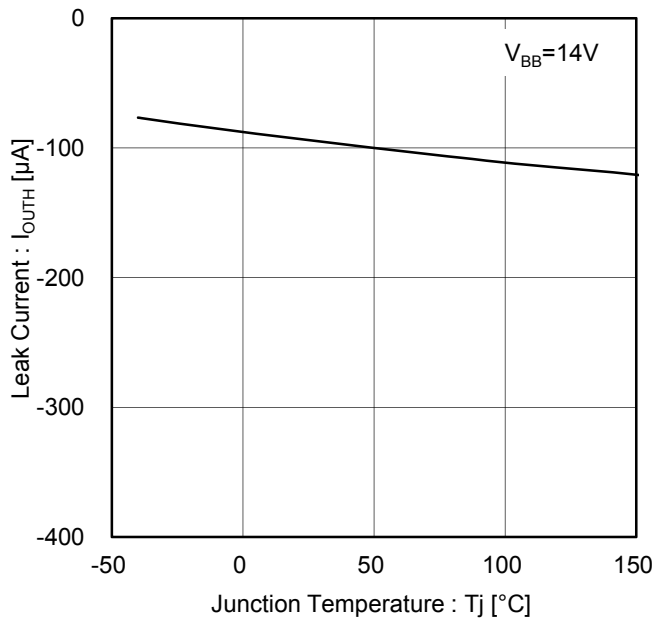

Figure 16. Leak Current vs. Temperature

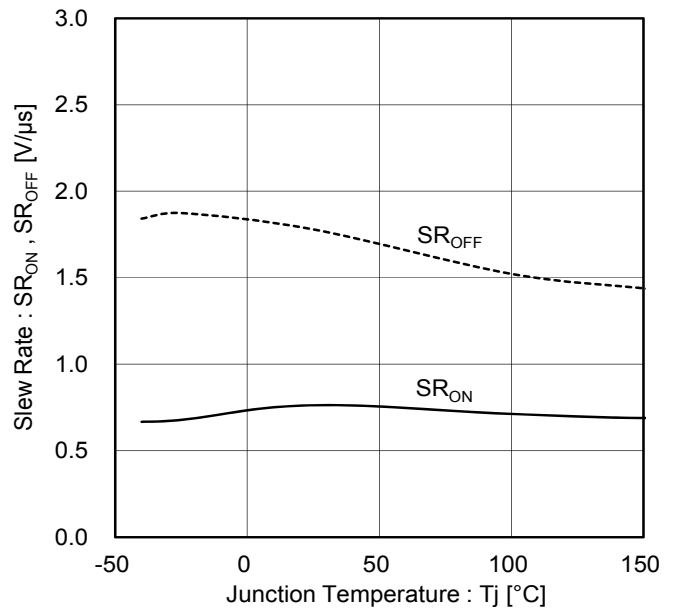

Figure 17. Slew Rate vs. Temperature

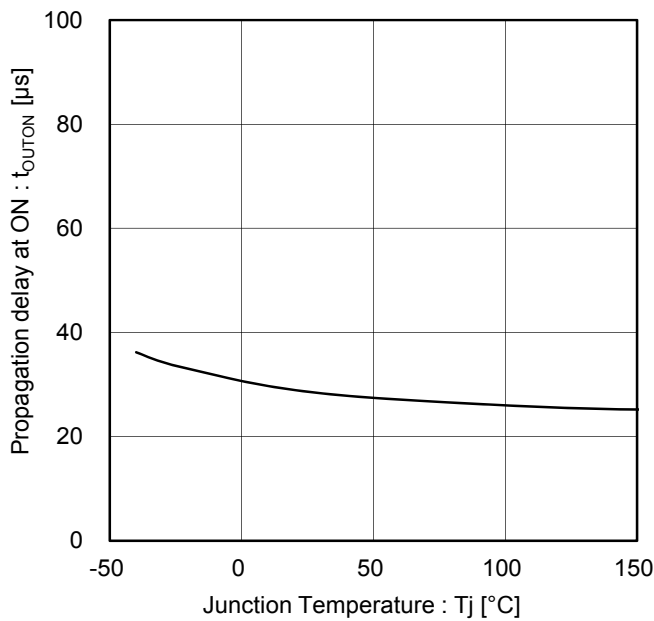

Figure 18. Propagation Delay at ON vs. Temperature

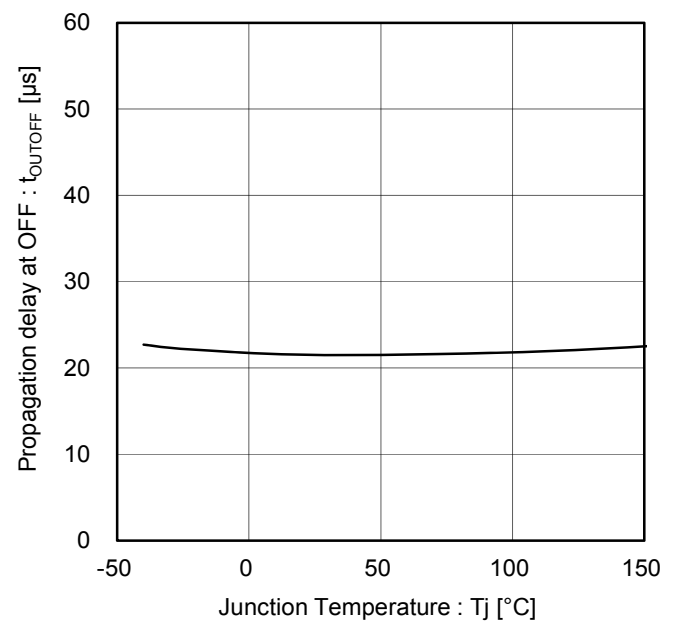

Figure 19. Propagation Delay at OFF vs. Temperature

Typical Performance Curves - continued

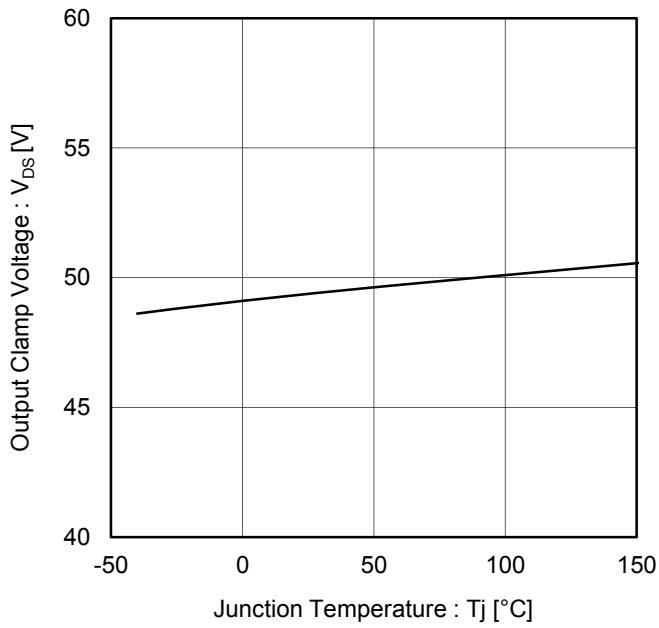

Figure 20. Output Clamp Voltage vs. Temperature

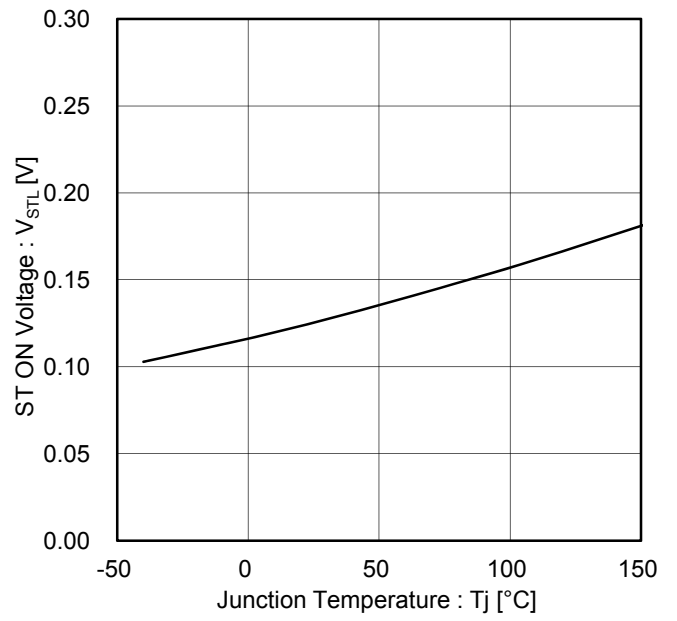

Figure 21. ST ON Voltage vs. Temperature

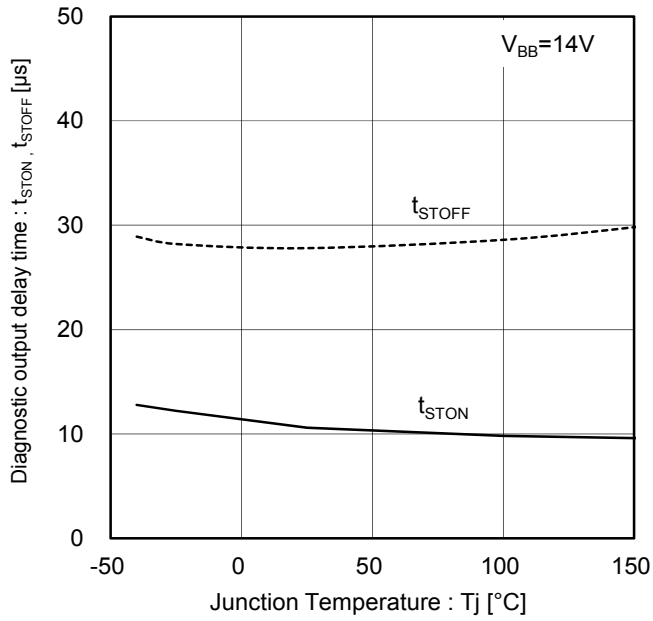

Figure 22. Diagnostic Output Delay Time vs. Temperature

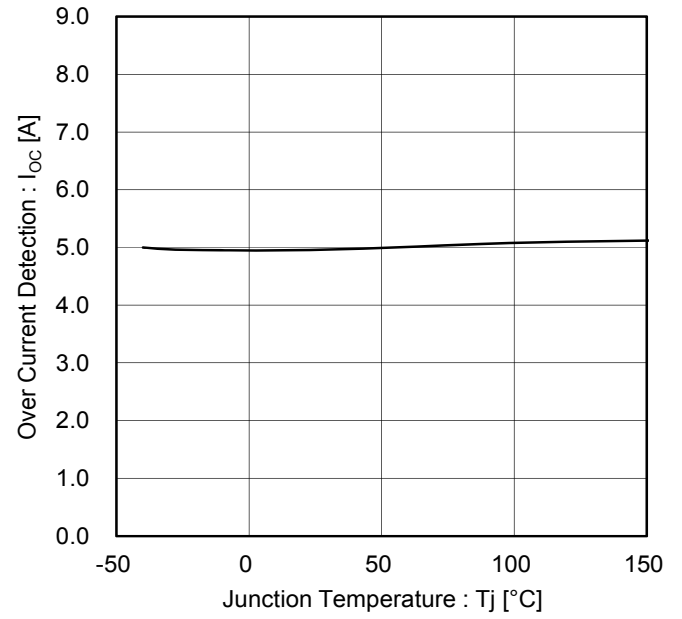

Figure 23. Overcurrent Detection vs. Temperature

Typical Performance Curves - continued

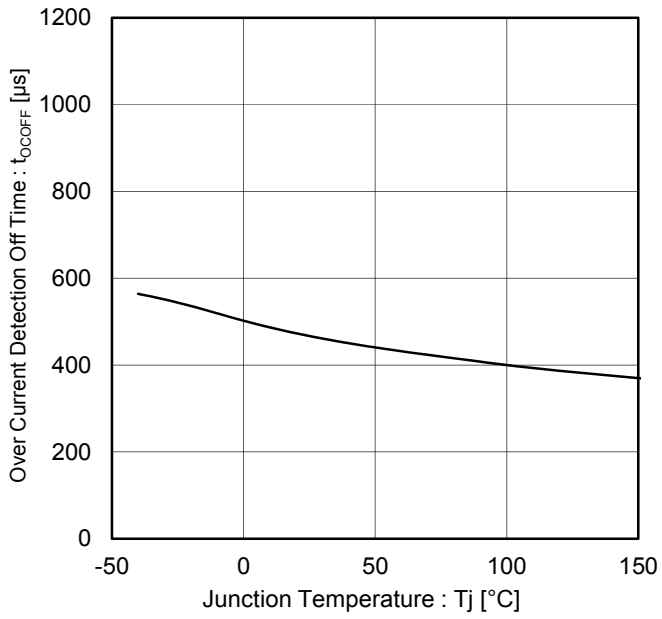

Figure 24. Overcurrent Detection Off Time vs. Temperature

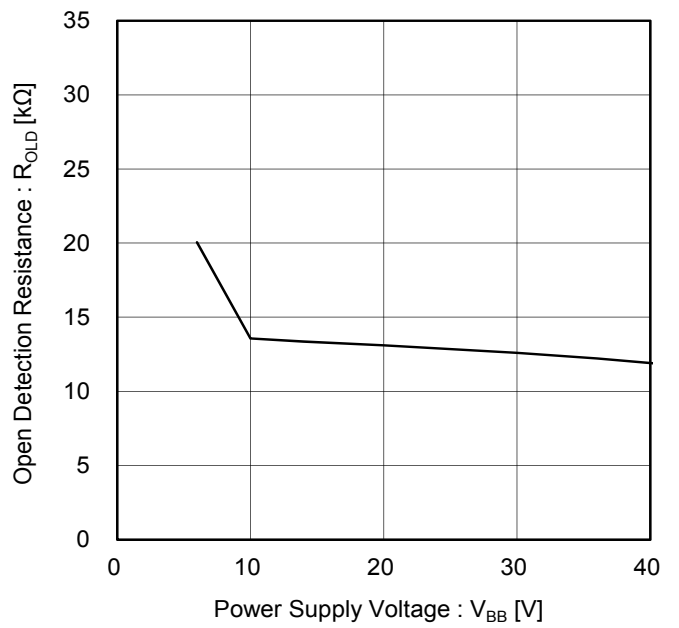

Figure 25. Open Detection Resistance vs. Power Supply Voltage

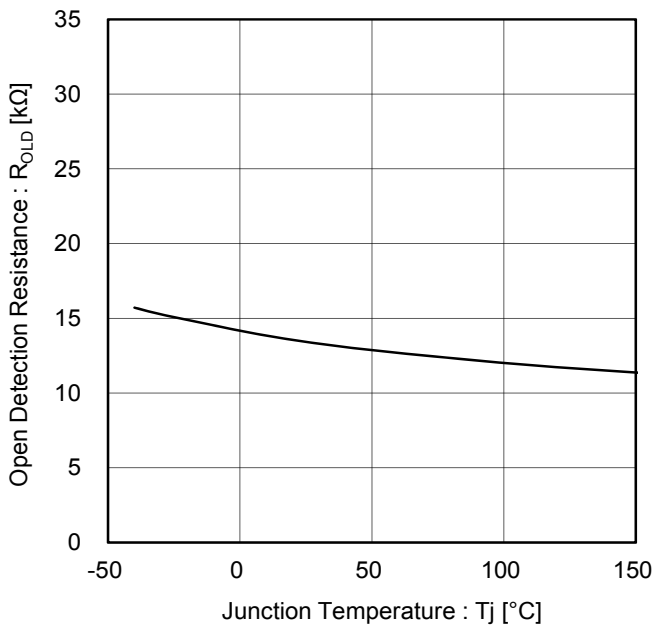

Figure 26. Open Detection Resistance vs. Temperature

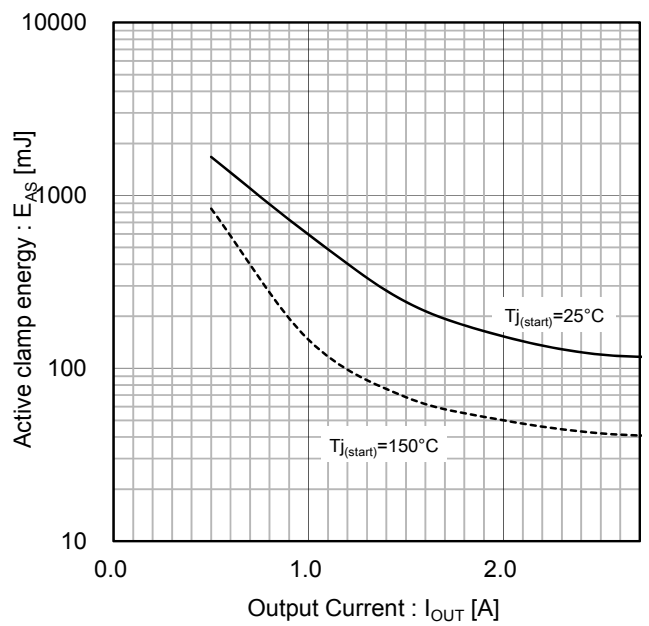

Figure 27. Active Clamp Energy vs. Output Current

Measurement Circuit

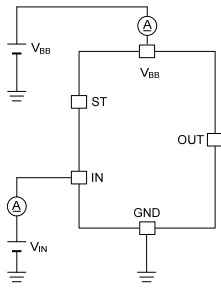

Figure 28. Standby Current
Bias Current
High-level Input Current
Low-level Input Current

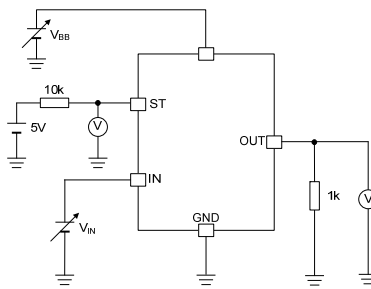

Figure 29. Under Voltage Lockout Threshold
Under Voltage Hysteresis Threshold
High-Level Input Voltage
Low-Level Input Voltage
Input Hysteresis
TSD Detection Temperature
TSD Hysteresis

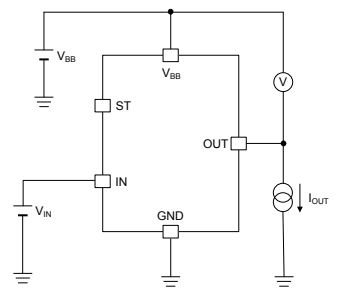

Figure 30. On-state Resistance
Output Clamp Voltage

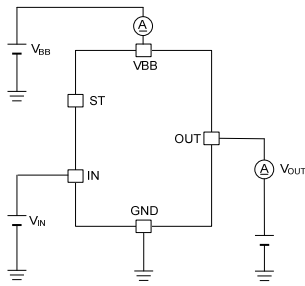

Figure 31. Leak Current

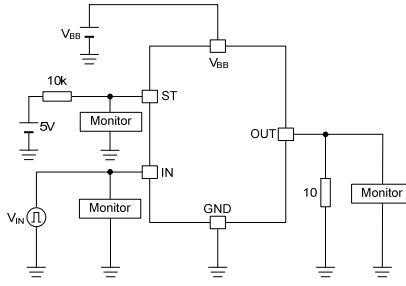

Figure 32. Slew Rate
Propagation Delay at ON
Propagation Delay at OFF
Diagnostic Output Delay Time at Input ON
Diagnostic Output Delay Time at Input OF

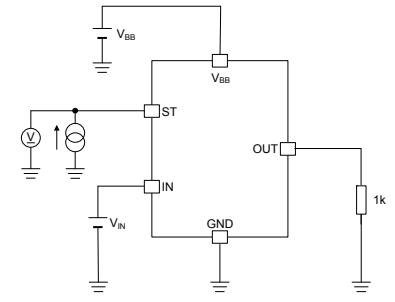

Figure 33. ST ON Voltage

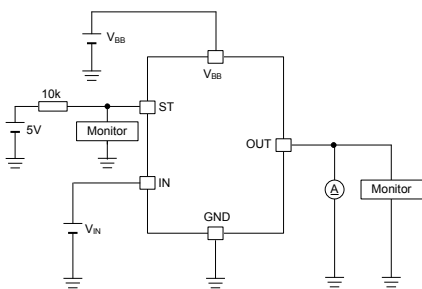

Figure 34. Overcurrent Detection Current
Overcurrent Detection OFF Time
Overcurrent Detection ON Duty

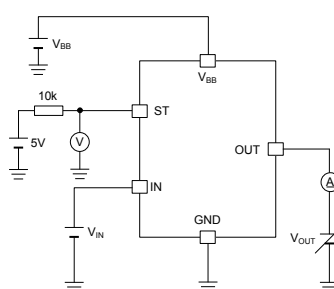

Figure 35. Open Load Detection Resistance
Open Load Detection Voltage

Measurement conditions

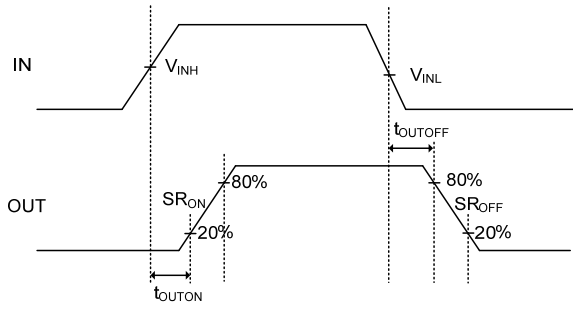

Figure 36. Slew Rate

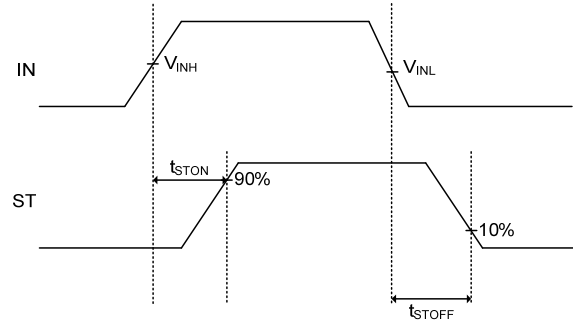

Figure 37. Diagnostic Output Delay Time

I/O Pin Truth Table

Operating Status	Input Signal	Output Level	Diagnostic Output (ST)	Error Detection Reset Condition
Normal	Low	Low	Low	-
	High	High	High	
Overtemperature	Low	Low	Low	Self-Reset
	High	Low	Low	
Overcurrent	Low	Low	Low	Self-Reset
	High	Switching	Low	
Open Load Detected	Low	High	High	Self-Reset
	High	High	High	

Timing Chart

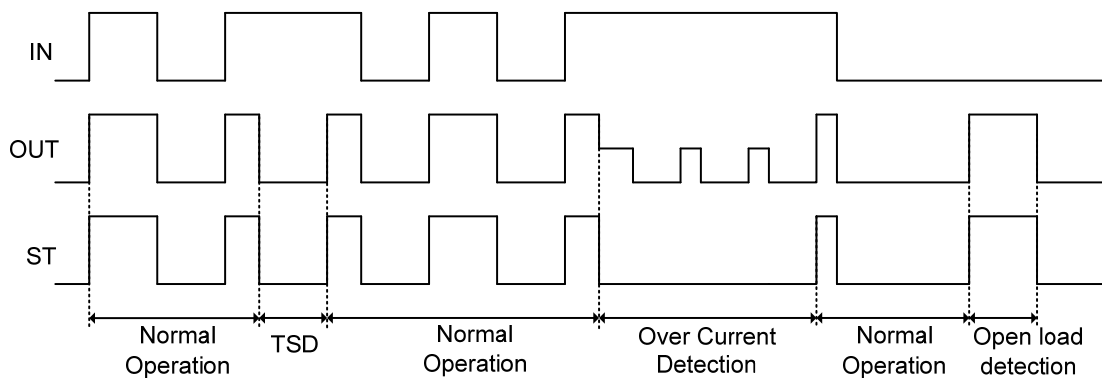
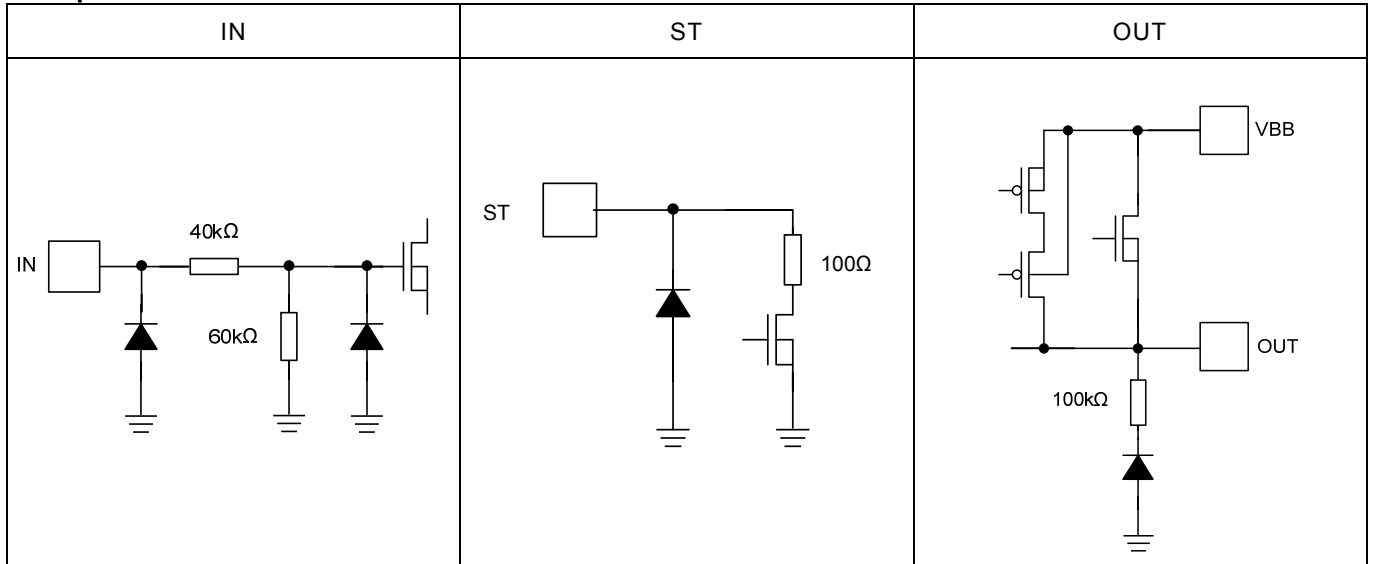

Figure 38. Timing Chart

I/O Equivalent Circuits



Resistance values shown in the diagrams above represent a typical limit, respectively

Figure 39. I/O Equivalent Circuits

Application Circuits

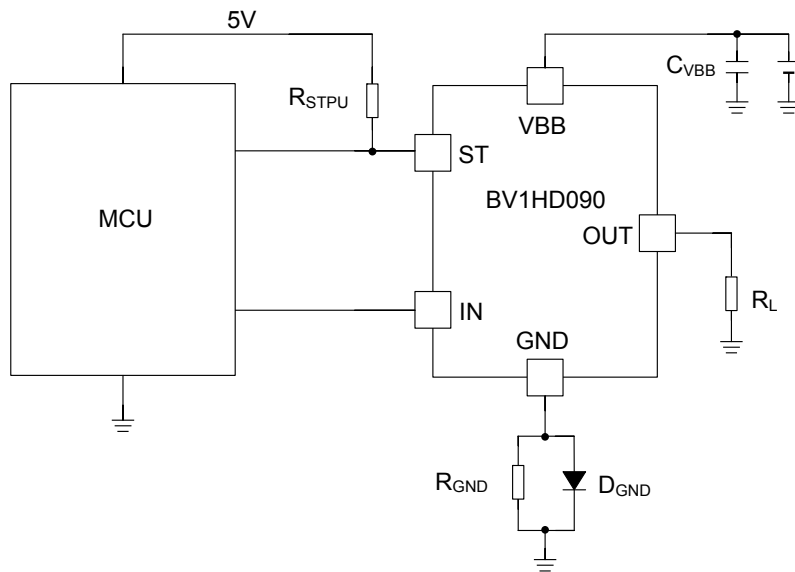

Figure 40. Application Circuits

Symbol	Value	Purpose
R _{STPU}	10kΩ	ST terminal is open drain output. ST terminal is pulled up by MCU power supply.
R _{GND}	1kΩ	Current limitation during reverse battery.
C _{VBB}	100nF	Filter of the voltage spikes on the VBB line.
D _{GND}	-	Protection of the BV1HD090FJ-C during reverse battery.

Precautions for use

1. Ground Wiring Pattern

When both small signal ground and large current ground are provided, it is recommended to isolate the large current ground pattern from the small signal ground pattern and ground at one point at the reference point of the set PCB so as to prevent change of the small signal ground voltage caused by the pattern wiring resistance and large current. Also, pay attention not to change the voltage of ground wiring pattern of the external parts. When wiring the ground line, be sure to set it to low impedance.

2. Thermal Design

The generated calorific value P_c is determined by $P_c \approx V_{DS} \times I_{OUT} + V_{BB} \times I_{BB}$, using $V_{BB} - OUT$ potential difference (V_{DS}), amperage flowing through load (I_{OUT}) and operating current (I_{BB}).

In consideration of the thermal resistance value in the actual service condition, complete the thermal design having sufficient margins.

Should the project be used in the condition exceeding $T_{jmax} = 150\text{ }^\circ\text{C}$, the essential IC properties may be deteriorated.

Since the thermal resistance value described in this specification is measured in the PCB conditions and environments recommended by JEDEC, you should remember that the value in the actual service environments may differ from that.

3. Absolute Maximum Rating

If the temperature value exceeds the absolute maximum rating due to overvoltage applied or rise in temperature, the IC may be broken. If a special mode is assumed where a short circuit between terminals or an excess of the absolute maximum rating may occur, it is recommended to take physical safety measures such as fuses.

4. Inspection Using a Set PCB

In the assembly process, apply grounding as a measure against IC damage caused by static electricity and pay special attention during transportation and storage.

When connecting the IC to or removing the IC from the mount board in the inspection process, be sure to turn OFF the power supply. If a terminal to which a capacitor is connected is included, residual charge may apply stress to the IC. To avoid this, be sure to discharge electricity before performing the following inspection.

5. Mis-mounting and Short Circuit Between Terminals

When mounting the IC on the PCB, pay special attention to the IC direction, displacement and short circuit between terminals. Mis-mounting or short circuit between terminals may cause IC damage.

6. Ceramic Capacitor Characteristic Variation

When using a ceramic capacitor as the external component, determine the constant in consideration of lowering of nominal capacity due to direct current bias and change of capacity caused by thermal conditions.

7. Thermal Shut Down Function

The IC integrates the thermal shut down function. When the IC chip temperature exceeds $190\text{ }^\circ\text{C}$ (Typ), the function turns OFF the output and sets the diagnostic output (ST) to Low. When the temperature becomes lower than $175\text{ }^\circ\text{C}$ (Typ), the IC returns to the normal operation.

The thermal shut down function is provided only in order to shut down a thermal runaway, not in order to protect or secure the IC. Since the thermal shut down function turns ON in the state exceeding the absolute maximum rating, be sure to avoid designing a set PCB pre-requiring use of this function.

8. Overcurrent Protection Function

The IC integrates the overcurrent protection function. When overcurrent flows, the function limits the output current to 5.5A (Typ), turns OFF the output if the limited state continues for $3\mu\text{s}$ (Typ) or longer and sets the diagnostic output (ST) to Low. If the output OFF state continues for $550\mu\text{s}$ (Typ), the IC resets itself. During the erroneous state where overcurrent flows, the function turns ON/OFF the output repeatedly.

The overcurrent protection function is to protect the IC from damage caused only by a sudden abnormality such as a load short circuit and short circuit between terminals. Be sure to avoid designing a set PCB pre-requiring use of this function.

9. Active Clamp Operation

The IC integrates the active clamp circuit to internally absorb the counter electromotive force generated when the inductive load is turned OFF. When the active clamp operates, $V_{BB} - OUT$ voltage becomes 50V (Typ) and the IC chip temperature rises. However, since this is the operation at $I_N=0\text{V}$, the thermal shut down function does not turn ON. To drive the inductive load, refer to Figure. 27 to determine the load which will be below the active clamp tolerance dose.

10. Power Supply Line

Since the power supply line where large current flows may influence the normal operation, design the power supply line so that the power supply pattern wiring resistance will become smaller.

11. Reverse Connection of Power Connector (VBB - GND)

A reverse connection of the power connector (between VBB and GND) incurs a risk to break the IC.

In order to prevent the IC from damage at reverse connection, take an appropriate measure, for example, to insert a diode and resistor between the GND terminal of the PCB ground and that of the IC, or to insert a diode between VBB of the power supply and that of the IC. (Refer to Figure No.40)

12. Power Terminal in The Open State

When the power terminal (VBB) becomes open at ON (IN=High), the output is switched to OFF irrespective of input voltage.

If an inductive load is connected, the active clamp operates when VBB is open, and then becomes the same potential as that on the ground and the output voltage drops down to - 50V (Typ).

13. GND Terminal in The Open State

When the GND terminal becomes open at ON (IN=High), the output is switched to OFF irrespective of input voltage. If an inductive load is connected, the active clamp operates when the GND terminal is open.

Ordering Information

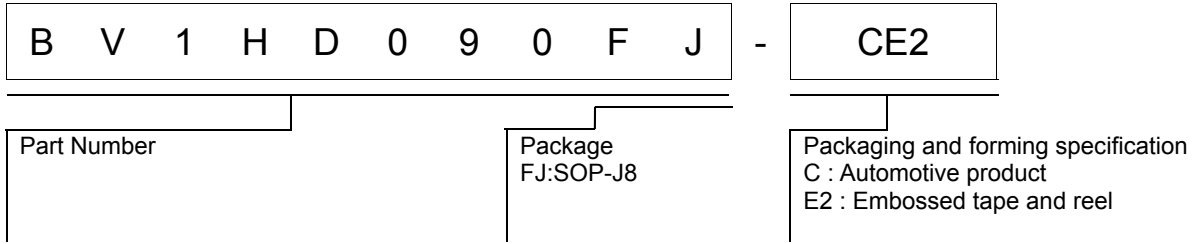

Marking Diagrams

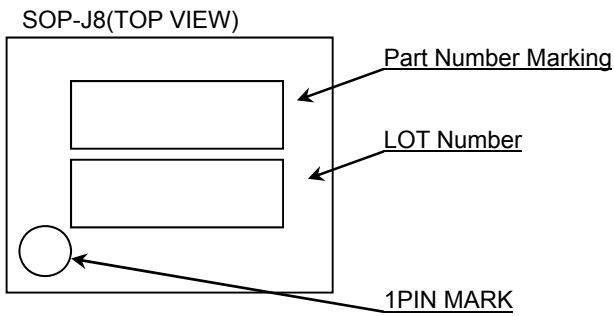

Part Number Marking	Package	Orderable Part Number
1HD90	SOP-J8	BV1HD090FJ-CE2

Physical Dimension, Tape and Reel Information

Package Name	SOP-J8
--------------	--------

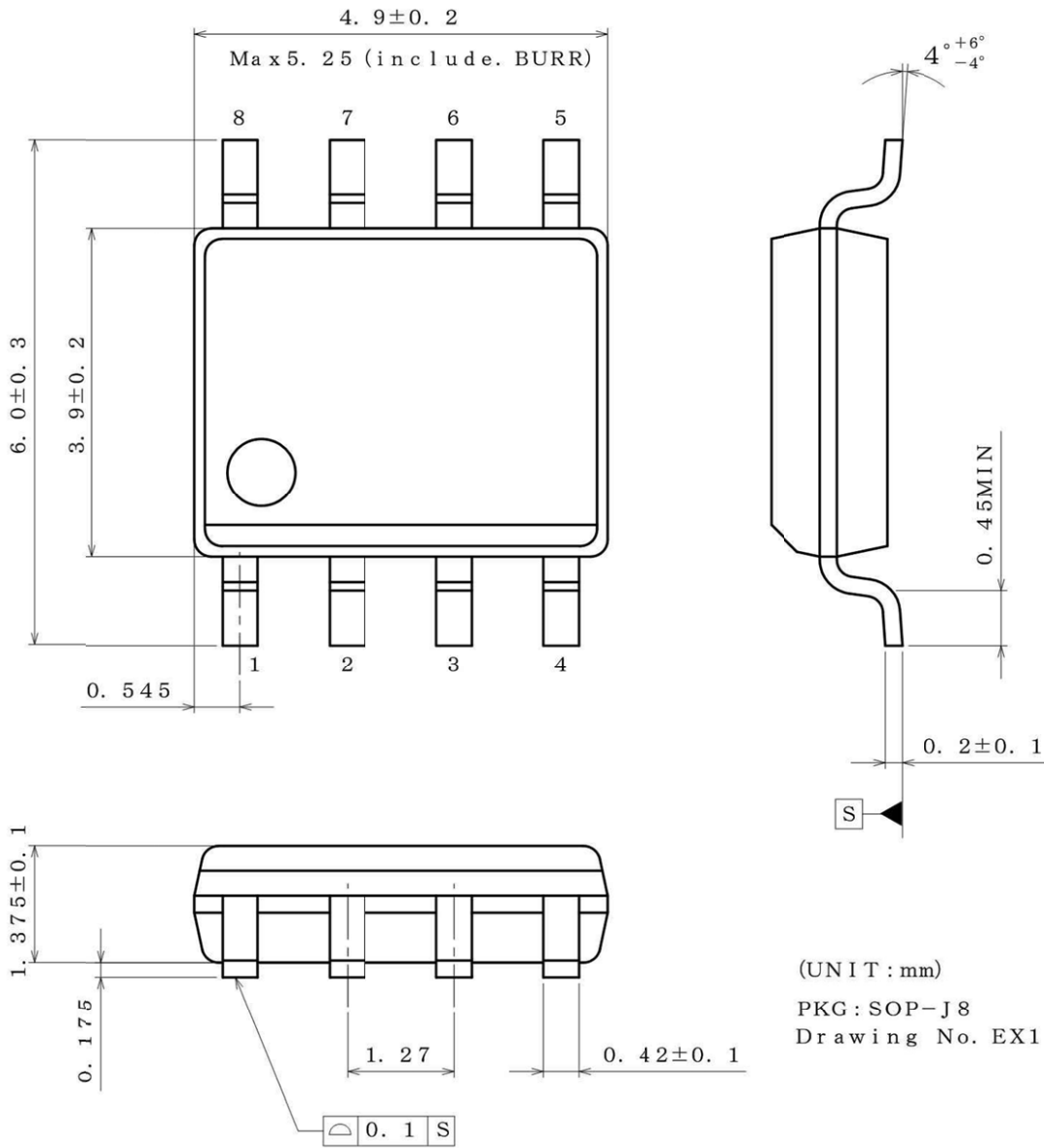

(UNIT : mm)
 PKG : SOP-J8
 Drawing No. EX111-5002

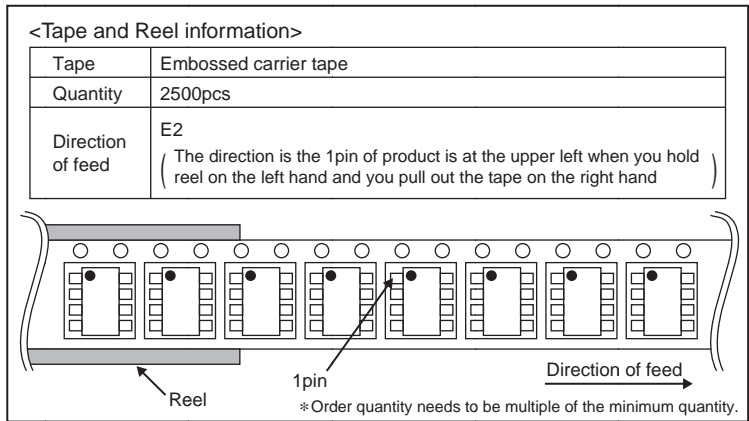

Revision History

Date	Revision	Changes
27.Dec.2016	001	New Release

Notice

Precaution on using ROHM Products

1. If you intend to use our Products in devices requiring extremely high reliability (such as medical equipment ^(Note 1), aircraft/spacecraft, nuclear power controllers, etc.) and whose malfunction or failure may cause loss of human life, bodily injury or serious damage to property ("Specific Applications"), please consult with the ROHM sales representative in advance. Unless otherwise agreed in writing by ROHM in advance, ROHM shall not be in any way responsible or liable for any damages, expenses or losses incurred by you or third parties arising from the use of any ROHM's Products for Specific Applications.

(Note1) Medical Equipment Classification of the Specific Applications

JAPAN	USA	EU	CHINA
CLASS III	CLASS III	CLASS II b	CLASS III
CLASS IV		CLASS III	

2. ROHM designs and manufactures its Products subject to strict quality control system. However, semiconductor products can fail or malfunction at a certain rate. Please be sure to implement, at your own responsibilities, adequate safety measures including but not limited to fail-safe design against the physical injury, damage to any property, which a failure or malfunction of our Products may cause. The following are examples of safety measures:
 - [a] Installation of protection circuits or other protective devices to improve system safety
 - [b] Installation of redundant circuits to reduce the impact of single or multiple circuit failure
3. Our Products are not designed under any special or extraordinary environments or conditions, as exemplified below. Accordingly, ROHM shall not be in any way responsible or liable for any damages, expenses or losses arising from the use of any ROHM's Products under any special or extraordinary environments or conditions. If you intend to use our Products under any special or extraordinary environments or conditions (as exemplified below), your independent verification and confirmation of product performance, reliability, etc. prior to use, must be necessary:
 - [a] Use of our Products in any types of liquid, including water, oils, chemicals, and organic solvents
 - [b] Use of our Products outdoors or in places where the Products are exposed to direct sunlight or dust
 - [c] Use of our Products in places where the Products are exposed to sea wind or corrosive gases, including Cl₂, H₂S, NH₃, SO₂, and NO₂
 - [d] Use of our Products in places where the Products are exposed to static electricity or electromagnetic waves
 - [e] Use of our Products in proximity to heat-producing components, plastic cords, or other flammable items
 - [f] Sealing or coating our Products with resin or other coating materials
 - [g] Use of our Products without cleaning residue of flux (even if you use no-clean type fluxes, cleaning residue of flux is recommended); or Washing our Products by using water or water-soluble cleaning agents for cleaning residue after soldering
 - [h] Use of the Products in places subject to dew condensation
4. The Products are not subject to radiation-proof design.
5. Please verify and confirm characteristics of the final or mounted products in using the Products.
6. In particular, if a transient load (a large amount of load applied in a short period of time, such as pulse. is applied, confirmation of performance characteristics after on-board mounting is strongly recommended. Avoid applying power exceeding normal rated power; exceeding the power rating under steady-state loading condition may negatively affect product performance and reliability.
7. De-rate Power Dissipation depending on ambient temperature. When used in sealed area, confirm that it is the use in the range that does not exceed the maximum junction temperature.
8. Confirm that operation temperature is within the specified range described in the product specification.
9. ROHM shall not be in any way responsible or liable for failure induced under deviant condition from what is defined in this document.

Precaution for Mounting / Circuit board design

1. When a highly active halogenous (chlorine, bromine, etc.) flux is used, the residue of flux may negatively affect product performance and reliability.
2. In principle, the reflow soldering method must be used on a surface-mount products, the flow soldering method must be used on a through hole mount products. If the flow soldering method is preferred on a surface-mount products, please consult with the ROHM representative in advance.

For details, please refer to ROHM Mounting specification

Precautions Regarding Application Examples and External Circuits

1. If change is made to the constant of an external circuit, please allow a sufficient margin considering variations of the characteristics of the Products and external components, including transient characteristics, as well as static characteristics.
2. You agree that application notes, reference designs, and associated data and information contained in this document are presented only as guidance for Products use. Therefore, in case you use such information, you are solely responsible for it and you must exercise your own independent verification and judgment in the use of such information contained in this document. ROHM shall not be in any way responsible or liable for any damages, expenses or losses incurred by you or third parties arising from the use of such information.

Precaution for Electrostatic

This Product is electrostatic sensitive product, which may be damaged due to electrostatic discharge. Please take proper caution in your manufacturing process and storage so that voltage exceeding the Products maximum rating will not be applied to Products. Please take special care under dry condition (e.g. Grounding of human body / equipment / solder iron, isolation from charged objects, setting of Ionizer, friction prevention and temperature / humidity control).

Precaution for Storage / Transportation

1. Product performance and soldered connections may deteriorate if the Products are stored in the places where:
 - [a] the Products are exposed to sea winds or corrosive gases, including Cl₂, H₂S, NH₃, SO₂, and NO₂
 - [b] the temperature or humidity exceeds those recommended by ROHM
 - [c] the Products are exposed to direct sunshine or condensation
 - [d] the Products are exposed to high Electrostatic
2. Even under ROHM recommended storage condition, solderability of products out of recommended storage time period may be degraded. It is strongly recommended to confirm solderability before using Products of which storage time is exceeding the recommended storage time period.
3. Store / transport cartons in the correct direction, which is indicated on a carton with a symbol. Otherwise bent leads may occur due to excessive stress applied when dropping of a carton.
4. Use Products within the specified time after opening a humidity barrier bag. Baking is required before using Products of which storage time is exceeding the recommended storage time period.

Precaution for Product Label

A two-dimensional barcode printed on ROHM Products label is for ROHM's internal use only.

Precaution for Disposition

When disposing Products please dispose them properly using an authorized industry waste company.

Precaution for Foreign Exchange and Foreign Trade act

Since concerned goods might be fallen under listed items of export control prescribed by Foreign exchange and Foreign trade act, please consult with ROHM in case of export.

Precaution Regarding Intellectual Property Rights

1. All information and data including but not limited to application example contained in this document is for reference only. ROHM does not warrant that foregoing information or data will not infringe any intellectual property rights or any other rights of any third party regarding such information or data.
2. ROHM shall not have any obligations where the claims, actions or demands arising from the combination of the Products with other articles such as components, circuits, systems or external equipment (including software).
3. No license, expressly or implied, is granted hereby under any intellectual property rights or other rights of ROHM or any third parties with respect to the Products or the information contained in this document. Provided, however, that ROHM will not assert its intellectual property rights or other rights against you or your customers to the extent necessary to manufacture or sell products containing the Products, subject to the terms and conditions herein.

Other Precaution

1. This document may not be reprinted or reproduced, in whole or in part, without prior written consent of ROHM.
2. The Products may not be disassembled, converted, modified, reproduced or otherwise changed without prior written consent of ROHM.
3. In no event shall you use in any way whatsoever the Products and the related technical information contained in the Products or this document for any military purposes, including but not limited to, the development of mass-destruction weapons.
4. The proper names of companies or products described in this document are trademarks or registered trademarks of ROHM, its affiliated companies or third parties.

General Precaution

1. Before you use our Products, you are requested to carefully read this document and fully understand its contents. ROHM shall not be in any way responsible or liable for failure, malfunction or accident arising from the use of any ROHM's Products against warning, caution or note contained in this document.
2. All information contained in this document is current as of the issuing date and subject to change without any prior notice. Before purchasing or using ROHM's Products, please confirm the latest information with a ROHM sales representative.
3. The information contained in this document is provided on an "as is" basis and ROHM does not warrant that all information contained in this document is accurate and/or error-free. ROHM shall not be in any way responsible or liable for any damages, expenses or losses incurred by you or third parties resulting from inaccuracy or errors of or concerning such information.