

# TPS2294x Low-input-voltage Current-limited Load Switches With Shut Off And Auto-Restart Feature

## 1 Features

- Input Voltage Range: 1.62 V to 5.5 V
- Low ON resistance
  - $r_{ON} = 0.4 \Omega$  at  $V_{IN} = 5.5 \text{ V}$
  - $r_{ON} = 0.5 \Omega$  at  $V_{IN} = 3.3 \text{ V}$
  - $r_{ON} = 0.6 \Omega$  at  $V_{IN} = 2.5 \text{ V}$
  - $r_{ON} = 0.8 \Omega$  at  $V_{IN} = 1.8 \text{ V}$
- Minimum Current Limit: 40 mA or 100 mA
- Undervoltage Lockout (UVLO)
- Thermal Shutdown
- Shutdown Current < 1  $\mu\text{A}$
- Fast Current Limit Response Time
- Fault Blanking
- Auto Restart
- 1.8-V Compatible Control Input Thresholds
- ESD Performance Tested Per JESD 22
  - 4000-V Human-Body Model (A114-B, Class II)
  - 1000-V Charged-Device Model (C101)
- Tiny SC-70 (DCK) Package
- UL Recognized Component (UL File 169910)
- Evaluated to IEC 60950-1, Ed 2, Am1, Annex CC, Test Program 2 with CB Report

## 2 Applications

- Low-Current Sensor Protection
- HDMI Connector Protection
- Notebooks
- PDAs
- GPS Devices
- MP3 Players
- Peripheral Ports

## 3 Description

The TPS22941/2/3/4/5 load switches provide protection to systems and loads in high-current conditions. The devices contain a 0.4- $\Omega$  current-limited P-channel MOSFET that can operate over an input voltage range of 1.62 V to 5.5 V. Current is prevented from flowing when the MOSFET is off. The switch is controlled by an on/off input (ON), which is capable of interfacing directly with low-voltage control signals. The TPS22941/2/3/4/5 includes thermal shutdown protection that prevents damage to the device when a continuous over-current condition causes excessive heating by turning off the switch.

These devices provide an integrated, robust solution to provide current limiting the output current to a safe level by switching into a constant-current mode when the output load exceeds the current-limit threshold. The OC logic output asserts low during overcurrent, undervoltage, or overtemperature conditions. These additional features make the TPS22941/2/3/4/5 an ideal solution for applications where current limiting is necessary.

This family of devices are available in a SC70-5 (DCK) package. It is characterized for operation over the free-air temperature range of  $-40^{\circ}\text{C}$  to  $85^{\circ}\text{C}$ .

### Device Information<sup>(1)</sup>

PART NUMBER	PACKAGE	BODY SIZE (NOM)
TPS22941	SC70 (5)	2.00mm x 2.10 mm
TPS22942		
TPS22943		
TPS22944		
TPS22945		

(1) For all available packages, see the orderable addendum at the end of the datasheet.

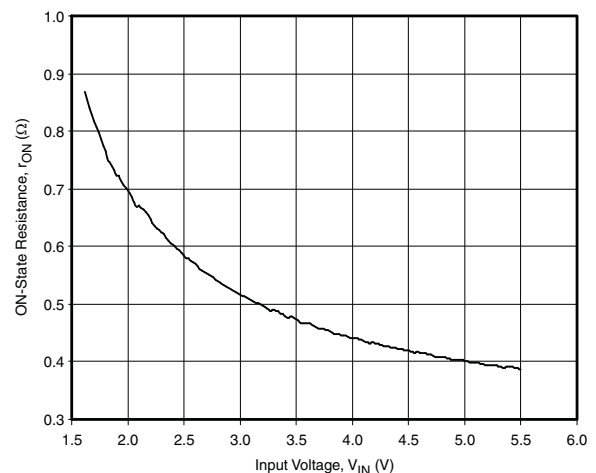

## Table of Contents

<b>1 Features</b> .....	<b>1</b>	8.3 Feature Description .....	<b>9</b>
<b>2 Applications</b> .....	<b>1</b>	8.4 Device Functional Modes .....	<b>10</b>
<b>3 Description</b> .....	<b>1</b>	<b>9 Application and Implementation</b> .....	<b>11</b>
<b>4 Revision History</b> .....	<b>2</b>	9.1 Application Information .....	<b>11</b>
<b>5 Device Comparison Table</b> .....	<b>3</b>	9.2 Typical Application .....	<b>11</b>
<b>6 Pin Configuration and Functions</b> .....	<b>3</b>	<b>10 Power Supply Recommendations</b> .....	<b>15</b>
<b>7 Specifications</b> .....	<b>3</b>	<b>11 Layout</b> .....	<b>15</b>
7.1 Absolute Maximum Ratings .....	<b>3</b>	11.1 Layout Guidelines .....	<b>15</b>
7.2 Handling Ratings .....	<b>3</b>	11.2 Layout Example .....	<b>15</b>
7.3 Recommended Operating Conditions .....	<b>4</b>	11.3 Thermal Considerations .....	<b>16</b>
7.4 Thermal Information .....	<b>4</b>	<b>12 Device and Documentation Support</b> .....	<b>17</b>
7.5 Electrical Characteristics .....	<b>4</b>	12.1 Related Links .....	<b>17</b>
7.6 Switching Characteristics .....	<b>5</b>	12.2 Trademarks .....	<b>17</b>
7.7 Typical Characteristics .....	<b>6</b>	12.3 Electrostatic Discharge Caution .....	<b>17</b>
<b>8 Detailed Description</b> .....	<b>9</b>	12.4 Glossary .....	<b>17</b>
8.1 Overview .....	<b>9</b>	<b>13 Mechanical, Packaging, and Orderable Information</b> .....	<b>17</b>
8.2 Functional Block Diagram .....	<b>9</b>		

## 4 Revision History

### Changes from Revision C (November 2009) to Revision D

**Page**

- Added *Handling Rating* table, *Feature Description* section, *Device Functional Modes*, *Application and Implementation* section, *Power Supply Recommendations* section, *Layout* section, *Device and Documentation Support* section, and *Mechanical, Packaging, and Orderable Information* section ..... **1**

## 5 Device Comparison Table

DEVICE	MINIMUM CURRENT LIMIT (mA)	CURRENT LIMIT BLANKING TIME (ms)	AUTO-RESTART TIME (ms)	ON PIN ACTIVITY
TPS22941	40	10	80	Active LOW
TPS22942	100	10	80	Active LOW
TPS22943	40	0	N/A	Active HIGH
TPS22944	100	0	N/A	Active HIGH
TPS22945	100	10	80	Active HIGH

## 6 Pin Configuration and Functions

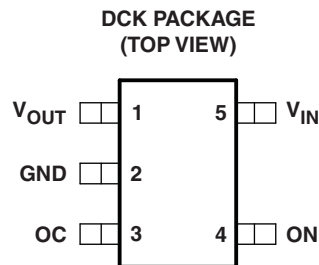

PIN		TYPE	DESCRIPTION
NAME	SOT (DCK) PIN NO.		
V <sub>OUT</sub>	1	O	Switch Output. Place ceramic bypass capacitor(s) between this terminal and GND. See the <a href="#">Application Information</a> section for more information.
GND	2	–	Ground
OC	3	O	Over current output flag: active LOW, open drain output that indicates an over current, supply under voltage, or over temperature state.
ON	4	I	Switch control input. Do not leave floating.
V <sub>IN</sub>	5	I	Switch Input. Place ceramic bypass capacitor(s) between this terminal and GND. See the <a href="#">Application Information</a> section for more information.

## 7 Specifications

### 7.1 Absolute Maximum Ratings<sup>(1)</sup>

		MIN	MAX	UNIT	
V <sub>I</sub>	Input voltage range	V <sub>IN</sub> , V <sub>OUT</sub> , ON	–0.3	6	V
T <sub>J</sub>	Operating junction temperature range		Internally Limited		°C

- (1) Stresses beyond those listed under absolute maximum ratings may cause permanent damage to the device. These are stress ratings only, and functional operation of the device at these or any other conditions beyond those indicated under *Recommended Operating Conditions* is not implied. Exposure to absolute-maximum-rated conditions for extended periods may affect device reliability.

### 7.2 Handling Ratings

		MIN	MAX	UNIT	
T <sub>stg</sub>	Storage temperature range	–65	150	°C	
V <sub>ESD</sub>	Electrostatic discharge	Human body model (HBM), per ANSI/ESDA/JEDEC JS-001, all pins <sup>(1)</sup>	–4	4	kV
		Charged device model (CDM), per JEDEC specification JESD22-C101, all pins <sup>(2)</sup>	–1	1	

(1) JEDEC document JEP155 states that 500-V HBM allows safe manufacturing with a standard ESD control process.

(2) JEDEC document JEP157 states that 250-V CDM allows safe manufacturing with a standard ESD control process.

### 7.3 Recommended Operating Conditions

Over operating free-air temperature range (unless otherwise noted)

		MIN	MAX	UNIT
V <sub>IN</sub>	Input voltage	1.62	5.5	V
V <sub>OUT</sub>	Output voltage		V <sub>IN</sub>	
T <sub>A</sub>	Ambient free-air temperature	–40	85	°C

### 7.4 Thermal Information

THERMAL METRIC <sup>(1)</sup>		TPS22941/2/3/4/5	UNIT
		DCK	
		5 PINS	
θ <sub>JA</sub>	Junction-to-ambient thermal resistance	294	°C/W
θ <sub>JC(top)</sub>	Junction-to-case (top) thermal resistance	59.2	
θ <sub>JB</sub>	Junction-to-board thermal resistance	95.4	
ψ <sub>JT</sub>	Junction-to-top characterization parameter	0.7	
ψ <sub>JB</sub>	Junction-to-board characterization parameter	93.9	
θ <sub>JC(bot)</sub>	Junction-to-case (bottom) thermal resistance	N/A	

 (1) For more information about traditional and new thermal metrics, see the *IC Package Thermal Metrics* application report, [SPRA953](#).

### 7.5 Electrical Characteristics

 V<sub>IN</sub> = 1.62 V to 5.5 V, T<sub>A</sub> = –40°C to 85°C (unless otherwise noted)

PARAMETER	TEST CONDITIONS		T <sub>A</sub>	MIN	TYP <sup>(1)</sup>	MAX	UNIT	
I <sub>IN</sub>	Quiescent current	I <sub>OUT</sub> = 0 mA, V <sub>IN</sub> = 1.62 V to 5.5 V	Full		40	80	μA	
I <sub>IN(OFF)</sub>	OFF-State supply current	V <sub>ON</sub> = 0 V (TPS22943/4/5) or V <sub>ON</sub> = V <sub>IN</sub> (TPS22941/2) V <sub>IN</sub> = 3.6 V, V <sub>OUT</sub> open	Full			1	μA	
I <sub>OUT(LEAKAGE)</sub>	OFF-State switch current	V <sub>ON</sub> = 0 V (TPS22943/4/5) or V <sub>ON</sub> = V <sub>IN</sub> (TPS22941/2) V <sub>IN</sub> = 3.6 V, V <sub>OUT</sub> short to GND	Full			1	μA	
r <sub>ON</sub>	ON-state resistance	I <sub>OUT</sub> = 20 mA	V <sub>IN</sub> = 5.5 V	25°C	0.4	0.5	Ω	
				Full		0.6		
			V <sub>IN</sub> = 3.3 V	25°C	0.5	0.6		
				Full		0.7		
			V <sub>IN</sub> = 2.5 V	25°C	0.6	0.7		
				Full		0.8		
			V <sub>IN</sub> = 1.8 V	25°C	0.8	0.9		
				Full		1.1		
		V <sub>IN</sub> = 1.62 V	25°C	0.9	1.1			
			Full			1.2		
I <sub>ON</sub>	ON input leakage current	V <sub>ON</sub> = V <sub>IN</sub> or GND	Full			1	μA	
I <sub>LIM</sub>	Current limit	V <sub>IN</sub> = 3.3 V, V <sub>OUT</sub> = 3 V	TPS22941/3	Full	40	65	80	mA
			TPS22942/4/5		100	150	200	
T <sub>SD</sub>	Thermal shutdown	Shutdown threshold	Full		140		°C	
		Return from shutdown			130			
		Hysteresis			10			

 (1) Typical values are at V<sub>IN</sub> = 3.3 V and T<sub>A</sub> = 25°C.

## Electrical Characteristics (continued)

 $V_{IN} = 1.62\text{ V to }5.5\text{ V}$ ,  $T_A = -40^\circ\text{C to }85^\circ\text{C}$  (unless otherwise noted)

PARAMETER		TEST CONDITIONS	$T_A$	MIN	TYP <sup>(1)</sup>	MAX	UNIT
UVLO	Undervoltage shutdown	$V_{IN}$ increasing	Full	1.32	1.42	1.52	V
	Undervoltage shutdown hysteresis		Full	45			mV
<b>Control Output (OC)</b>							
Vol	OC output logic low voltage	$V_{IN} = 5\text{ V}$ , $I_{SINK} = 10\text{ mA}$	Full	0.1		0.2	V
		$V_{IN} = 1.8\text{ V}$ , $I_{SINK} = 10\text{ mA}$		0.1		0.3	
IoZ	OC output high leakage current voltage	$V_{IN} = 5\text{ V}$ , Switch ON	Full			0.5	$\mu\text{A}$
<b>Control Input (ON)</b>							
Vih	ON high-level input voltage	$V_{IN} = 1.8\text{ V}$	Full	1.1			V
		$V_{IN} = 2.5\text{ V}$	Full	1.3			V
		$V_{IN} = 3.3\text{ V}$	Full	1.4			V
		$V_{IN} = 5.5\text{ V}$	Full	1.7			V
Vil	ON low-level input voltage	$V_{IN} = 1.8\text{ V}$	Full			0.5	V
		$V_{IN} = 2.5\text{ V}$	Full			0.7	V
		$V_{IN} = 3.3\text{ V}$	Full			0.8	V
		$V_{IN} = 5.5\text{ V}$	Full			0.9	V
li	ON high-level input leakage current	$V_{IN} = 1.8\text{ V to }5\text{ V}$ , Switch ON	Full			1	$\mu\text{A}$

## 7.6 Switching Characteristics

 $V_{IN} = 3.3\text{ V}$ ,  $R_L = 500\ \Omega$ ,  $C_L = 0.1\ \mu\text{F}$ ,  $T_A = 25^\circ\text{C}$  (unless otherwise noted)

PARAMETER		TEST CONDITIONS	MIN	TYP	MAX	UNIT
$t_{ON}$	Turn-ON time	$R_L = 500\ \Omega$ , $C_L = 0.1\ \mu\text{F}$		60		$\mu\text{s}$
$t_{OFF}$	Turn-OFF time	$R_L = 500\ \Omega$ , $C_L = 0.1\ \mu\text{F}$		30		$\mu\text{s}$
$t_r$	$V_{OUT}$ rise time	$R_L = 500\ \Omega$ , $C_L = 0.1\ \mu\text{F}$		10		$\mu\text{s}$
$t_f$	$V_{OUT}$ fall time	$R_L = 500\ \Omega$ , $C_L = 0.1\ \mu\text{F}$		90		$\mu\text{s}$
$t_{BLANK}$	Over current blanking time	TPS22941/2/5	5	10	20	ms
$t_{RSTART}$	Auto-restart time	TPS22941/2/5	40	80	160	ms
	Short-circuit response time	$V_{IN} = V_{ON} = 3.3\text{ V}$ , moderate overcurrent condition	9			$\mu\text{s}$
		$V_{IN} = V_{ON} = 3.3\text{ V}$ , hard short	4			$\mu\text{s}$

## 7.7 Typical Characteristics

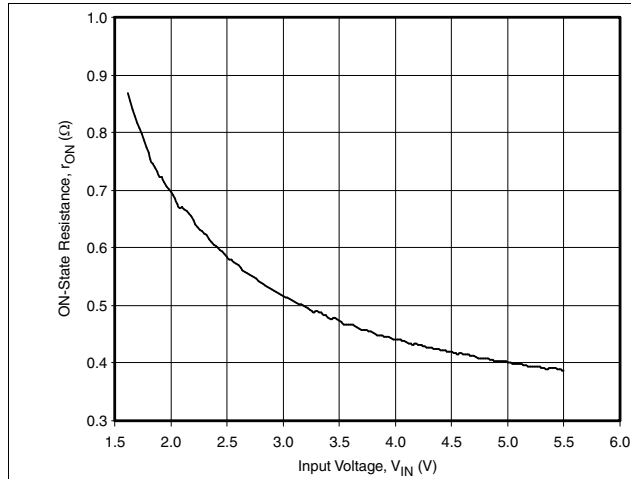

Figure 1.  $r_{ON}$  vs  $V_{IN}$

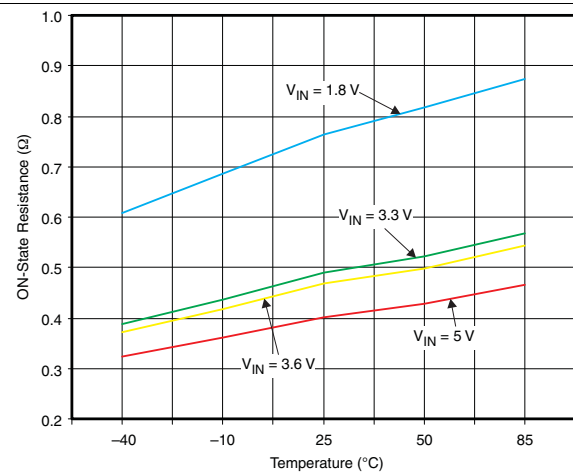

Figure 2.  $r_{ON}$  vs Temperature

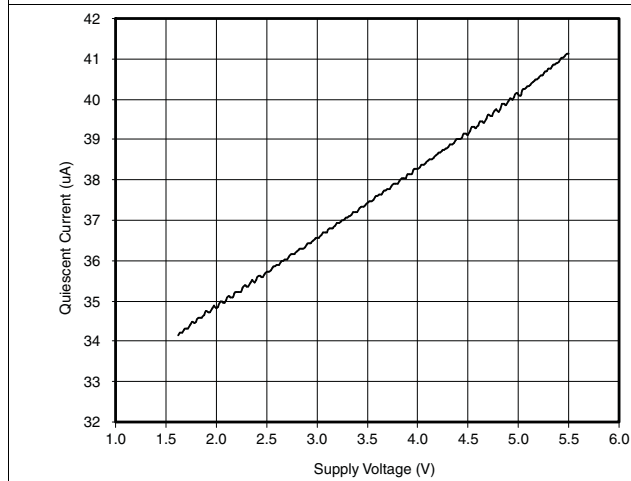

Figure 3. Quiescent Current vs  $V_{IN}$

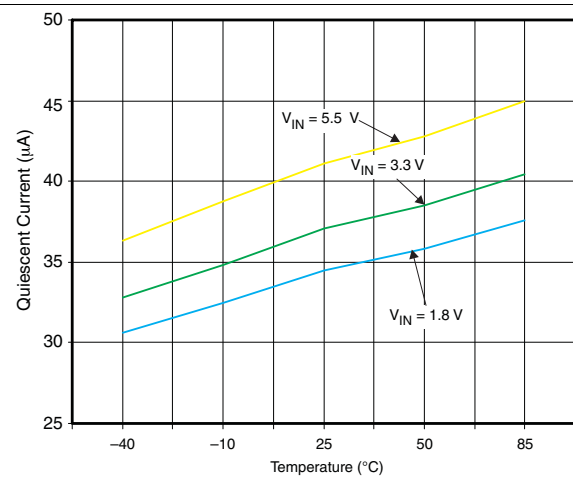

Figure 4. Quiescent Current vs Temperature

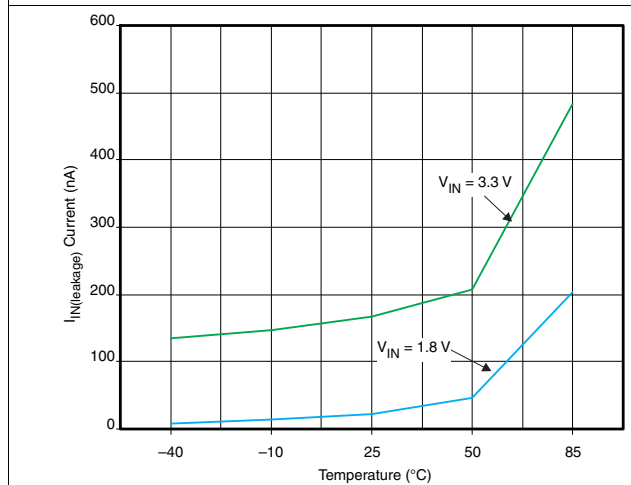

Figure 5.  $I_{IN(Leakage)}$  vs Temperature

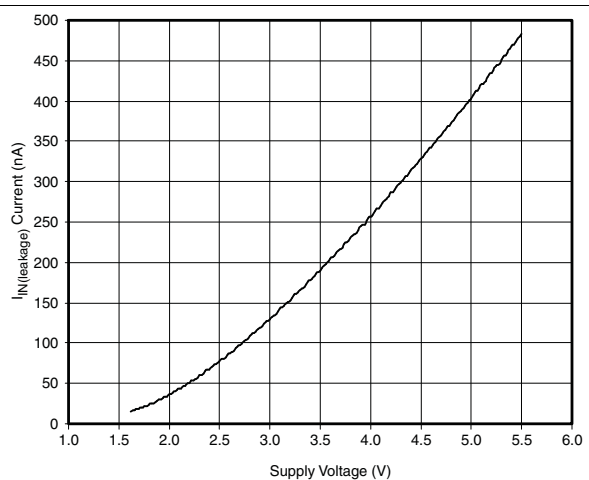

Figure 6.  $I_{IN(Leakage)}$  vs  $V_{IN}$

Typical Characteristics (continued)

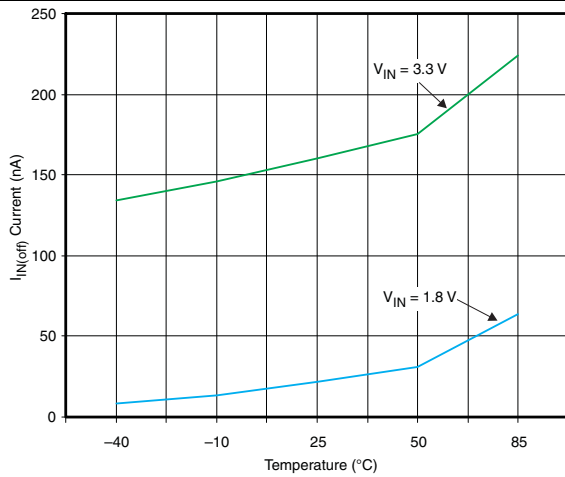

Figure 7.  $I_{IN(off)}$  vs Temperature

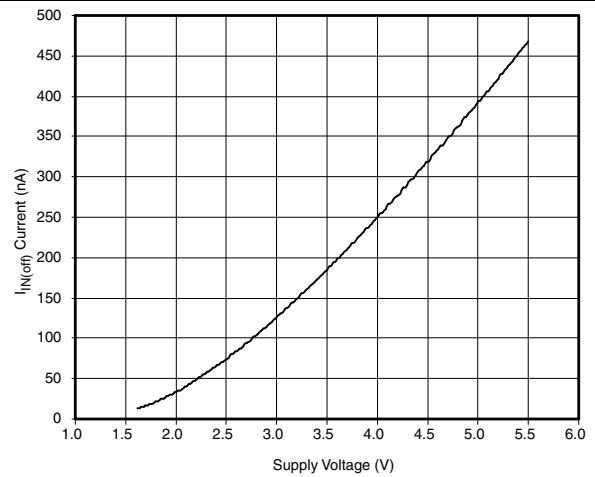

Figure 8.  $I_{IN(off)}$  vs  $V_{IN}$

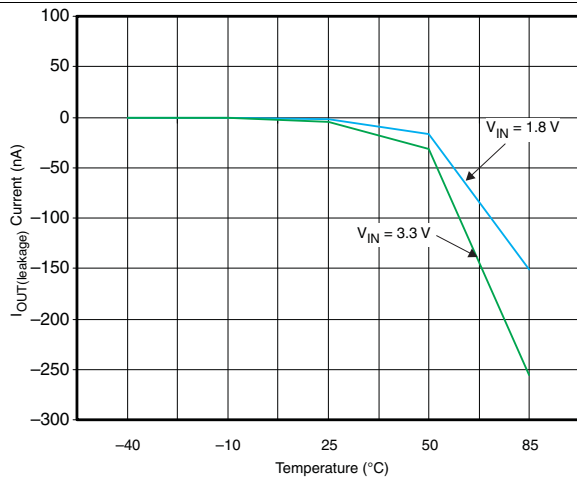

Figure 9.  $I_{OUT(leakage)}$  vs Temperature

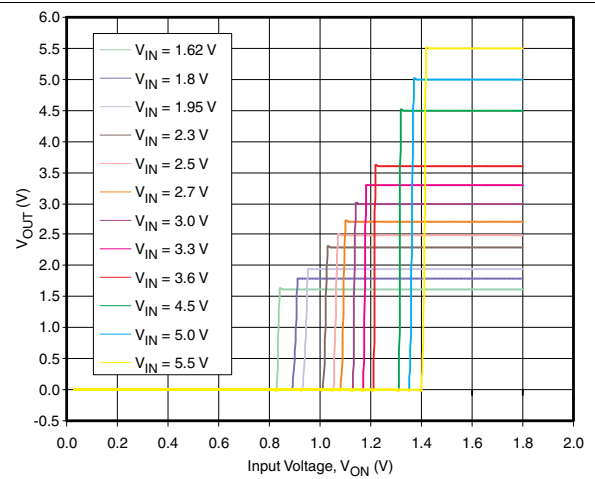

Figure 10.  $V_{OUT}$  vs ON Threshold

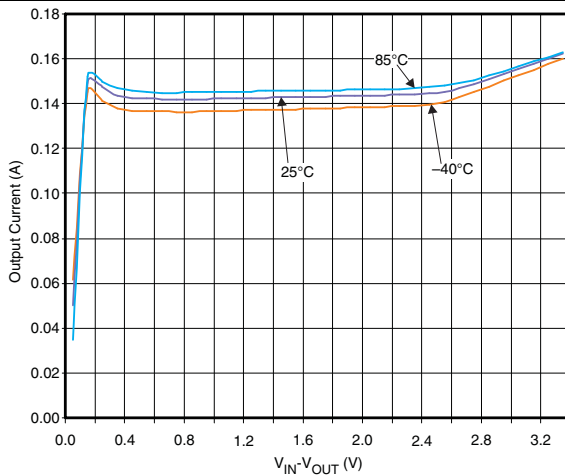

Figure 11.  $I_{LIM}$  vs Output Voltage (TPS22942, TPS22944, TPS22945)

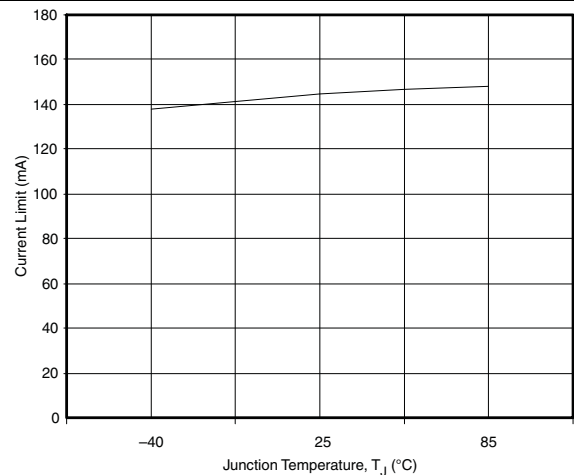

Figure 12.  $I_{LIM}$  vs Temperature (TPS22942, TPS22944, TPS22945)

Typical Characteristics (continued)

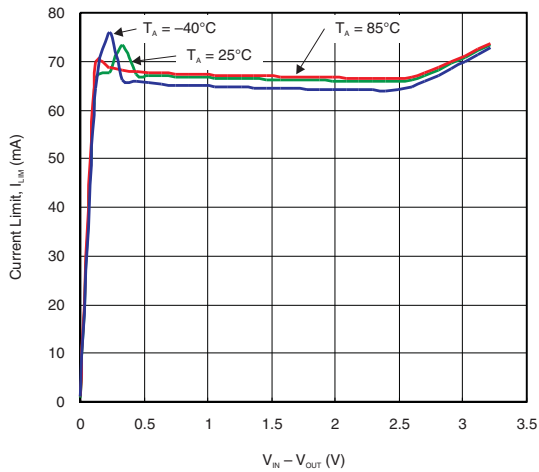

Figure 13.  $I_{LIM}$  vs  $(V_{IN} - V_{OUT})$  (TPS22941, TPS22943)

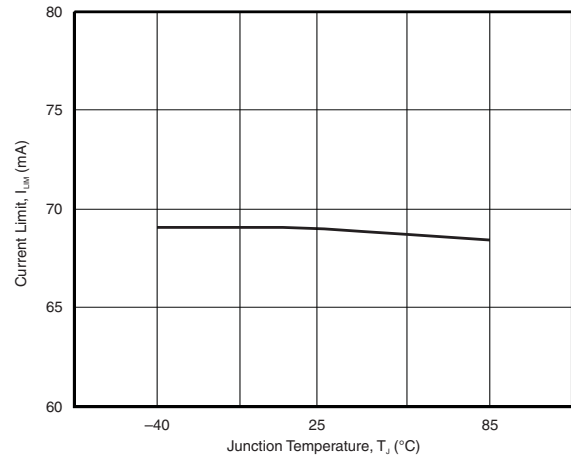

Figure 14.  $I_{LIM}$  vs Temperature (TPS22941, TPS22943)

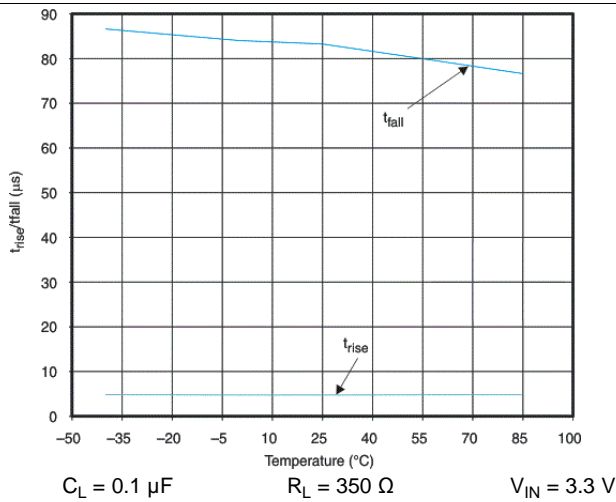

Figure 15.  $t_{rise}/t_{fall}$  vs Temperature

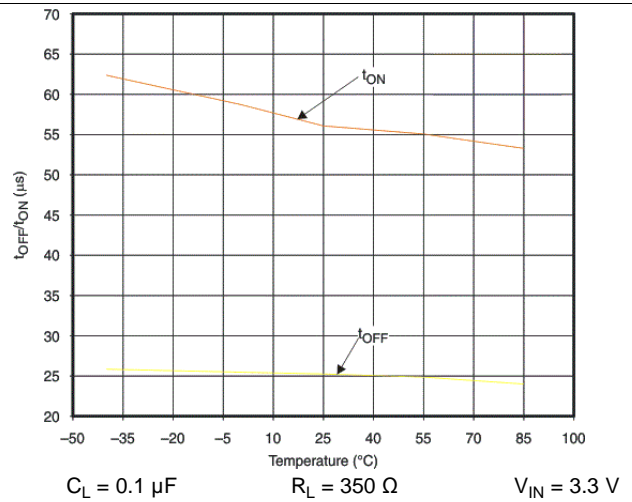

Figure 16.  $t_{ON}/t_{OFF}$  vs Temperature

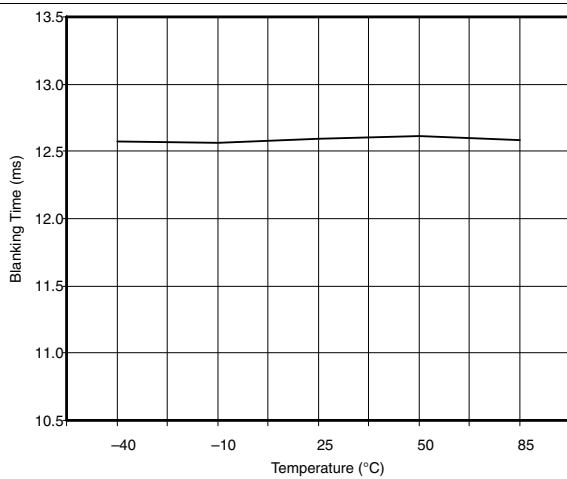

Figure 17.  $t_{BLANK}$  vs Temperature ( $V_{IN} = 3.3 V$ )

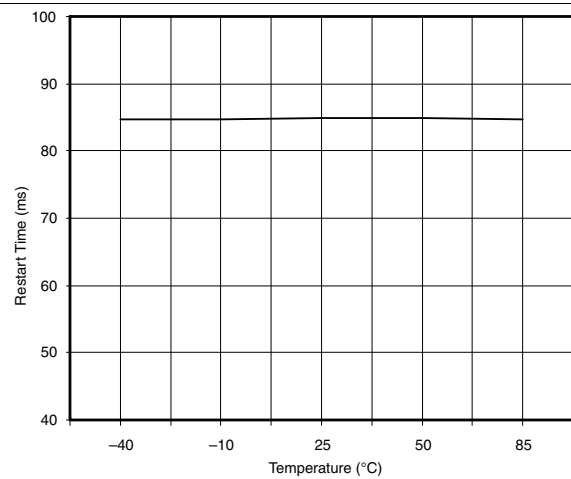

Figure 18.  $t_{RESTART}$  vs Temperature ( $V_{IN} = 3.3 V$ )



## 8 Detailed Description

### 8.1 Overview

The TPS22941/2/3/4/5 load switches are 5.5V, current limited load switches in a SC-70 package. The devices contain a 0.4- $\Omega$  current-limited P-channel MOSFET that can operate over an input voltage range of 1.62 V to 5.5 V.

When the switch current reaches the maximum limit, the TPS22941/2/3/4/5 operates in a constant-current mode to prohibit excessive currents from causing damage. TPS22941/3 has a current limit of 40 mA and TPS22942/4/5 has a current limit of 100 mA.

For the TPS22941/2/5, if the constant current condition still persists after 10ms, these parts shut off the switch and pull the fault signal pin (OC) low. The TPS22941/2/5 have an auto-restart feature that turns the switch on again after 80 ms if the ON pin is still active. A current limit condition on the TPS22943 and on the TPS22944 immediately pull the fault signal pin low (OC pin) and the part remains in the constant-current mode until the switch current falls below the current limit.

### 8.2 Functional Block Diagram

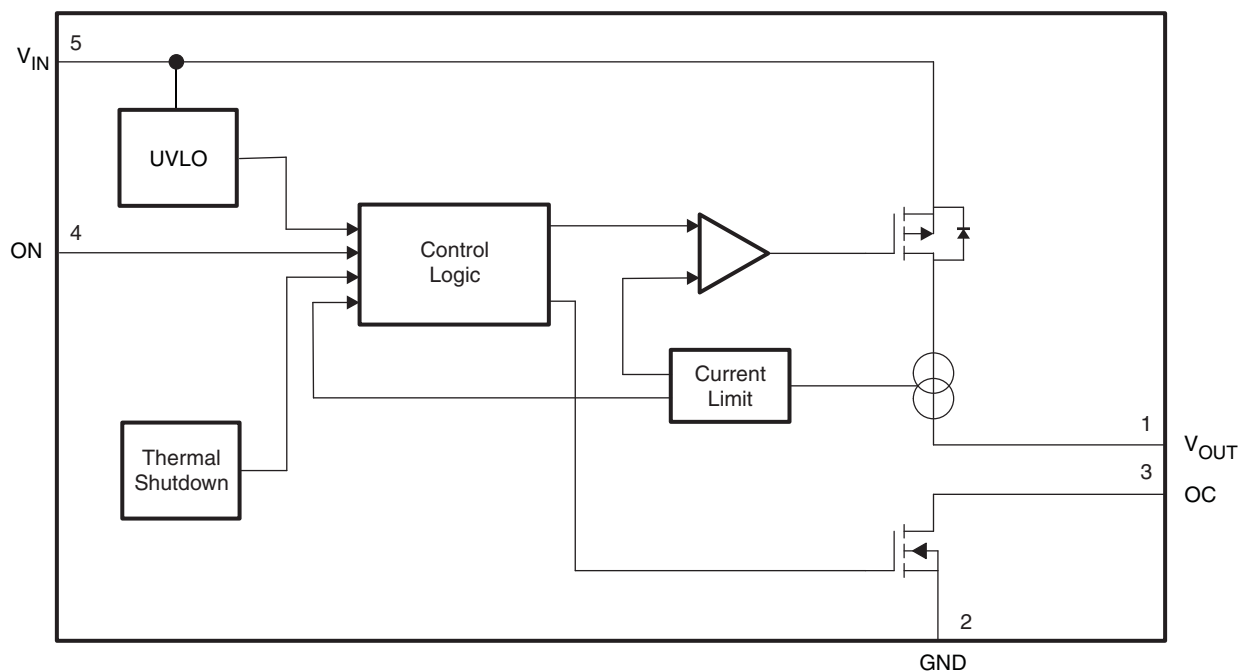

### 8.3 Feature Description

#### 8.3.1 Fault Reporting

When an overcurrent, input undervoltage, or overtemperature condition is detected, OC is set active low to signal the fault mode. OC is an open-drain MOSFET and requires a pullup resistor between  $V_{IN}$  and OC. During shutdown, the pulldown on OC is disabled, reducing current draw from the supply.

#### 8.3.2 Current Limiting

When the switch current reaches the maximum limit, the TPS22921/2/3/4/5 operates in a constant-current mode to prohibit excessive currents from causing damage. TPS22921/3 has a current limit of 40 mA and TPS22922/4/5 has a current limit of 100 mA. A current limit condition immediately pulls the fault signal pin low (OC pin), and the part remains in the constant-current mode until the switch current falls below the current limit.

## Feature Description (continued)

### 8.3.3 Thermal Shutdown

Thermal shutdown protects the part from internally or externally generated excessive temperatures. During an overtemperature condition the switch is turned off. The switch automatically turns on again if the temperature of the die drops below the threshold temperature.

### 8.4 Device Functional Modes

When the ON pin is actively pulled high and no fault conditions are present, the switch will be turned on, connecting VIN to VOUT. When the ON pin is actively pulled low regardless of the fault condition, the switch will be turned off.

In the event that the current limit is exceeded, the device will operate in a constant-current mode and pull the OC pin low until the fault condition is removed. If the condition persists after the current limit blanking time, the device will automatically turn off.

During thermal shutdown conditions, the switch will automatically turn off and will turn back on again if the temperature of the die drops below the threshold temperature.

## 9 Application and Implementation

This section will highlight some of the design considerations when implementing this device in various applications.

### 9.1 Application Information

#### 9.1.1 On/Off Control

The ON pin controls the state of the switch. Activating ON continuously holds the switch in the on state as long as there is no fault. An undervoltage lockout or thermal shutdown event will override the ON pin control and turn off the switch. ON is active high and has a low threshold, making it capable of interfacing with low-voltage signals.

#### 9.1.2 Undervoltage Lockout

The undervoltage lockout turns off the switch if the input voltage drops below the undervoltage lockout threshold. With the ON pin active, the input voltage rising above the undervoltage lockout threshold causes a controlled turn-on of the switch, which limits current overshoots.

#### 9.1.3 Reverse Voltage

If the voltage at the  $V_{OUT}$  pin is larger than the  $V_{IN}$  pin, large currents may flow and can cause permanent damage to the device. TPS22941/2/3/4/5 is designed to control current flow only from  $V_{IN}$  to  $V_{OUT}$ .

#### 9.1.4 Input Capacitor

To limit the voltage drop on the input supply caused by transient in-rush currents when the switch turns on into a discharged load capacitor or a short-circuit, a capacitor needs to be placed between  $V_{IN}$  and GND. A 1- $\mu\text{F}$  ceramic capacitor,  $C_{IN}$ , placed close to the pins is usually sufficient. Higher values of  $C_{IN}$  can be used to further reduce the voltage drop.

#### 9.1.5 Output Capacitor

A 0.1- $\mu\text{F}$  capacitor,  $C_{OUT}$ , should be placed between  $V_{OUT}$  and GND. This capacitor will prevent parasitic board inductances from forcing  $V_{OUT}$  below GND when the switch turns off. For the TPS22941/2/3/4/5, the total output capacitance needs to be kept below a maximum value,  $C_{OUT(MAX)}$ , to prevent the part from registering an over-current condition and turning-off the switch.

Due to the integrated body diode in the PMOS switch, a  $C_{IN}$  greater than  $C_{OUT}$  is highly recommended. A  $C_{OUT}$  greater than  $C_{IN}$  can cause  $V_{OUT}$  to exceed  $V_{IN}$  when the system supply is removed. This could result in current flow through the body diode from  $V_{OUT}$  to  $V_{IN}$ .

### 9.2 Typical Application

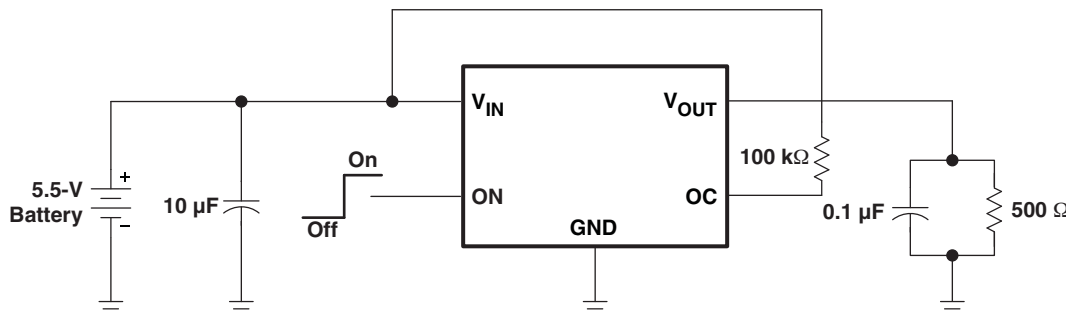

**Figure 19. Typical Application Circuit, Active-High Enabled Device (TPS22943, TPS22944 and TPS22945 Only)**

## Typical Application (continued)

### 9.2.1 Design Requirements

For this design example, use the following as the input parameters:

DESIGN PARAMETER	EXAMPLE VALUE
$V_{IN}$	5.0 V
Load Current	50mA

### 9.2.2 Detailed Design Procedure

To begin the design process, the designer needs to know the following:

- $V_{IN}$  voltage
- Load current

#### 9.2.2.1 $V_{IN}$ to $V_{OUT}$ Voltage Drop

The  $V_{IN}$  to  $V_{OUT}$  voltage drop in the device is determined by the  $R_{ON}$  of the device and the load current. The  $R_{ON}$  of the device depends upon the  $V_{IN}$  condition of the device. Refer to the  $R_{ON}$  specification of the device in the Electrical Characteristics table of this datasheet.

Once the  $R_{ON}$  of the device is determined based upon the  $V_{IN}$  conditions, use [Equation 1](#) to calculate the  $V_{IN}$  to  $V_{OUT}$  voltage drop:

$$\Delta V = I_{LOAD} \times R_{ON}$$

where:

- $\Delta V$  = voltage drop from  $V_{IN}$  to  $V_{OUT}$
  - $I_{LOAD}$  = load current
  - $R_{ON}$  = ON-resistance of the device for a specific  $V_{IN}$
- (1)

#### 9.2.2.2 Maximum Output Capacitance

When designing this device, it is important to ensure the inrush current of the output capacitance does not cause the device to exceed the current limiting time beyond the blanking time. The maximum output capacitance can be determined from [Equation 2](#) :

$$C_{OUT} = \frac{I_{LM(MAX)} \times t_{BLANK(MIN)}}{V_{IN}}$$

where:

- $C_{OUT}$  = output capacitance
  - $I_{LM(MAX)}$  = maximum current limit
  - $t_{BLANK(MIN)}$  = minimum blanking time
  - $V_{IN}$  = input voltage
- (2)

**9.2.2.3 Power Dissipation**

During normal operation as a switch, the power dissipation is small and has little effect on the operating temperature of the part. The parts with the higher current limits will dissipate the most power and that will only be,

$$P_D = (I_{LIM})^2 \times r_{ON} \tag{3}$$

If the part goes into current limit the maximum power dissipation will occur when the output is shorted to ground. For TPS22941/2/5, the power dissipation scales by the auto-restart time ( $t_{RESTART}$ ) and the overcurrent blanking time ( $t_{BLANK}$ ) so that the maximum power dissipated is:

$$P_{D(MAX)} = \left( \frac{t_{BLANK}}{t_{RESTART} + t_{BLANK}} \right) \times V_{IN(MAX)} \times I_{LIM(MAX)} \tag{4}$$

When using the TPS22943 and TPS22944, a short on the output causes the part to operate in a constant current state, dissipating a worst-case power as calculated above until the thermal shutdown activates. It then cycles in and out of thermal shutdown so long as the ON pin is active and the short is present.

**9.2.2.4 Application Curves**

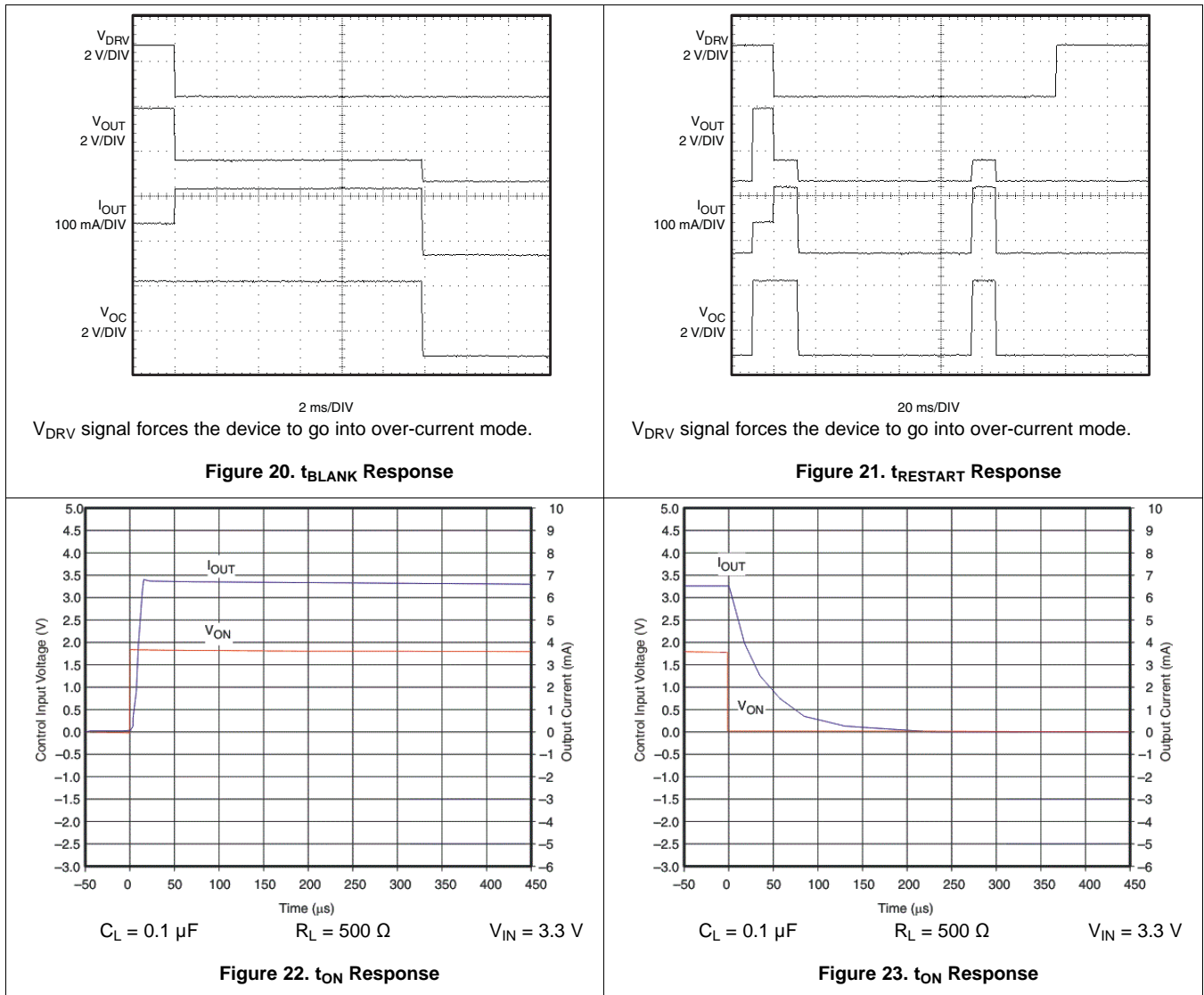

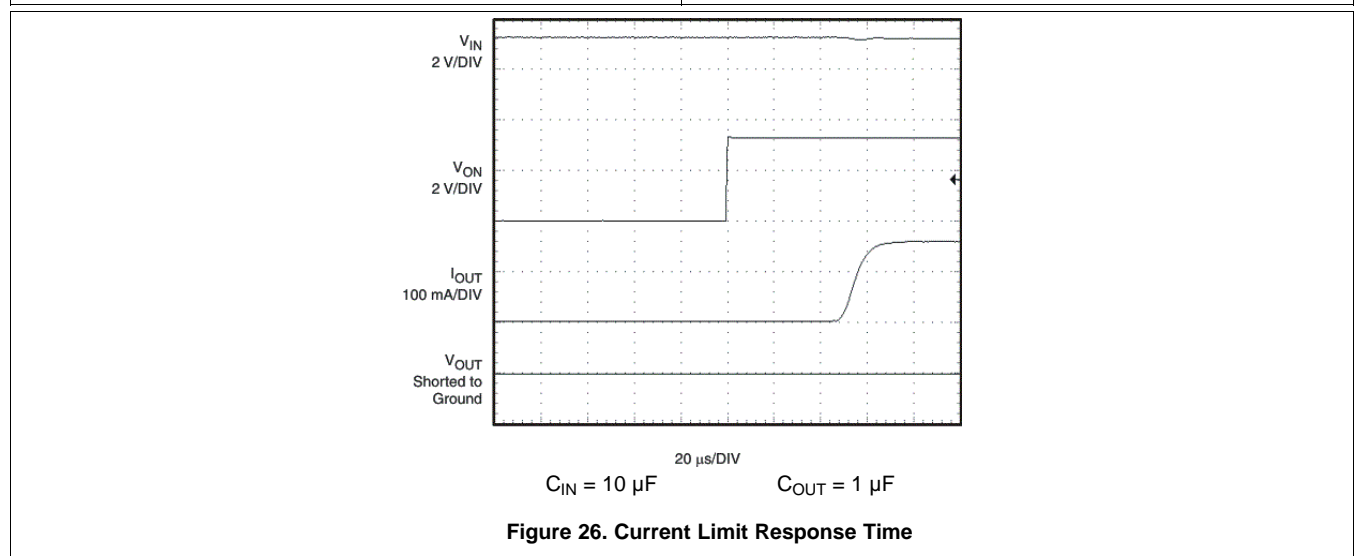
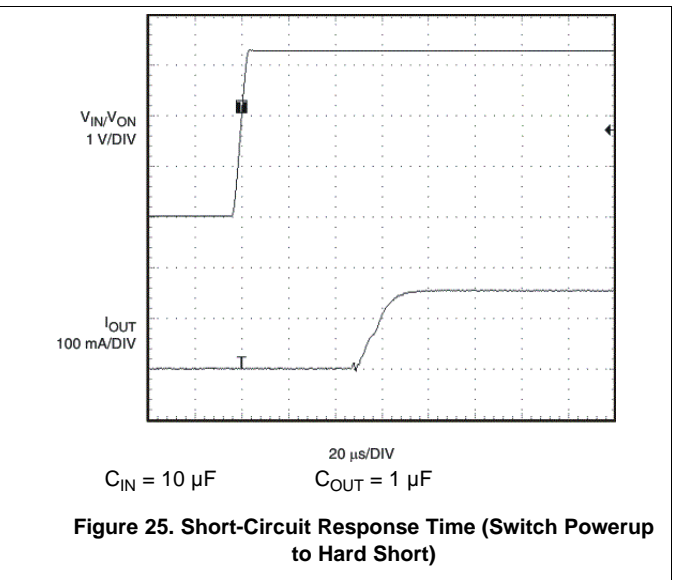
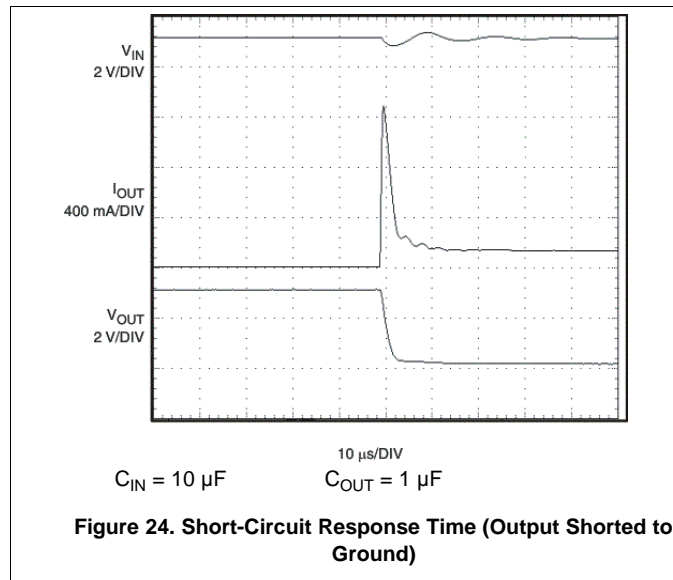

## 10 Power Supply Recommendations

The device is designed to operate from a  $V_{IN}$  range of 1.62-V to 5.5-V. This supply must be well regulated and placed as close to the device terminal as possible with the recommended 1- $\mu$ F bypass capacitor. If the supply is located more than a few inches from the device terminals, additional bulk capacitance may be required in addition to the ceramic bypass capacitors. If additional bulk capacitance is required, an electrolytic, tantalum, or ceramic capacitor of 10- $\mu$ F may be sufficient.

## 11 Layout

### 11.1 Layout Guidelines

- For best performance, all traces should be as short as possible.
- To be most effective, the input and output capacitors should be placed close to the device to minimize the effects that parasitic trace inductances may have on normal and short-circuit operation.
- The  $V_{IN}$  terminal should be bypassed to ground with low ESR ceramic bypass capacitors. The typical recommended bypass capacitance is 1- $\mu$ F ceramic with X5R or X7R dielectric. This capacitor should be placed as close to the device terminals as possible.
- The  $V_{OUT}$  terminal should be bypassed to ground with low ESR ceramic bypass capacitors. The typical recommended bypass capacitance is one-tenth of the  $V_{IN}$  bypass capacitor of X5R or X7R dielectric. This capacitor should be placed as close to the device terminals as possible.
- Using wide traces for  $V_{IN}$ ,  $V_{OUT}$ , and GND will help minimize parasitic electrical effects along with minimizing the case to ambient thermal impedance.

### 11.2 Layout Example

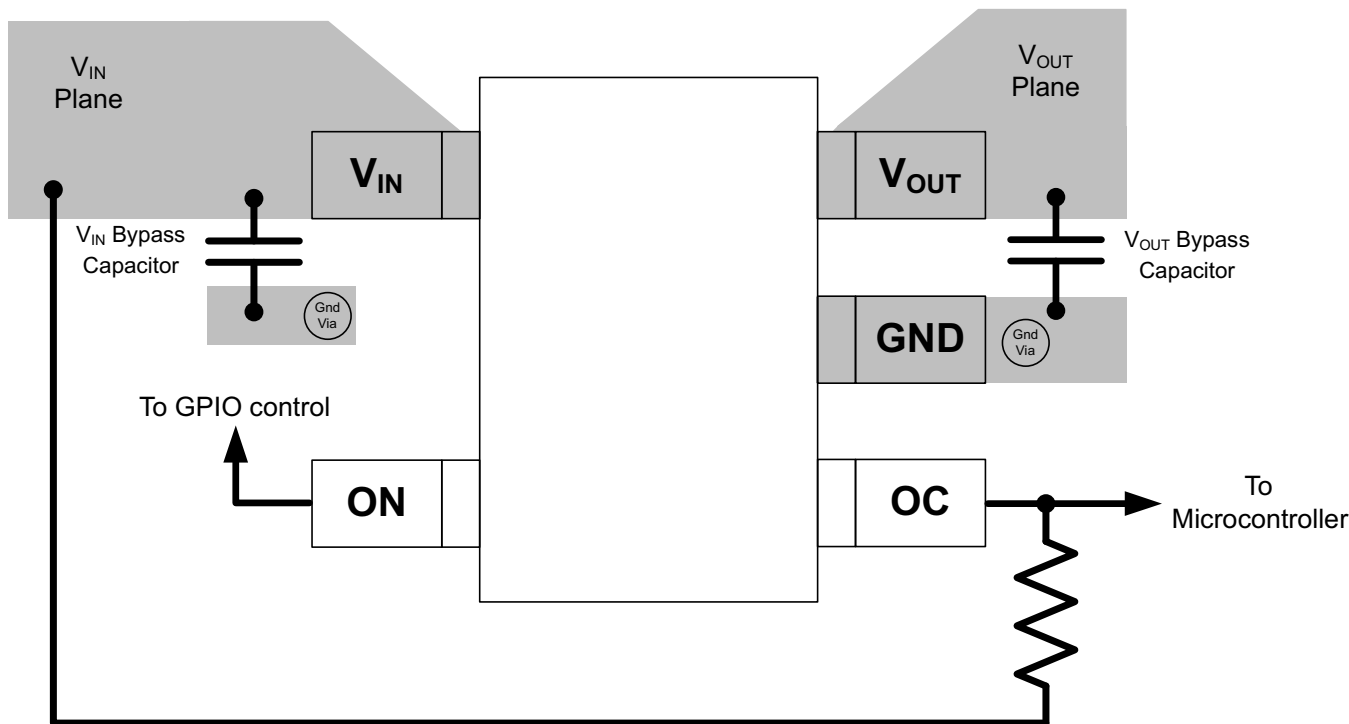

### 11.3 Thermal Considerations

The maximum junction temperature will be internally limited by the thermal shutdown ( $T_{SD}$ ). To calculate the maximum allowable dissipation,  $P_{D(MAX)}$  for a given ambient temperature, use [Equation 5](#).

$$P_{D(MAX)} = \frac{T_{SD} - T_A}{\theta_{JA}}$$

where:

- $P_{D(MAX)}$  = maximum allowable power dissipation
- $T_{SD}$  = thermal shutdown threshold (140 °C typical)
- $T_A$  = ambient temperature of the device
- $\theta_{JA}$  = junction to air thermal impedance. See the section. This parameter is highly dependent upon board layout.

(5)



## 12 Device and Documentation Support

### 12.1 Related Links

The table below lists quick access links. Categories include technical documents, support and community resources, tools and software, and quick access to sample or buy.

**Table 1. Related Links**

PARTS	PRODUCT FOLDER	SAMPLE & BUY	TECHNICAL DOCUMENTS	TOOLS & SOFTWARE	SUPPORT & COMMUNITY
TPS22941	<a href="#">Click here</a>	<a href="#">Click here</a>	<a href="#">Click here</a>	<a href="#">Click here</a>	<a href="#">Click here</a>
TPS22942	<a href="#">Click here</a>	<a href="#">Click here</a>	<a href="#">Click here</a>	<a href="#">Click here</a>	<a href="#">Click here</a>
TPS22943	<a href="#">Click here</a>	<a href="#">Click here</a>	<a href="#">Click here</a>	<a href="#">Click here</a>	<a href="#">Click here</a>
TPS22944	<a href="#">Click here</a>	<a href="#">Click here</a>	<a href="#">Click here</a>	<a href="#">Click here</a>	<a href="#">Click here</a>
TPS22945	<a href="#">Click here</a>	<a href="#">Click here</a>	<a href="#">Click here</a>	<a href="#">Click here</a>	<a href="#">Click here</a>

### 12.2 Trademarks

All trademarks are the property of their respective owners.

### 12.3 Electrostatic Discharge Caution



These devices have limited built-in ESD protection. The leads should be shorted together or the device placed in conductive foam during storage or handling to prevent electrostatic damage to the MOS gates.

### 12.4 Glossary

[SLYZ022](#) — *TI Glossary*.

This glossary lists and explains terms, acronyms, and definitions.

## 13 Mechanical, Packaging, and Orderable Information

The following pages include mechanical, packaging, and orderable information. This information is the most current data available for the designated devices. This data is subject to change without notice and revision of this document. For browser-based versions of this data sheet, refer to the left-hand navigation.

## PACKAGING INFORMATION

Orderable Device	Status (1)	Package Type	Package Drawing	Pins	Package Qty	Eco Plan (2)	Lead finish/ Ball material (6)	MSL Peak Temp (3)	Op Temp (°C)	Device Marking (4/5)	Samples
TPS22941DCKR	ACTIVE	SC70	DCK	5	3000	RoHS & Green	NIPDAU	Level-1-260C-UNLIM	-40 to 85	4AN	<a href="#">Samples</a>
TPS22942DCKR	ACTIVE	SC70	DCK	5	3000	RoHS & Green	NIPDAU	Level-1-260C-UNLIM	-40 to 85	(4BJ, 4BN)	<a href="#">Samples</a>
TPS22942DCKRG4	ACTIVE	SC70	DCK	5	3000	RoHS & Green	NIPDAU	Level-1-260C-UNLIM	-40 to 85	(4BJ, 4BN)	<a href="#">Samples</a>
TPS22943DCKR	ACTIVE	SC70	DCK	5	3000	RoHS & Green	NIPDAU	Level-1-260C-UNLIM	-40 to 85	4CN	<a href="#">Samples</a>
TPS22944DCKR	ACTIVE	SC70	DCK	5	3000	RoHS & Green	NIPDAU	Level-1-260C-UNLIM	-40 to 85	4DN	<a href="#">Samples</a>
TPS22945DCKR	ACTIVE	SC70	DCK	5	3000	RoHS & Green	NIPDAU	Level-1-260C-UNLIM	-40 to 85	(4EJ, 4EN)	<a href="#">Samples</a>
TPS22945DCKRG4	ACTIVE	SC70	DCK	5	3000	RoHS & Green	NIPDAU	Level-1-260C-UNLIM	-40 to 85	(4EJ, 4EN)	<a href="#">Samples</a>

(1) The marketing status values are defined as follows:

**ACTIVE:** Product device recommended for new designs.

**LIFEBUY:** TI has announced that the device will be discontinued, and a lifetime-buy period is in effect.

**NRND:** Not recommended for new designs. Device is in production to support existing customers, but TI does not recommend using this part in a new design.

**PREVIEW:** Device has been announced but is not in production. Samples may or may not be available.

**OBSOLETE:** TI has discontinued the production of the device.

(2) **RoHS:** TI defines "RoHS" to mean semiconductor products that are compliant with the current EU RoHS requirements for all 10 RoHS substances, including the requirement that RoHS substance do not exceed 0.1% by weight in homogeneous materials. Where designed to be soldered at high temperatures, "RoHS" products are suitable for use in specified lead-free processes. TI may reference these types of products as "Pb-Free".

**RoHS Exempt:** TI defines "RoHS Exempt" to mean products that contain lead but are compliant with EU RoHS pursuant to a specific EU RoHS exemption.

**Green:** TI defines "Green" to mean the content of Chlorine (Cl) and Bromine (Br) based flame retardants meet JS709B low halogen requirements of <=1000ppm threshold. Antimony trioxide based flame retardants must also meet the <=1000ppm threshold requirement.

(3) MSL, Peak Temp. - The Moisture Sensitivity Level rating according to the JEDEC industry standard classifications, and peak solder temperature.

(4) There may be additional marking, which relates to the logo, the lot trace code information, or the environmental category on the device.

(5) Multiple Device Markings will be inside parentheses. Only one Device Marking contained in parentheses and separated by a "~" will appear on a device. If a line is indented then it is a continuation of the previous line and the two combined represent the entire Device Marking for that device.

<sup>(6)</sup> Lead finish/Ball material - Orderable Devices may have multiple material finish options. Finish options are separated by a vertical ruled line. Lead finish/Ball material values may wrap to two lines if the finish value exceeds the maximum column width.

**Important Information and Disclaimer:**The information provided on this page represents TI's knowledge and belief as of the date that it is provided. TI bases its knowledge and belief on information provided by third parties, and makes no representation or warranty as to the accuracy of such information. Efforts are underway to better integrate information from third parties. TI has taken and continues to take reasonable steps to provide representative and accurate information but may not have conducted destructive testing or chemical analysis on incoming materials and chemicals. TI and TI suppliers consider certain information to be proprietary, and thus CAS numbers and other limited information may not be available for release.

In no event shall TI's liability arising out of such information exceed the total purchase price of the TI part(s) at issue in this document sold by TI to Customer on an annual basis.

**TAPE AND REEL INFORMATION**

**QUADRANT ASSIGNMENTS FOR PIN 1 ORIENTATION IN TAPE**

\*All dimensions are nominal

Device	Package Type	Package Drawing	Pins	SPQ	Reel Diameter (mm)	Reel Width W1 (mm)	A0 (mm)	B0 (mm)	K0 (mm)	P1 (mm)	W (mm)	Pin1 Quadrant
TPS22941DCKR	SC70	DCK	5	3000	180.0	9.2	2.3	2.55	1.2	4.0	8.0	Q3
TPS22942DCKR	SC70	DCK	5	3000	179.0	8.4	2.2	2.5	1.2	4.0	8.0	Q3
TPS22942DCKR	SC70	DCK	5	3000	180.0	9.2	2.3	2.55	1.2	4.0	8.0	Q3
TPS22943DCKR	SC70	DCK	5	3000	180.0	9.2	2.3	2.55	1.2	4.0	8.0	Q3
TPS22944DCKR	SC70	DCK	5	3000	180.0	9.2	2.3	2.55	1.2	4.0	8.0	Q3
TPS22945DCKR	SC70	DCK	5	3000	180.0	9.2	2.3	2.55	1.2	4.0	8.0	Q3
TPS22945DCKR	SC70	DCK	5	3000	179.0	8.4	2.2	2.5	1.2	4.0	8.0	Q3

**TAPE AND REEL BOX DIMENSIONS**

\*All dimensions are nominal

Device	Package Type	Package Drawing	Pins	SPQ	Length (mm)	Width (mm)	Height (mm)
TPS22941DCKR	SC70	DCK	5	3000	205.0	200.0	33.0
TPS22942DCKR	SC70	DCK	5	3000	203.0	203.0	35.0
TPS22942DCKR	SC70	DCK	5	3000	205.0	200.0	33.0
TPS22943DCKR	SC70	DCK	5	3000	205.0	200.0	33.0
TPS22944DCKR	SC70	DCK	5	3000	205.0	200.0	33.0
TPS22945DCKR	SC70	DCK	5	3000	205.0	200.0	33.0
TPS22945DCKR	SC70	DCK	5	3000	200.0	183.0	25.0

DCK (R-PDSO-G5)

PLASTIC SMALL-OUTLINE PACKAGE



- NOTES:
- A. All linear dimensions are in millimeters.
  - B. This drawing is subject to change without notice.
  - C. Body dimensions do not include mold flash or protrusion. Mold flash and protrusion shall not exceed 0.15 per side.
  - D. Falls within JEDEC MO-203 variation AA.

DCK (R-PDSO-G5)

PLASTIC SMALL OUTLINE



- NOTES:
- All linear dimensions are in millimeters.
  - This drawing is subject to change without notice.
  - Customers should place a note on the circuit board fabrication drawing not to alter the center solder mask defined pad.
  - Publication IPC-7351 is recommended for alternate designs.
  - Laser cutting apertures with trapezoidal walls and also rounding corners will offer better paste release. Customers should contact their board assembly site for stencil design recommendations. Example stencil design based on a 50% volumetric metal load solder paste. Refer to IPC-7525 for other stencil recommendations.

## IMPORTANT NOTICE AND DISCLAIMER

TI PROVIDES TECHNICAL AND RELIABILITY DATA (INCLUDING DATASHEETS), DESIGN RESOURCES (INCLUDING REFERENCE DESIGNS), APPLICATION OR OTHER DESIGN ADVICE, WEB TOOLS, SAFETY INFORMATION, AND OTHER RESOURCES "AS IS" AND WITH ALL FAULTS, AND DISCLAIMS ALL WARRANTIES, EXPRESS AND IMPLIED, INCLUDING WITHOUT LIMITATION ANY IMPLIED WARRANTIES OF MERCHANTABILITY, FITNESS FOR A PARTICULAR PURPOSE OR NON-INFRINGEMENT OF THIRD PARTY INTELLECTUAL PROPERTY RIGHTS.

These resources are intended for skilled developers designing with TI products. You are solely responsible for (1) selecting the appropriate TI products for your application, (2) designing, validating and testing your application, and (3) ensuring your application meets applicable standards, and any other safety, security, or other requirements. These resources are subject to change without notice. TI grants you permission to use these resources only for development of an application that uses the TI products described in the resource. Other reproduction and display of these resources is prohibited. No license is granted to any other TI intellectual property right or to any third party intellectual property right. TI disclaims responsibility for, and you will fully indemnify TI and its representatives against, any claims, damages, costs, losses, and liabilities arising out of your use of these resources.

TI's products are provided subject to TI's Terms of Sale (<https://www.ti.com/legal/termsofsale.html>) or other applicable terms available either on [ti.com](https://www.ti.com) or provided in conjunction with such TI products. TI's provision of these resources does not expand or otherwise alter TI's applicable warranties or warranty disclaimers for TI products.

Mailing Address: Texas Instruments, Post Office Box 655303, Dallas, Texas 75265  
Copyright © 2021, Texas Instruments Incorporated