

# OptoHiT™ Series, High-Temperature Phototransistor Optocoupler in Half-Pitch Mini-Flat 4-Pin Package

## FODM8801A, FODM8801B, FODM8801C

### Description

In the OptoHiT series, the FODM8801 is a first-of-kind phototransistor, utilizing onsemi's leading-edge proprietary process technology to achieve high operating temperature characteristics, up to 125°C. The opto-coupler consists of an aluminum gallium arsenide (AlGaAs) infrared light-emitting diode (LED) optically coupled to a phototransistor, available in a compact half-pitch, mini-flat, 4-pin package. It delivers high current transfer ratio at very low input current. The input-output isolation voltage,  $V_{ISO}$ , is rated at 3750  $V_{AC_{RMS}}$ .

### Features

- Utilizing Proprietary Process Technology to Achieve High Operating Temperature: Up to 125°C
- Guaranteed Current Transfer Ratio (CTR) Specifications Across Full Temperature Range
  - ◆ Excellent CTR Linearity at High-Temperature
  - ◆ CTR at Very Low Input Current,  $I_F$
- High Isolation Voltage Regulated by Safety Agency: C-UL / UL1577, 3750  $V_{AC_{RMS}}$  for 1 Minute and DIN EN/IEC60747-5-5
- Compact Half-Pitch, Mini-Flat, 4-Pin Package (1.27 mm Lead Pitch, 2.4 mm Maximum Standoff Height)
- >5 mm Creepage and Clearance Distance
- Applicable to Infrared Ray Reflow, 245°C
- These are Pb-Free Devices

### Applications

- Primarily Suited for DC-DC Converters
- Ground-Loop Isolation, Signal-Noise Isolation
- Communications – Adapters, Chargers
- Consumer – Appliances, Set-Top Boxes
- Industrial – Power Supplies, Motor Control, Programmable Logic Control

### HALF-PITCH MINI-FLAT

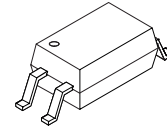

MFP4 2.5 x 4.4, 1.27P  
 CASE 100AL

### MARKING DIAGRAM

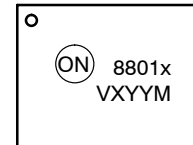

- 8801x = Specific Device Code (x = A, B, C)
- V = DIN EN/IEC60747-5-5 Option (only appears on component ordered with this option)
- X = One-Digit Year Code
- YY = Digit Work Week
- M = Assembly Package Code

### PIN CONNECTIONS

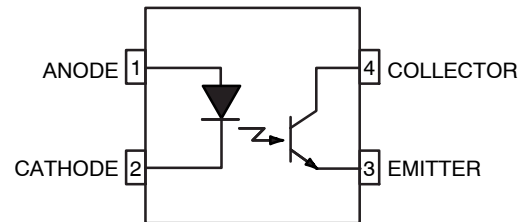

### ORDERING INFORMATION

See detailed ordering and shipping information on page 9 of this data sheet.

# FODM8801A, FODM8801B, FODM8801C

**SAFETY AND INSULATION RATINGS** (As per DIN EN/IEC 60747-5-5, this optocoupler is suitable for “safe electrical insulation” only within the safety limit data. Compliance with the safety ratings shall be ensured by means of protective circuits.)

Parameter		Characteristics
Installation Classifications per DIN VDE 0110/1.89 Table 1, For Rated Mains Voltage	<150 V <sub>RMS</sub>	I-IV
	<300 V <sub>RMS</sub>	I-III
Climatic Classification		40/125/21
Pollution Degree (DIN VDE 0110/1.89)		2
Comparative Tracking Index		175

Symbol	Parameter	Value	Unit
V <sub>PR</sub>	Input-to-Output Test Voltage, Method A, V <sub>IORM</sub> × 1.6 = V <sub>PR</sub> , Type and Sample Test with t <sub>m</sub> = 10 s, Partial Discharge < 5 pC	848	V <sub>peak</sub>
	Input-to-Output Test Voltage, Method B, V <sub>IORM</sub> × 1.875 = V <sub>PR</sub> , 100% Production Test with t <sub>m</sub> = 1 s, Partial Discharge < 5 pC	1060	V <sub>peak</sub>
V <sub>IORM</sub>	Maximum Working Insulation Voltage	565	V <sub>peak</sub>
V <sub>IOTM</sub>	Highest Allowable Over-Voltage	6000	V <sub>peak</sub>
	External Creepage	≥5	mm
	External Clearance	≥5	mm
DTI	Distance Through Insulation (Insulation Thickness)	≥0.5	mm
T <sub>S</sub>	Case Temperature (Note 1)	150	°C
I <sub>S,INPUT</sub>	Input Current (Note 1)	200	mA
P <sub>S,OUTPUT</sub>	Output Power (Note 1)	300	mW
R <sub>IO</sub>	Insulation Resistance at T <sub>S</sub> , V <sub>IO</sub> = 500 V (Note 1)	>10 <sup>9</sup>	Ω

1. Safety limit values – maximum values allowed in the event of a failure.

## ABSOLUTE MAXIMUM RATINGS (T<sub>A</sub> = 25°C, unless otherwise noted)

Symbol	Parameter	Value	Unit
<b>TOTAL PACKAGE</b>			
T <sub>STG</sub>	Storage Temperature	-40 to +150	°C
T <sub>OPR</sub>	Operating Temperature	-40 to +125	°C
T <sub>J</sub>	Junction Temperature	-40 to +140	°C
T <sub>SOL</sub>	Lead Solder Temperature	245 for 10 s	°C
<b>EMITTER</b>			
I <sub>F(average)</sub>	Continuous Forward Current	20	mA
V <sub>R</sub>	Reverse Input Voltage	6	V
P <sub>DLED</sub>	Power Dissipation (Note 2, 4)	40	mW
<b>DETECTOR</b>			
I <sub>C(average)</sub>	Continuous Collector Current	30	mA
V <sub>CEO</sub>	Collector-Emitter Voltage	75	V
V <sub>ECO</sub>	Emitter-Collector Voltage	7	V
P <sub>DC</sub>	Collector Power Dissipation (Note 3, 4)	150	mW

Stresses exceeding those listed in the Maximum Ratings table may damage the device. If any of these limits are exceeded, device functionality should not be assumed, damage may occur and reliability may be affected.

2. Derate linearly from 73°C at a rate of 0.24 mW/°C.

3. Derate linearly from 73°C at a rate of 2.23 mW/°C.

4. Functional operation under these conditions is not implied. Permanent damage may occur if the device is subjected to conditions outside these ratings.

# FODM8801A, FODM8801B, FODM8801C

## RECOMMENDED OPERATING CONDITIONS

Symbol	Parameter	Value	Unit
$T_A$	Operating Temperature	-40 to +125	°C
$V_{FL(OFF)}$	Input Low Voltage	-5.0 to +0.8	V
$I_{FH}$	Input High Forward Current	1 to 10	mA

Functional operation above the stresses listed in the Recommended Operating Ranges is not implied. Extended exposure to stresses beyond the Recommended Operating Ranges limits may affect device reliability.

## ISOLATION CHARACTERISTICS

Symbol	Parameter	Conditions	Min	Typ	Max	Unit
$V_{ISO}$	Input-Output Isolation Voltage	$f = 60 \text{ Hz}$ , $t = 1 \text{ min.}$ , $I_{I-O} \leq 10 \mu\text{A}$ (Note 5, 6)	3,750	-	-	VAC <sub>RMS</sub>
$R_{ISO}$	Isolation Resistance	$V_{I-O} = 500 \text{ V}$ (Note 5)	$10^{12}$	-	-	$\Omega$
$C_{ISO}$	Isolation Capacitance	$f = 1 \text{ MHz}$	-	0.3	0.5	pF

5. Device is considered a two-terminal device: pins 1 and 2 are shorted together and pins 3 and 4 are shorted together.

6. 3,750 VAC<sub>RMS</sub> for 1 minute is equivalent to 4,500 VAC<sub>RMS</sub> for 1 second.

## ELECTRICAL CHARACTERISTICS Apply over all recommended conditions ( $T_A = -40^\circ\text{C}$ to $+125^\circ\text{C}$ unless otherwise specified.)

All typical values are measured at  $T_A = 25^\circ\text{C}$

Symbol	Parameter	Conditions	Min	Typ	Max	Unit
--------	-----------	------------	-----	-----	-----	------

### EMITTER

$V_F$	Forward Voltage	$I_F = 1 \text{ mA}$	1.00	1.35	1.80	V
$\Delta V_F / \Delta T_A$	Forward-Voltage Coefficient	$I_F = 1 \text{ mA}$	-	-1.6	-	mV/°C
$I_R$	Reverse Current	$V_R = 6 \text{ V}$	-	-	10	$\mu\text{A}$
$C_T$	Terminal Capacitance	$V = 0 \text{ V}$ , $f = 1 \text{ MHz}$	-	30	-	pF

### DETECTOR

$BV_{CEO}$	Collector-Emitter Breakdown Voltage	$I_C = 0.5 \text{ mA}$ , $I_F = 0 \text{ mA}$	75	130	-	V
$BV_{ECO}$	Emitter-Collector Breakdown Voltage	$I_E = 100 \mu\text{A}$ , $I_F = 0 \text{ mA}$	7	12	-	V
$I_{CEO}$	Collector Dark Current	$V_{CE} = 75 \text{ V}$ , $I_F = 0 \text{ mA}$ , $T_A = 25^\circ\text{C}$	-	-	100	nA
		$V_{CE} = 50 \text{ V}$ , $I_F = 0 \text{ mA}$	-	-	50	$\mu\text{A}$
		$V_{CE} = 5 \text{ V}$ , $I_F = 0 \text{ mA}$	-	-	30	$\mu\text{A}$
$C_{CE}$	Capacitance	$V_{CE} = 0 \text{ V}$ , $f = 1 \text{ MHz}$	-	8	-	pF

Product parametric performance is indicated in the Electrical Characteristics for the listed test conditions, unless otherwise noted. Product performance may not be indicated by the Electrical Characteristics if operated under different conditions.

# FODM8801A, FODM8801B, FODM8801C

**TRANSFER CHARACTERISTICS** Apply over all recommended conditions ( $T_A = -40^\circ\text{C}$  to  $+125^\circ\text{C}$  unless otherwise specified.)  
All typical values are measured at  $T_A = 25^\circ\text{C}$

Symbol	Parameter	Device	Conditions	Min	Typ	Max	Unit
CTR <sub>CE</sub>	Current Transfer Ratio (Collector-Emitter)	FODM8801A	I <sub>F</sub> = 1.0 mA, V <sub>CE</sub> = 5 V @ T <sub>A</sub> = 25°C	80	120	160	%
			I <sub>F</sub> = 1.0 mA, V <sub>CE</sub> = 5 V	35	120	230	
			I <sub>F</sub> = 1.6 mA, V <sub>CE</sub> = 5 V	40	125	–	
			I <sub>F</sub> = 3.0 mA, V <sub>CE</sub> = 5 V	45	138	–	
		FODM8801B	I <sub>F</sub> = 1.0 mA, V <sub>CE</sub> = 5 V @ T <sub>A</sub> = 25°C	130	195	260	
			I <sub>F</sub> = 1.0 mA, V <sub>CE</sub> = 5 V	65	195	360	
			I <sub>F</sub> = 1.6 mA, V <sub>CE</sub> = 5 V	70	202	–	
			I <sub>F</sub> = 3.0 mA, V <sub>CE</sub> = 5 V	75	215	–	
		FODM8801C	I <sub>F</sub> = 1.0 mA, V <sub>CE</sub> = 5 V @ T <sub>A</sub> = 25°C	200	300	400	
			I <sub>F</sub> = 1.0 mA, V <sub>CE</sub> = 5 V	100	300	560	
			I <sub>F</sub> = 1.6 mA, V <sub>CE</sub> = 5 V	110	312	–	
			I <sub>F</sub> = 3.0 mA, V <sub>CE</sub> = 5 V	115	330	–	
CTR <sub>CE(SAT)</sub>	Saturated Current Transfer Ratio (Collector-Emitter)	FODM8801A	I <sub>F</sub> = 1.0 mA, V <sub>CE</sub> = 0.4 V @ T <sub>A</sub> = 25°C	65	108	150	%
			I <sub>F</sub> = 1.0 mA, V <sub>CE</sub> = 0.4 V	30	108	–	
			I <sub>F</sub> = 1.6 mA, V <sub>CE</sub> = 0.4 V	25	104	–	
			I <sub>F</sub> = 3.0 mA, V <sub>CE</sub> = 0.4 V	20	92	–	
		FODM8801B	I <sub>F</sub> = 1.0 mA, V <sub>CE</sub> = 0.4 V @ T <sub>A</sub> = 25°C	90	168	245	
			I <sub>F</sub> = 1.0 mA, V <sub>CE</sub> = 0.4 V	45	168	–	
			I <sub>F</sub> = 1.6 mA, V <sub>CE</sub> = 0.4 V	40	155	–	
			I <sub>F</sub> = 3.0 mA, V <sub>CE</sub> = 0.4 V	35	132	–	
		FODM8801C	I <sub>F</sub> = 1.0 mA, V <sub>CE</sub> = 0.4 V @ T <sub>A</sub> = 25°C	140	238	380	
			I <sub>F</sub> = 1.0 mA, V <sub>CE</sub> = 0.4 V	75	238	–	
			I <sub>F</sub> = 1.6 mA, V <sub>CE</sub> = 0.4 V	65	215	–	
			I <sub>F</sub> = 3.0 mA, V <sub>CE</sub> = 0.4 V	55	177	–	
V <sub>CE(SAT)</sub>	Saturation Voltage	FODM8801A	I <sub>F</sub> = 1.0 mA, I <sub>C</sub> = 0.3 mA	–	0.17	0.40	V
			I <sub>F</sub> = 1.6 mA, I <sub>C</sub> = 0.4 mA	–	0.16	0.40	
			I <sub>F</sub> = 3.0 mA, I <sub>C</sub> = 0.6 mA	–	0.15	0.40	
		FODM8801B	I <sub>F</sub> = 1.0 mA, I <sub>C</sub> = 0.45 mA	–	0.17	0.40	
			I <sub>F</sub> = 1.6 mA, I <sub>C</sub> = 0.6 mA	–	0.16	0.40	
			I <sub>F</sub> = 3.0 mA, I <sub>C</sub> = 1.0 mA	–	0.16	0.40	
		FODM8801C	I <sub>F</sub> = 1.0 mA, I <sub>C</sub> = 0.75 mA	–	0.18	0.40	
			I <sub>F</sub> = 1.6 mA, I <sub>C</sub> = 1.0 mA	–	0.17	0.40	
			I <sub>F</sub> = 3.0 mA, I <sub>C</sub> = 1.6 mA	–	0.17	0.40	

## FODM8801A, FODM8801B, FODM8801C

**SWITCHING CHARACTERISTICS** Apply over all recommended conditions ( $T_A = -40^\circ\text{C}$  to  $+125^\circ\text{C}$  unless otherwise specified). All typical values are measured at  $T_A = 25^\circ\text{C}$

Symbol	Parameter	Device	Conditions	Min	Typ	Max	Unit
$t_{ON}$	Turn-On Time	All Devices	$I_F = 1.6 \text{ mA}$ , $V_{CC} = 5 \text{ V}$ , $R_L = 0.75 \text{ k}\Omega$	1	6	20	$\mu\text{s}$
			$I_F = 1.6 \text{ mA}$ , $V_{CC} = 5 \text{ V}$ , $R_L = 4.7 \text{ k}\Omega$	–	6	–	
$t_{OFF}$	Turn-Off Time	All Devices	$I_F = 1.6 \text{ mA}$ , $V_{CC} = 5 \text{ V}$ , $R_L = 0.75 \text{ k}\Omega$	1	6	20	$\mu\text{s}$
			$I_F = 1.6 \text{ mA}$ , $V_{CC} = 5 \text{ V}$ , $R_L = 4.7 \text{ k}\Omega$	–	40	–	
$t_R$	Output Rise Time (10% to 90%)	All Devices	$I_F = 1.6 \text{ mA}$ , $V_{CC} = 5 \text{ V}$ , $R_L = 0.75 \text{ k}\Omega$	–	5	–	$\mu\text{s}$
$t_F$	Output Fall Time (90% to 10%)	All Devices	$I_F = 1.6 \text{ mA}$ , $V_{CC} = 5 \text{ V}$ , $R_L = 0.75 \text{ k}\Omega$	–	5.5	–	$\mu\text{s}$
$CM_H$	Common-Mode Rejection Voltage (Transient Immunity) – Output High	All Devices	$T_A = 25^\circ\text{C}$ , $I_F = 0 \text{ mA}$ , $V_O > 2.0 \text{ V}$ , $R_L = 4.7 \text{ k}\Omega$ , $V_{CM} = 1000 \text{ V}$ (Note 7), Figure 14	–	20	–	$\text{kV}/\mu\text{s}$
$CM_L$	Common-Mode Rejection Voltage (Transient Immunity) – Output Low	All Devices	$T_A = 25^\circ\text{C}$ , $I_F = 1.6 \text{ mA}$ , $V_O < 0.8 \text{ V}$ , $R_L = 4.7 \text{ k}\Omega$ , $V_{CM} = 1000 \text{ V}$ (Note 7), Figure 14	–	20	–	$\text{kV}/\mu\text{s}$

7. Common-mode transient immunity at output high is the maximum tolerable positive  $dV_{CM}/dt$  on the leading edge of the common-mode impulse signal,  $V_{CM}$ , to assure that the output remains high.

# FODM8801A, FODM8801B, FODM8801C

## TYPICAL PERFORMANCE CURVES

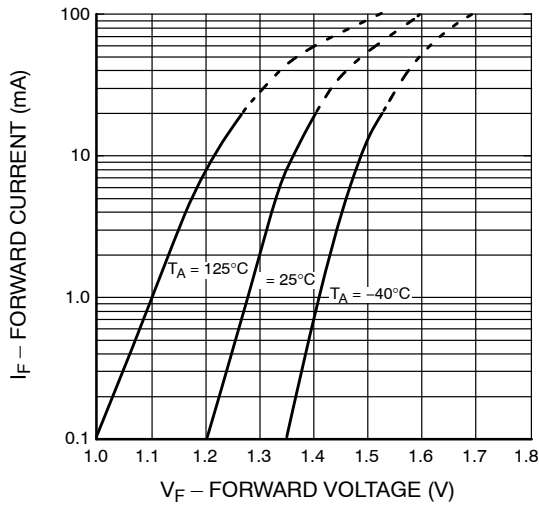

Figure 1. Forward Current vs. Forward Voltage

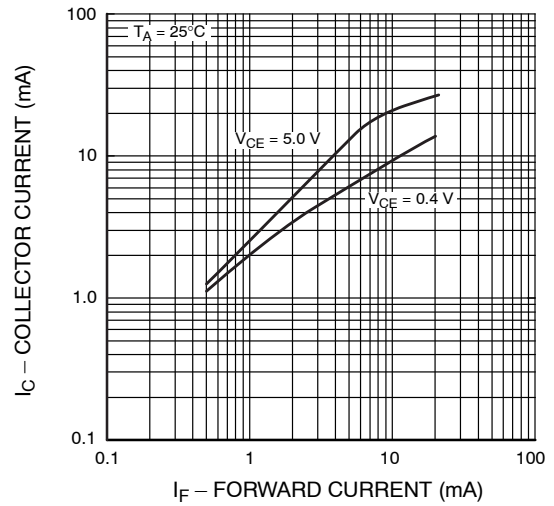

Figure 2. Collector Current vs. Forward Current

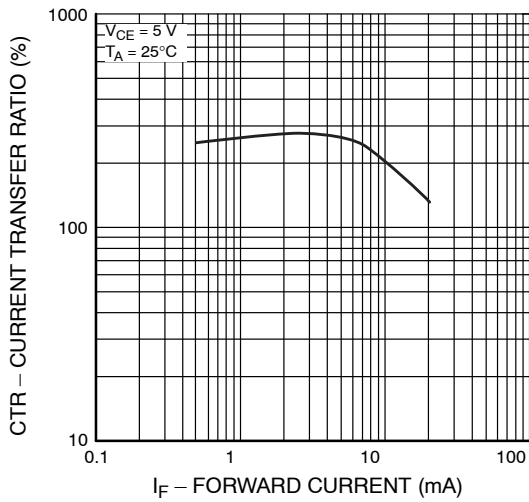

Figure 3. Current Transfer Ratio vs. Forward Current

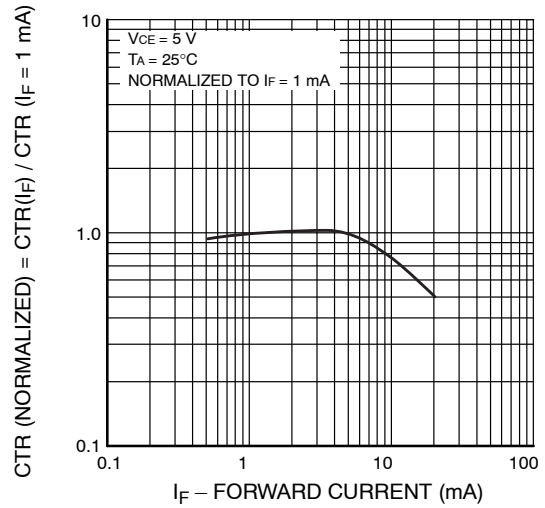

Figure 4. Normalized CTR vs. Forward Current

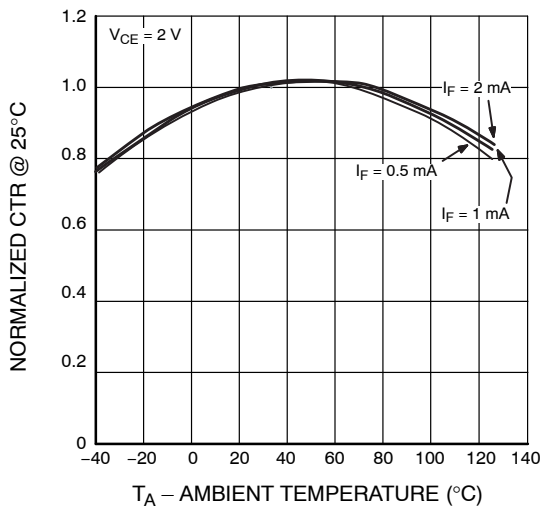

Figure 5. Normalized CTR vs. Ambient Temperature

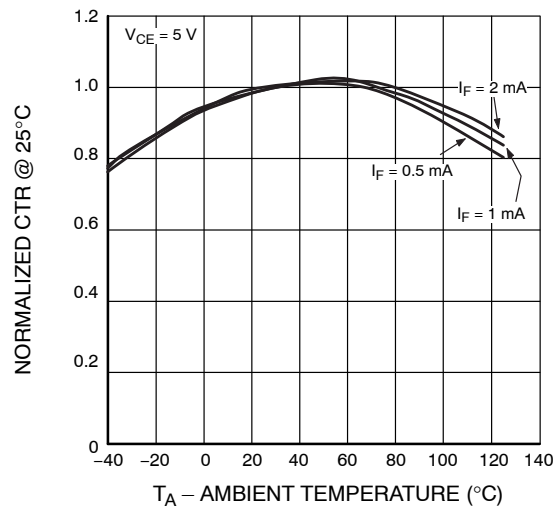
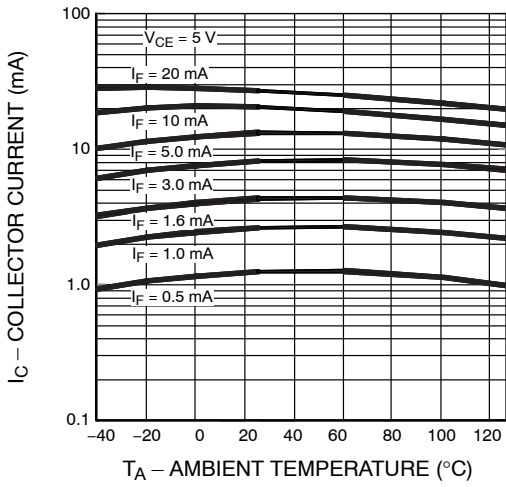

Figure 6. Normalized CTR vs. Ambient Temperature

# FODM8801A, FODM8801B, FODM8801C

## TYPICAL PERFORMANCE CURVES (continued)



**Figure 7. Collector Current vs. Ambient Temperature**

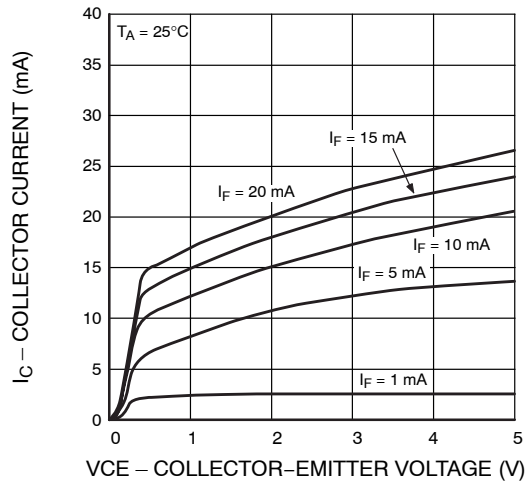

**Figure 8. Collector Current vs. Collector-Emitter Voltage**

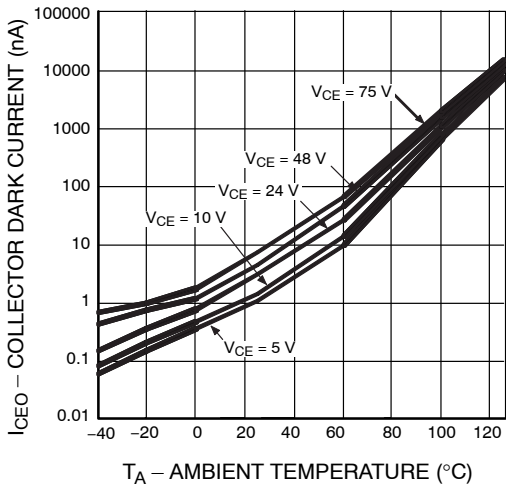

**Figure 9. Collector Dark Current vs. Ambient Temperature**

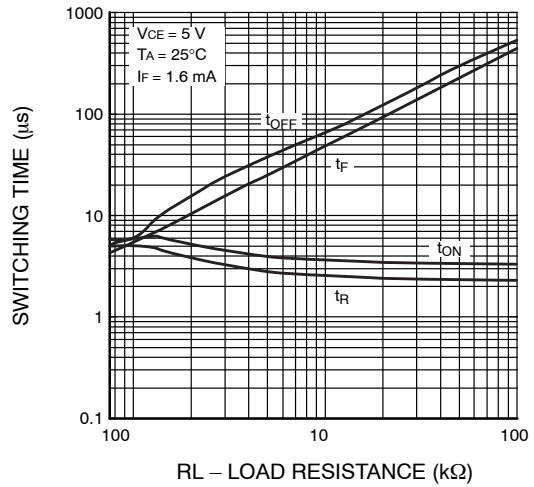

**Figure 10. Switching Time vs. Load Resistance**

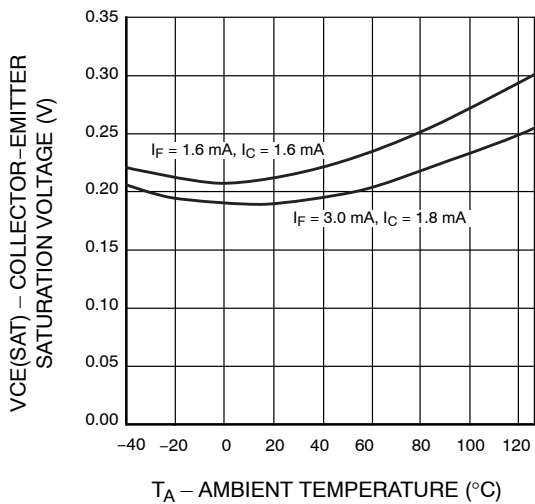

**Figure 11. Collector-Emitter Saturation Voltage vs. Ambient Temperature**

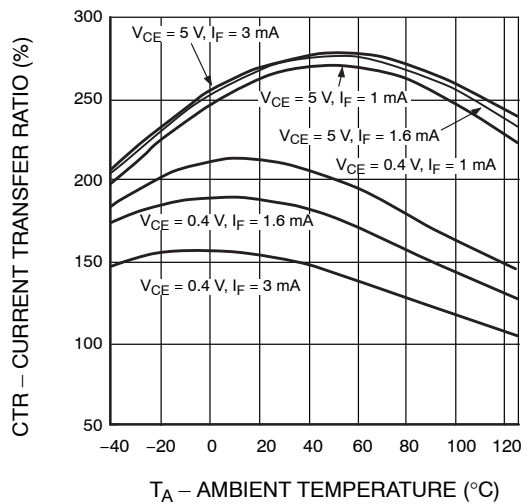

**Figure 12. Current Transfer Ratio vs. Ambient Temperature**

# FODM8801A, FODM8801B, FODM8801C

## TEST CIRCUITS

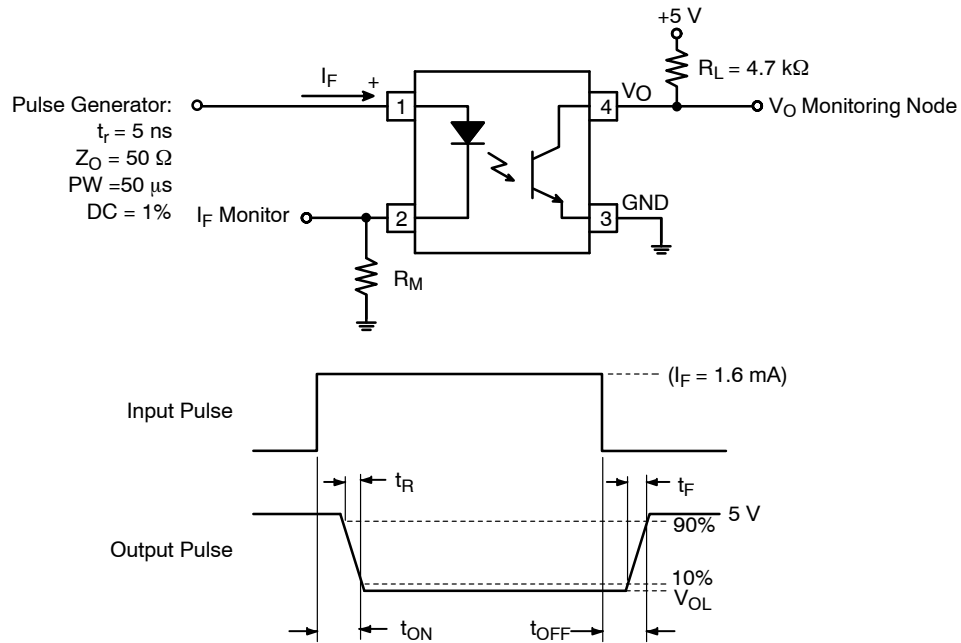

Figure 13. Test Circuit for Propagation Delay, Rise Time, and Fall Time

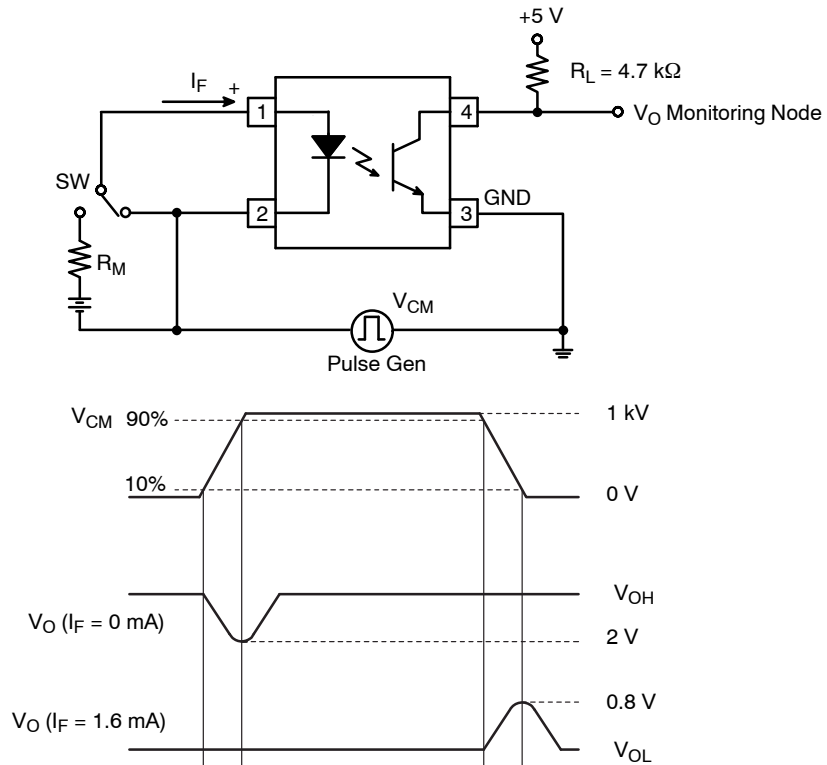

Figure 14. Test Circuit for Instantaneous Common-Mode Rejection Voltage



# FODM8801A, FODM8801B, FODM8801C

## REFLOW PROFILE

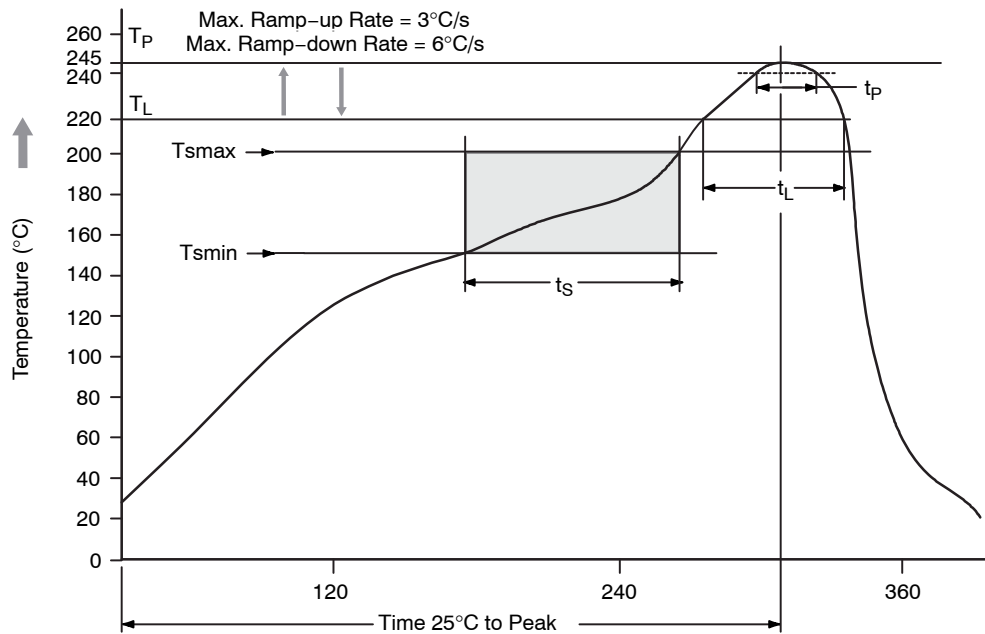

Figure 15. Reflow Profile

Table 1. REFLOW PROFILE

Profile Feature	Pb-Free Assembly Profile
Temperature Minimum (T <sub>min</sub> )	150°C
Temperature Maximum (T <sub>max</sub> )	200°C
Time (t <sub>s</sub> ) from (T <sub>min</sub> to T <sub>max</sub> )	60 – 120 seconds
Ramp-up Rate (t <sub>L</sub> to t <sub>p</sub> )	3°C/second maximum
Liquidous Temperature (T <sub>L</sub> )	217°C
Time (t <sub>L</sub> ) Maintained Above (T <sub>L</sub> )	60 – 150 seconds
Peak Body Package Temperature	245°C +0°C / -5°C
Time (t <sub>p</sub> ) within 5°C of 245°C	30 seconds
Ramp-down Rate (T <sub>P</sub> to T <sub>L</sub> )	6°C/second maximum
Time 25°C to Peak Temperature	8 minutes maximum

### ORDERING INFORMATION

Part Number	Package	Shipping†
FODM8801A	Half Pitch Mini-Flat 4-Pin	150 Units / Tube
FODM8801AR2	Half Pitch Mini-Flat 4-Pin	2500 / Tape & Reel
FODM8801AV	Half Pitch Mini-Flat 4-Pin, DIN EN/IEC60747-5-5 Option	150 Units / Tube
FODM8801AR2V	Half Pitch Mini-Flat 4-Pin, DIN EN/IEC60747-5-5 Option	2500 / Tape & Reel

†For information on tape and reel specifications, including part orientation and tape sizes, please refer to our Tape and Reel Packaging Specifications Brochure, BRD8011/D.

8. The product orderable part number system listed in this table also applies to the FODM8801B, FODM8801C products.

OptoHIT is trademark of Semiconductor Components Industries, LLC (SCILLC) or its subsidiaries in the United States and/or other countries.

**MECHANICAL CASE OUTLINE**  
**PACKAGE DIMENSIONS**

ON Semiconductor®



**MFP4 2.5X4.4, 1.27P**  
CASE 100AL  
ISSUE O

DATE 31 AUG 2016

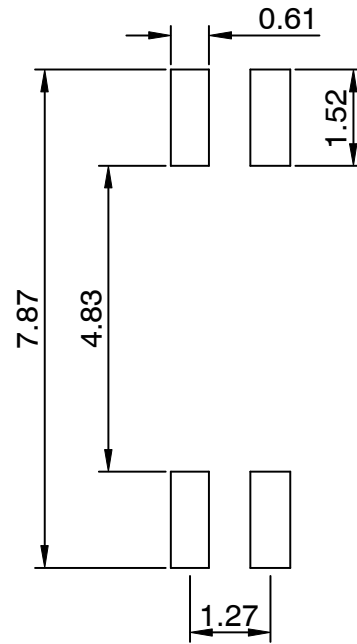
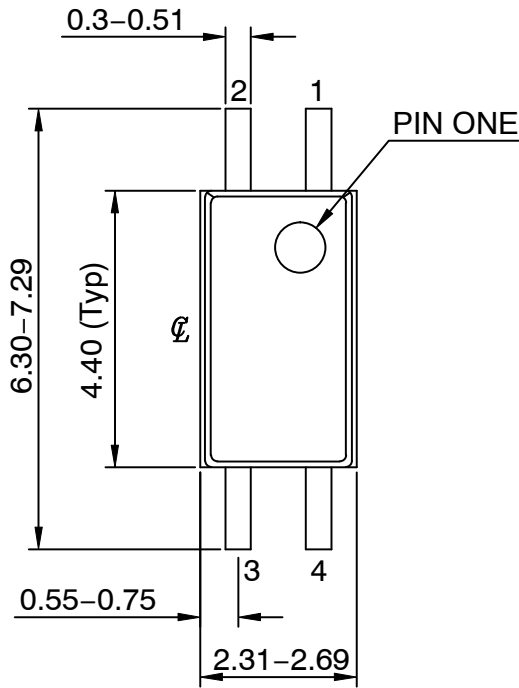

**LAND PATTERN RECOMMENDATION**

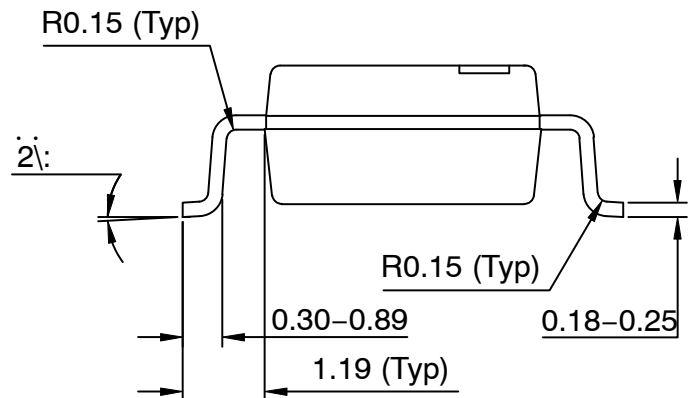
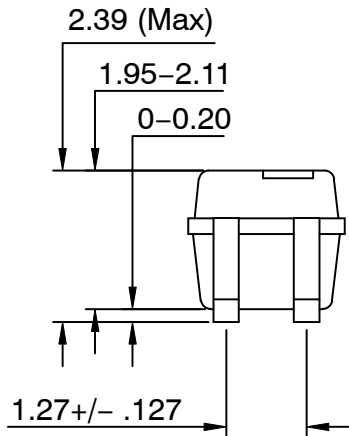

**NOTES:**

- A) NO STANDARD APPLIES TO THIS PACKAGE
- B) ALL DIMENSIONS ARE IN MILLIMETERS.
- C) DIMENSIONS ARE EXCLUSIVE OF BURRS, MOLD FLASH, AND TIE BAR EXTRUSION

<b>DOCUMENT NUMBER:</b>	<b>98AON13485G</b>	Electronic versions are uncontrolled except when accessed directly from the Document Repository. Printed versions are uncontrolled except when stamped "CONTROLLED COPY" in red.
<b>DESCRIPTION:</b>	<b>MFP4 2.5X4.4, 1.27P</b>	<b>PAGE 1 OF 1</b>

ON Semiconductor and are trademarks of Semiconductor Components Industries, LLC dba ON Semiconductor or its subsidiaries in the United States and/or other countries. ON Semiconductor reserves the right to make changes without further notice to any products herein. ON Semiconductor makes no warranty, representation or guarantee regarding the suitability of its products for any particular purpose, nor does ON Semiconductor assume any liability arising out of the application or use of any product or circuit, and specifically disclaims any and all liability, including without limitation special, consequential or incidental damages. ON Semiconductor does not convey any license under its patent rights nor the rights of others.

**onsemi**, **Onsemi**, and other names, marks, and brands are registered and/or common law trademarks of Semiconductor Components Industries, LLC dba "**onsemi**" or its affiliates and/or subsidiaries in the United States and/or other countries. **onsemi** owns the rights to a number of patents, trademarks, copyrights, trade secrets, and other intellectual property. A listing of **onsemi**'s product/patent coverage may be accessed at [www.onsemi.com/site/pdf/Patent-Marking.pdf](http://www.onsemi.com/site/pdf/Patent-Marking.pdf). **onsemi** reserves the right to make changes at any time to any products or information herein, without notice. The information herein is provided "as-is" and **onsemi** makes no warranty, representation or guarantee regarding the accuracy of the information, product features, availability, functionality, or suitability of its products for any particular purpose, nor does **onsemi** assume any liability arising out of the application or use of any product or circuit, and specifically disclaims any and all liability, including without limitation special, consequential or incidental damages. Buyer is responsible for its products and applications using **onsemi** products, including compliance with all laws, regulations and safety requirements or standards, regardless of any support or applications information provided by **onsemi**. "Typical" parameters which may be provided in **onsemi** data sheets and/or specifications can and do vary in different applications and actual performance may vary over time. All operating parameters, including "Typicals" must be validated for each customer application by customer's technical experts. **onsemi** does not convey any license under any of its intellectual property rights nor the rights of others. **onsemi** products are not designed, intended, or authorized for use as a critical component in life support systems or any FDA Class 3 medical devices or medical devices with a same or similar classification in a foreign jurisdiction or any devices intended for implantation in the human body. Should Buyer purchase or use **onsemi** products for any such unintended or unauthorized application, Buyer shall indemnify and hold **onsemi** and its officers, employees, subsidiaries, affiliates, and distributors harmless against all claims, costs, damages, and expenses, and reasonable attorney fees arising out of, directly or indirectly, any claim of personal injury or death associated with such unintended or unauthorized use, even if such claim alleges that **onsemi** was negligent regarding the design or manufacture of the part. **onsemi** is an Equal Opportunity/Affirmative Action Employer. This literature is subject to all applicable copyright laws and is not for resale in any manner.

## ADDITIONAL INFORMATION

### TECHNICAL PUBLICATIONS:

Technical Library: [www.onsemi.com/design/resources/technical-documentation](http://www.onsemi.com/design/resources/technical-documentation)  
onsemi Website: [www.onsemi.com](http://www.onsemi.com)

### ONLINE SUPPORT: [www.onsemi.com/support](http://www.onsemi.com/support)

For additional information, please contact your local Sales Representative at [www.onsemi.com/support/sales](http://www.onsemi.com/support/sales)