

### ● Description

The KPC357 is DC-input single channel which contains a light emitting diode optically coupled to a phototransistor. It is packaged in a 4-pin Mini-Flat package. The input-output isolation voltage is rated at 3750 Vrms.

### ● Schematic

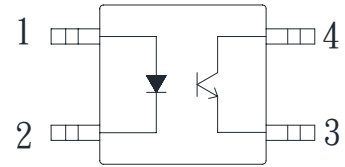

1. Anode
2. Cathode
3. Emitter
4. Collector

### ● Features

1. Halogen free
2. Pb free and RoHS compliant
3. Mini-flat package: compact 4 pin SOP with a 2.0mm profile
4. Current transfer ratio  
(CTR : Min.50% at  $I_F=5\text{mA}$   $V_{ce}=5\text{V}$ )
5. Isolation voltage between input and output  
(Viso : 3750vrms).
6. Agency Approvals:
  - UL1577, File No. E169586
  - VDE EN 60747-5-2, File No.40014684
  - FIMKO EN 60065, File No. FI 23147 A2
  - FIMKO EN 60950-1, File No. FI 24583 A2
  - CQC GB4943 / GB8898-2011, File No. CQC10001049555 / CQC08001023986

### ● Applications

- Hybrid substrates that require high density mounting
- Programmable controllers
- DC-DC converters
- Telecommunication equipments

● **Outside Dimension**

Unit : mm

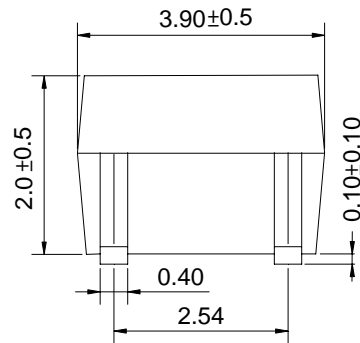
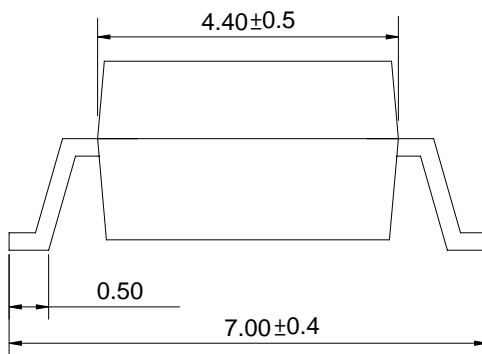
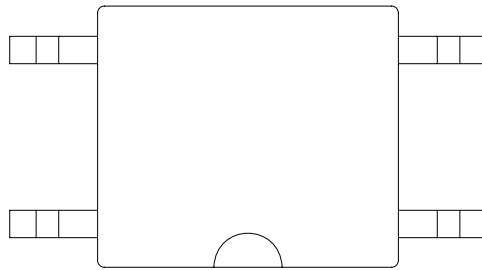

TOLERANCE : ±0.2mm

● **Device Marking**



**Notes:**

Cosmo  
357NT  
YWW

Y: Year code / WW: Week code



□: CTR rank

● **Absolute Maximum Ratings**

(Ta=25°C)

Parameter		Symbol	Rating	Unit
Input	Forward current	$I_F$	50	mA
	Peak forward current	$I_{FM}$	1	A
	Reverse voltage	$V_R$	6	V
	Power dissipation	$P_D$	70	mW
Output	Collector-Emitter voltage	$V_{CEO}$	80	V
	Emitter-Collector voltage	$V_{ECO}$	5	V
	Collector current	$I_C$	50	mA
	Collector power dissipation	$P_C$	150	mW
Total power dissipation		$P_{tot}$	170	mW
Isolation voltage 1 minute		$V_{iso}$	3750	Vrms
Operating temperature		$T_{opr}$	-55 to +115	°C
Storage temperature		$T_{stg}$	-55 to +125	°C
Soldering temperature 10 seconds		$T_{sol}$	260	°C

● **Electro-optical Characteristics**

(Ta=25°C)

Parameter		Symbol	Conditions	Min.	Typ.	Max.	Unit
Input	Forward voltage	$V_F$	$I_F=20mA$	-	1.2	1.4	V
	Reverse current	$I_R$	$V_R=4V$	-	-	10	uA
	Terminal capacitance	$C_t$	$V=0, f=1KHz$	-	30	250	pF
Output	Collector dark current	$I_{CEO}$	$V_{CE}=20V, I_F=0$	-	-	0.1	uA
	Collector-Emitter breakdown voltage	$BV_{CEO}$	$I_C=100uA, I_F=0$	80	-	-	V
	Emitter-Collector breakdown voltage	$BV_{ECO}$	$I_E=100uA, I_F=0$	5	-	-	V
Transfer characteristics	Current transfer ratio	CTR	$I_F=5mA, V_{CE}=5V$	50	-	600	%
			$I_F=1mA, V_{CE}=5V$	15	-	-	%
	Collector-Emitter saturation voltage	$V_{CE(sat)}$	$I_F=20mA, I_C=1mA$	-	0.1	0.3	V
	Isolation resistance	Riso	DC500V, 40 to 60%RH	$5 \times 10^{10}$	$10^{11}$	-	$\Omega$
	Floating capacitance	$C_f$	$V=0, f=1MHz$	-	0.6	1.0	pF
	Response time (Rise)	tr	$V_{ce}=2V, I_C=2mA, R_L=100\Omega$	-	5	20	us
	Response time (Fall)	tf		-	4	20	us

Classification table of current transfer ratio is shown below.

CTR Rank.	CTR (%)
KPC357NT0A	80 TO 160
KPC357NT0B	130 TO 260
KPC357NT0C	200 TO 400
KPC357NT0D	300 TO 600
KPC357NT0E	50 TO 600

Fig.1 Current Transfer Ratio vs. Forward Current

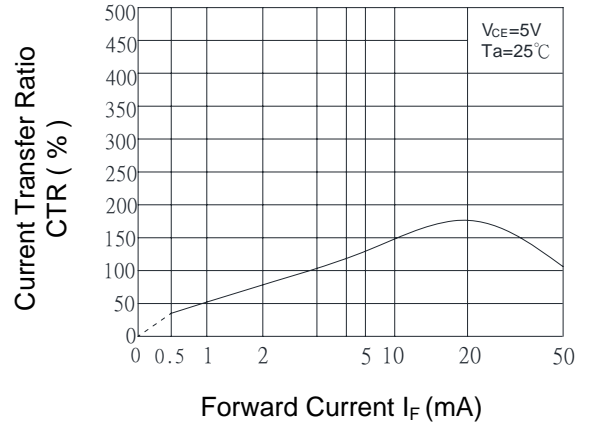

Fig.2 Collector Power Dissipation vs. Ambient Temperature

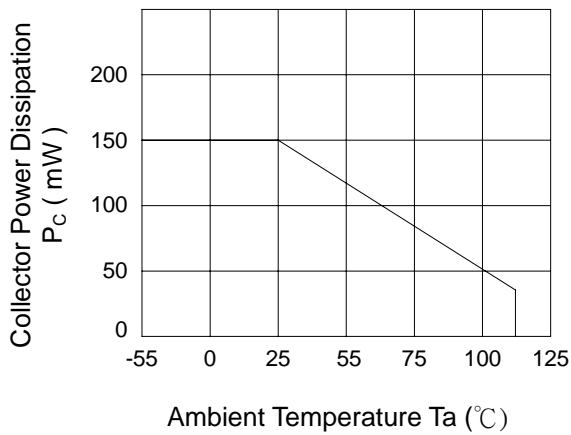

Fig.3 Collector Dark Current vs. Ambient Temperature

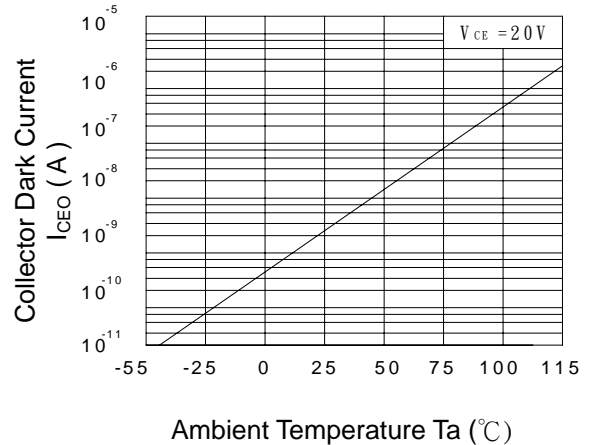

Fig.4 Forward Current vs. Ambient Temperature

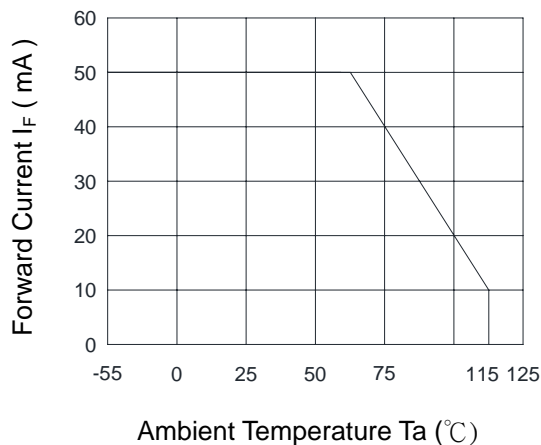
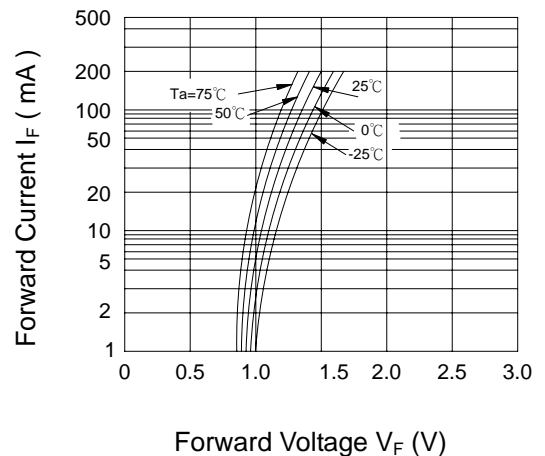
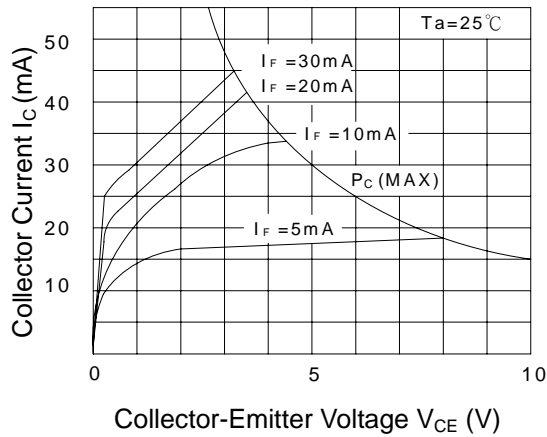

Fig.5 Forward Current vs. Forward Voltage



**Fig.6 Collector Current vs. Collector-Emitter Voltage**



**Fig.7 Relative Current Transfer Ratio vs. Ambient Temperature**

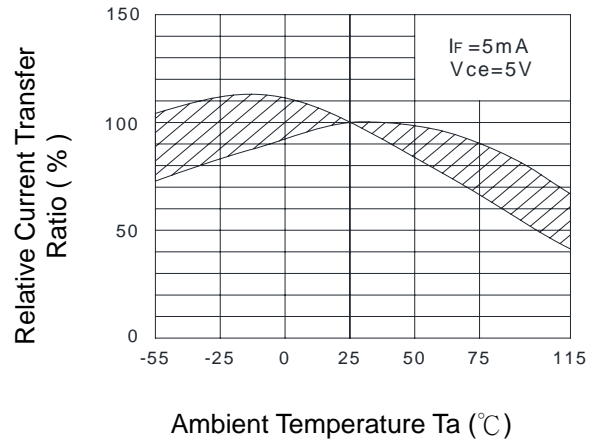

**Fig.8 Collector-Emitter Saturation Voltage vs. Ambient Temperature**

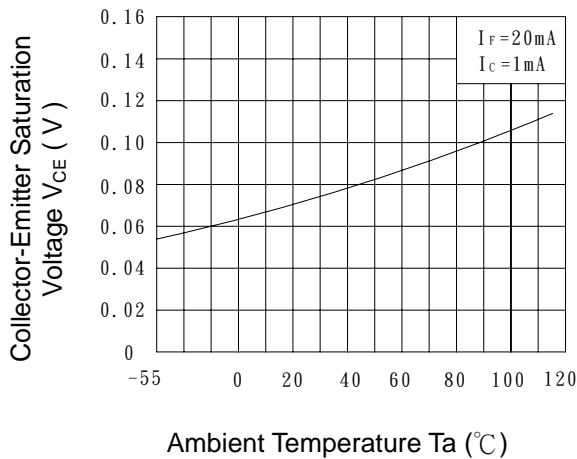

**Fig.9 Collector-Emitter Saturation Voltage vs. Forward Current**

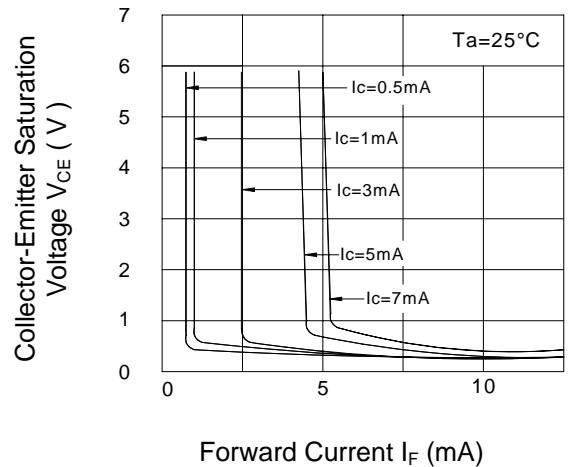

**Fig.10 Response Time (Rise) vs. Load Resistance**

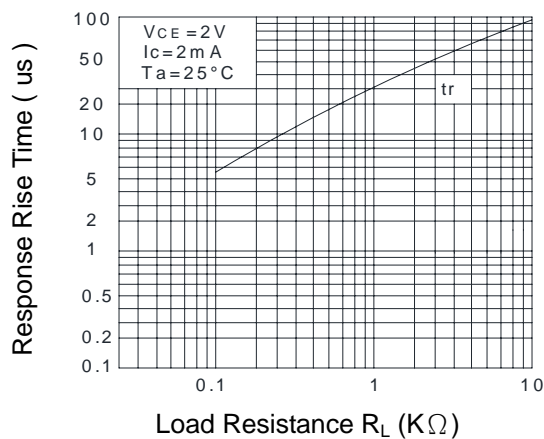

**Fig.11 Response Time (Fall) vs. Load Resistance**

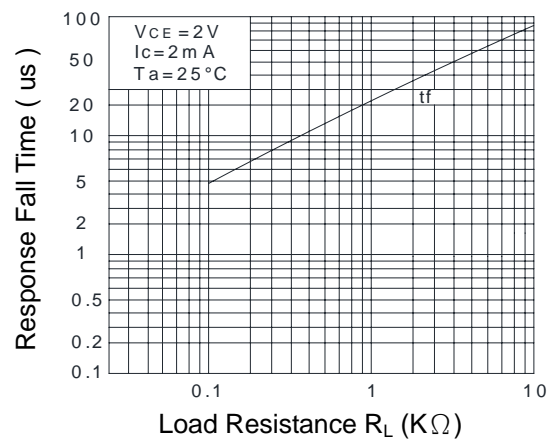

- Test Circuit For Response Time

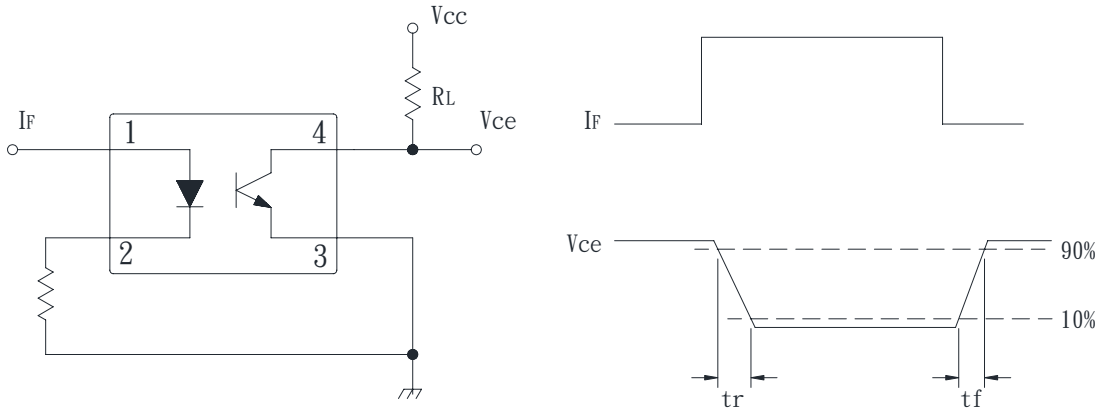

### ● Recommended Soldering Conditions

#### (a) Infrared reflow soldering :

- Peak reflow soldering : 260°C or below (package surface temperature)
- Time of peak reflow temperature : 10 sec
- Time of temperature higher than 230°C : 30-60 sec
- Time to preheat temperature from 180~190°C : 60-120 sec
- Time(s) of reflow : Two
- Flux : Rosin flux containing small amount of chlorine (The flux with a maximum chlorine content of 0.2 Wt% is recommended.)

#### Recommended Temperature Profile of Infrared Reflow

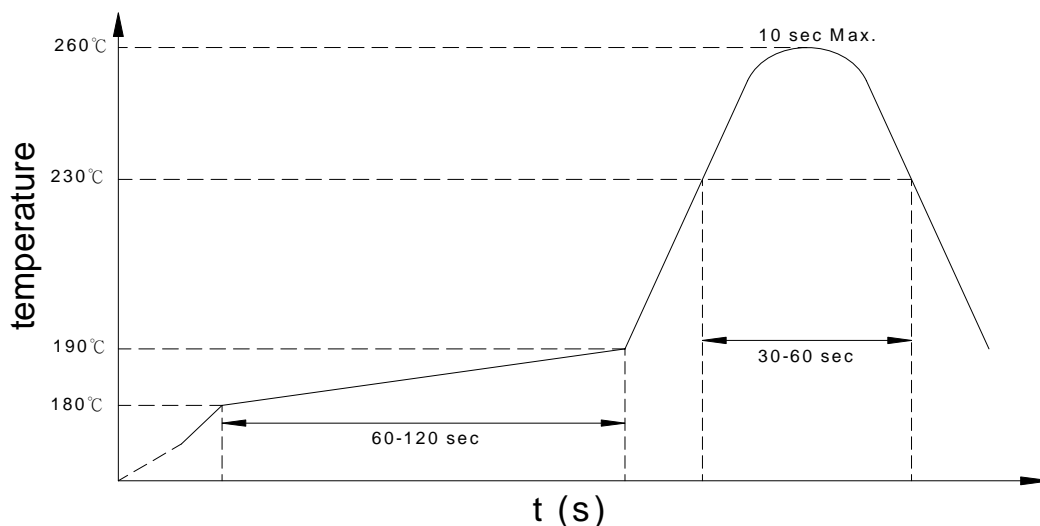

#### (b) Wave soldering :

- Temperature : 260°C or below (molten solder temperature)
- Time : 10 seconds or less
- Preheating conditions : 120°C or below (package surface temperature)
- Time(s) of reflow : One
- Flux : Rosin flux containing small amount of chlorine (The flux with a maximum chlorine content of 0.2 Wt% is recommended.)

#### (c) Cautions :

- Fluxes : Avoid removing the residual flux with freon-based and chlorine-based cleaning solvent.
- Avoid shorting between portion of frame and leads.

- **Numbering System**

## KPC357NT Y (Z)

**Notes:**

KPC357NT = Part No.

Y = CTR rank option (A ~ E)

Z = Tape and reel option (TLD、TRU)

Option	Description	Packing quantity
TLD	TLD tape & reel option	3000 units per reel
TRU	TRU tape & reel option	3000 units per reel

- **Recommended Pad Layout for Surface Mount Lead Form**

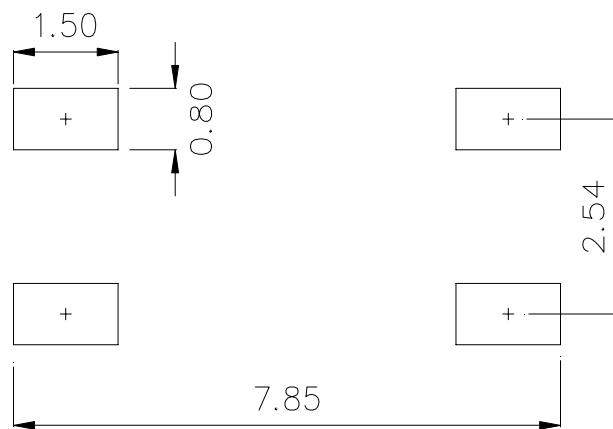
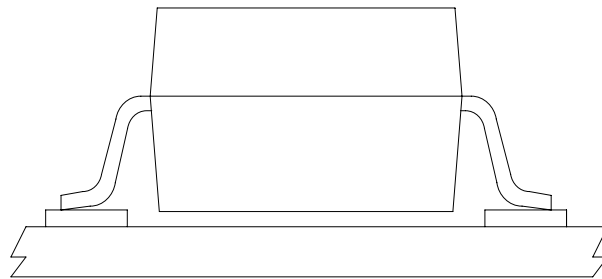

Unit : mm



● 4-pin Mini-Flat Carrier Tape & Reel

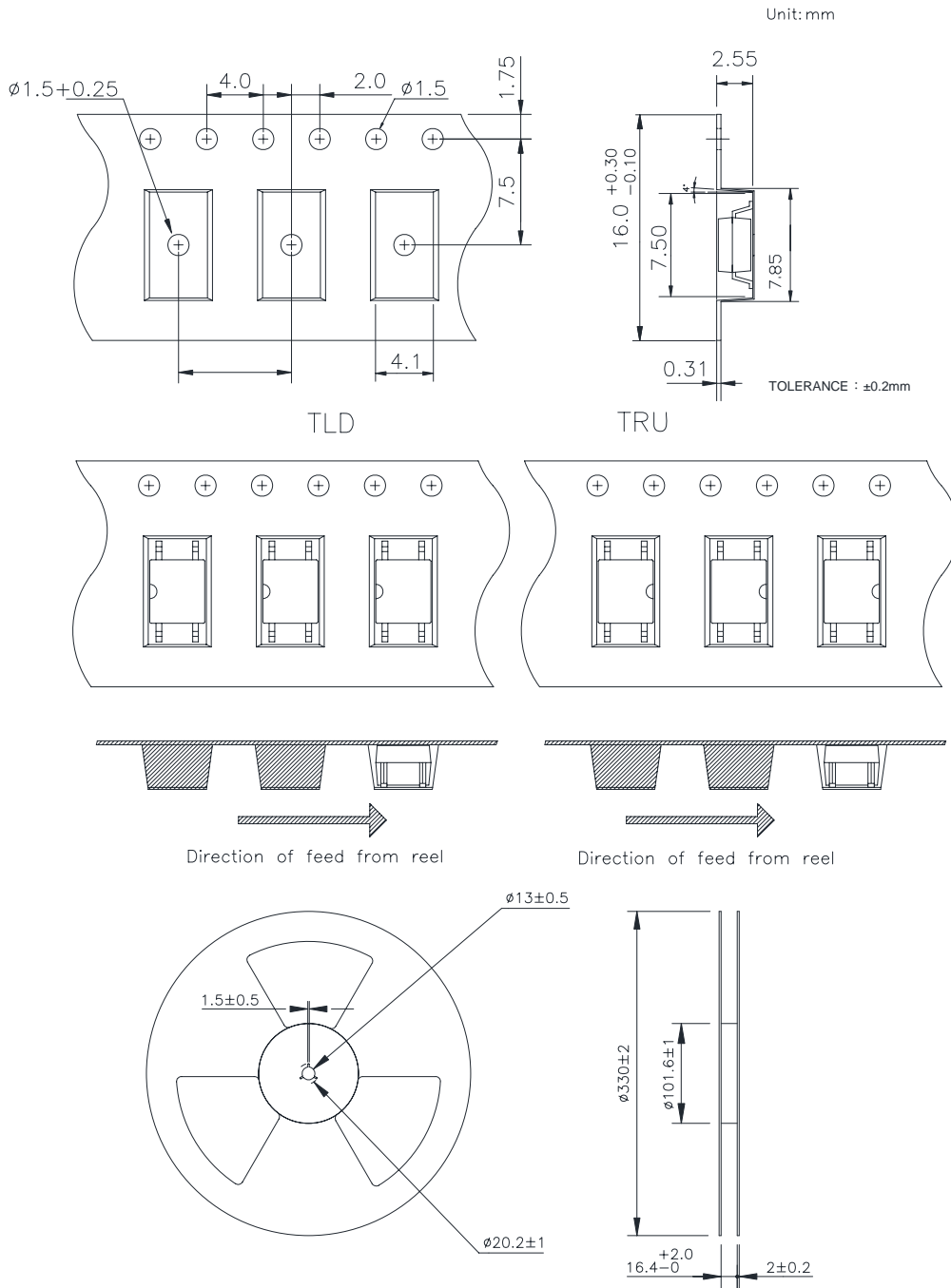



# KPC357NT Series

## 4PIN MINI-FLAT PHOTOTRANSISTOR PHOTOCOUPLER

---

### ● Application Notice

The content of datasheet is the guidance for product use only. cosmo takes no responsibility to the accuracy of the information provided here. For continuously improving all of products, including quality, reliability, function...etc., cosmo reserves the right to change the specification, characteristics, data, materials, and structure of products without notice. Please contact with cosmo to obtain the latest specification.

It would be required to comply with the absolute maximum ratings listed in the specification. cosmo has no liability and responsibility to the damage caused by improper use of the products.

cosmo products are intended to be designed for use in general electronics application list below:

- a. Personal computer
- b. OA machine
- c. Audio / Video
- d. Instrumentation
- e. Electrical application
- f. Measurement equipment
- g. Consumer electronics
- h. Telecommunication

cosmo devices shall not be used or related with equipment requiring higher level of quality / reliability, or malfunction, or failure which may cause loss of human life, bodily injury, includes, without limitation:

- a. Medical and other life supporting equipments
- b. Space application
- c. Telecommunication equipment (trunk lines)
- d. Nuclear power control
- e. Equipment used for automotive vehicles, trains, ships...etc.

This publication is the property of cosmo. No part of this publication may be reproduced or copied in any form or any means electronically or mechanically for any purpose, in whole or in part without any written permission expressed from cosmo.