

1. PART NUMBER

e.g.: C2012N680J101NT

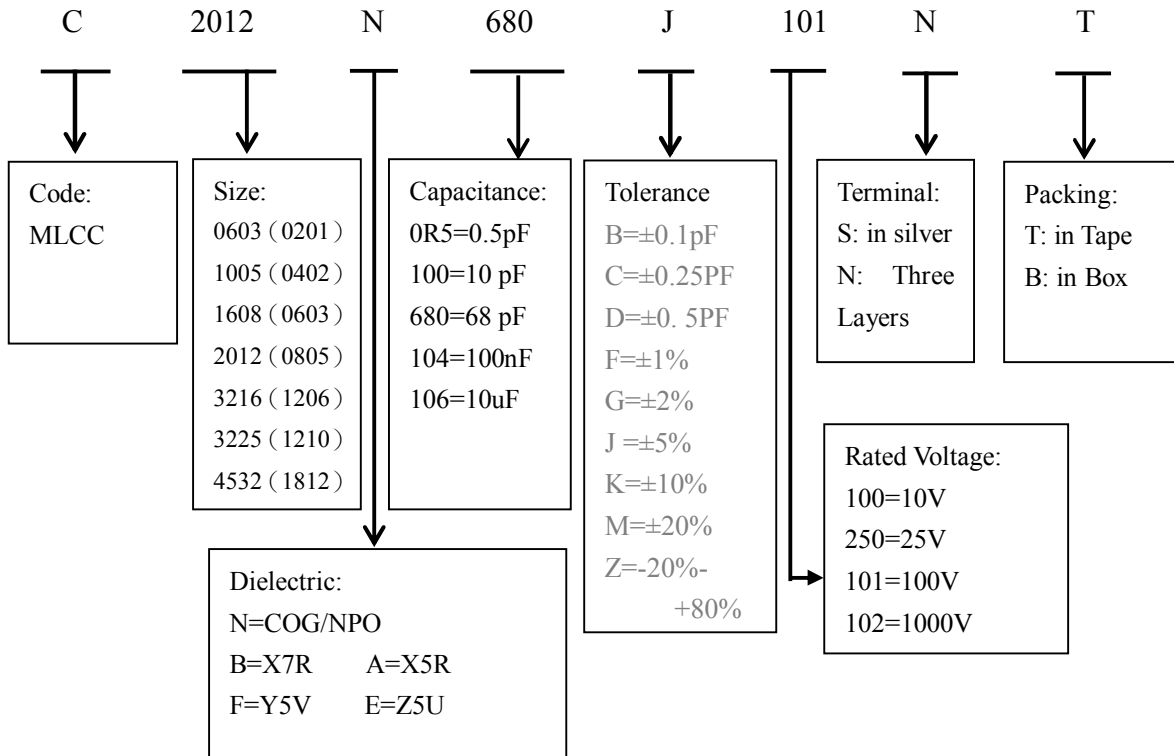

2. STRUCTURE

介质: Dielectric 电极: Electrode 端头: Terminal 银: Silver 镍: Nickel 锡: Tin

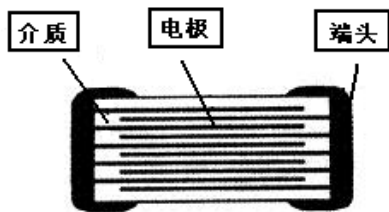

Inner Structure

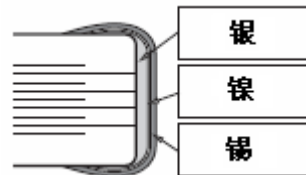

Three Electrode layers

3. SIZE AND ELECTRICAL PARAMETERS

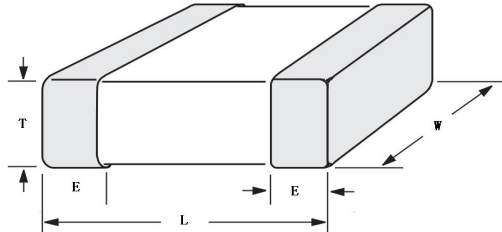

SIZE (mm)		DIMENSION (mm)			
INCH	METRIC	L	W	T	E
0201	0603	0.6 ± 0.03	0.3 ± 0.03	0.3 ± 0.03	0.15 ± 0.05
0402	1005	1.00 ± 0.05	0.50 ± 0.05	0.50 ± 0.05	0.25 ± 0.10
0603	1608	1.60 ± 0.10	0.80 ± 0.10	0.80 ± 0.10	0.30 ± 0.10
0805	2012	2.00 ± 0.20	1.25 ± 0.20	0.70 ± 0.20	0.50 ± 0.20
				1.00 ± 0.20	
				1.25 ± 0.20	
1206	3216	3.20 ± 0.30	1.60 ± 0.2	0.70 ± 0.20	0.50 ± 0.25
				1.00 ± 0.20	
				1.25 ± 0.20	
1210	3225	3.20 ± 0.30	2.50 ± 0.30	1.25 ± 0.30	0.75 ± 0.25
				1.50 ± 0.30	
1812	4532	4.50 ± 0.40	3.20 ± 0.30	≤ 2.5	0.75 ± 0.20

4. DIELECTRIC CHARACTERISTIC INTRODUCTION AND TEST METHOD

ITEM	STANDARD				TEST METHOD
Capacitance	0.5PF-47uF				COG:
Tolerance	B=±0.1PF	C=±0.25PF	D=±0.5.PF		C≤1000PF : 1MHz±10%
	F=±1%	G=±2%	J=±5%		1.0±0.2Vrms
Rated Voltage	16、25、50、100、200、500、1000、2000 V(DC)				C>1000PF: 1KHz±10%
					1.0±0.2Vrms
Dissipation Factor	COG/NPO	DF≤0.15%			X7R/X5R:
	X7R/X5R	DF ≤ 2.5%(≥ 50V) , ≤ 3.0%(25V) , ≤ 3.5%(16V)			1KHz±10% 1.0±0.2Vrms
	Y5V/Z5U	DF ≤ 7%(C ≥ 100nF) . ≤ 3.5%(C<100nF)			Y5V/Z5U: 1KHz±10% 1.0±0.2Vrms ≤10uF 120Hz 0.5±0.2Vrms >10uF
Insulation Resistance(IR)	COG/NPO	C≤10NF IR>50000MΩ ; C>10NF IR>5000Ω F			Test voltage: rated Time: 1 minute Temperature: 18-25℃ Humidity: <80%
	X7R/X5R	C≤25NF IR>10000MΩ ; C>25NF RXC>100Ω F			
	Y5V/Z5U	C≤25NF IR>4000MΩ ; C>25NF RXC>100Ω F			
Dielectric withstanding voltage	No damage after test				Apply 2.5x rated voltage to both terminations for 5 seconds, charge and discharge current are less than 50mA. (This test doesn't apply to high-voltage MLCC)
Termination Adhesion	No damage after test				Test Condition: 5N 10±1S
Bending Strength	No damage after test and capacitance tolerance shall not be more than 10%				After soldering capacitor on the PCB, 1mm per 1 second of bending for this PCB shall be applied.
Solderability	Temperature	235±5℃			Completely immerse the capacitor in the molthen rosin for 2s and then put it in the 10mm molthen solder with a temperature of 235±5℃ (265±5℃) for 2(5)s. after that pick it up, clean the solvent and inspect it under 10x or more microscope.
	Time	1±1S			
	Cover	≥95			
Resistance to soldering Heat	Tempertaure	265±5℃			
	Time	1±1S			
	Cover	≥95			
	ΔC/C	≤0.5% or 0.5PF			
Temperature Cycling	Dielectric	COG/NPO	X7R/X5R	Y5V/Z5U	Temperature: -55 ± 3 ℃ ~125 ± 3 ℃ COG/X7R -25±3℃~85±3℃ Y5V -10±3℃~85±3℃ Z5U Cycle times: 5 times per 30s Resume time: 24h
	ΔC/C	≤1%	≤±10%	≤±30%	
	No damage after test				

Humidity and Moisture Resistance	Dielectric	COG/NPO	X7R/X5R	Y5V/Z5U	Permanent Moisture T=40±2°C T=21D Relative Humidity: 93+2~3% Resume Time: 1-2h
	ΔC/C	≤2%	≤10%	≤20%	
	DF	0.03	0.05	0.07	
	IR	RXC>25S	RXC>25S	RXC>25S	
No damage after test					
T.C. characteristics	dielectric	ΔC/C		T.C.	
	COG/NPO	±30PPM		+20°C → -55°C → +20°C → +125°C	
	X7R/X5R	±15°C		+20°C → -55°C → +20°C → +125°C	
	Z5U	±22%~56%		+20°C → +10°C → +20°C → +85°C	
	Y5V	±22%~82%		+20°C → -25°C → +20°C → +85°C	
Vibration	No damage after test			f=10-500Hz 0.75MM/2S	
Bump	No damage after test			4000 times	
Life test	dielectric	COG/NPO	X7R/X5R	Y5V/Z5U	Temperature: +125°C NPO/X7R +85°C Y5V/Z5U T=100 h Resume time: 24h
	ΔC/C	≤2%	≤±12.5%	≤±30%	
	DF	0.003	0.003	0.05	
	IR	RXC>25S	RXC>25S	RXC>25S	

5. T.C.CHARACTERISTICS

Dielectric	NPO(COG)	X7R(X5R)	Y5V
Operating Temperature	-55~125°C	-55~125(85)°C	-30~85°C
T.C.Characteristics	±30PPM/°C	±15%	-20~+80%

COG8/NPO Typical Characteristics

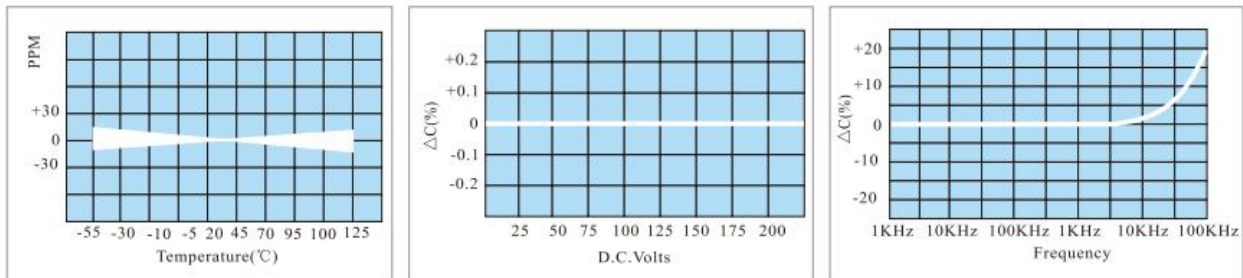

X7R/X5R Typical Characteristics

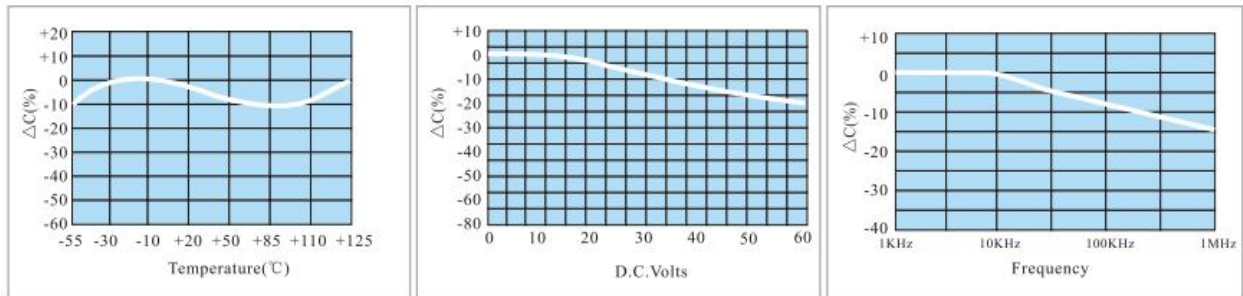

Y5V Typical Characteristics

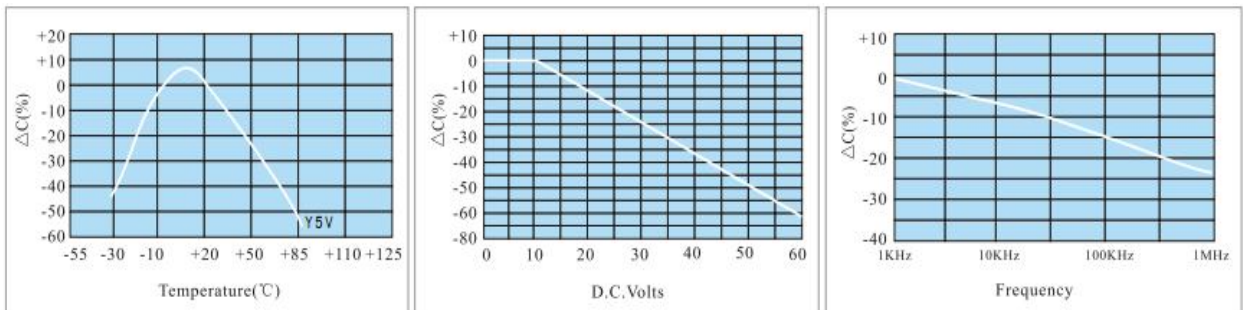

6. VOLTAGE AND CAPACITANCE (COG/NPO)

Size	Voltage	Capacitance
0201	25V	0.5 PF -1000PF
	50V	0.5 PF -680PF
0402	25V	0.5 PF -2200PF
	50V	0.5 PF -2200PF
0603	25V	0.5 PF -10000PF
	50V	0.5 PF -10000PF
0805	25V	0.5 PF -68000PF
	50V	0.5 PF -47000PF
1206	16V	0.5 PF -100000PF
	25V	0.5 PF -100000PF
	50V	0.5 PF -68000PF
1210	25V	470 PF -47000PF
	50V	560 PF -56000PF
1812	25V	1000 PF -100000PF
	50V	1000 PF -47000PF

(X7R/X5R)

Size	Voltage	Capacitance
0402	6.3V	100 PF -1.0 uF
	10V	100 PF -680nF
	16V	100 PF -220nF
0603	6.3V	100 PF -4.7 uF
	10V	100 PF -4.7 uF
	16V	100 PF -2.2 uF
	25V	100 PF -2.2 uF
	50V	100 PF -1.0 uF
0805	6.3V	220 PF -10 uF
	10V	220 PF -10 uF
	16V	220 PF -10 uF
	25V	220 PF -4.7 uF
	50V	220 PF -2.2 uF
1206	6.3V	220 PF -10 uF
	10V	220 PF -10uF
	16V	220 PF -10 uF
	25V	220 PF -10 uF
	50V	220 PF -10 uF
1210	6.3V	1000 PF -47 uF
	10V	1000 PF -22 uF
	16V	1000 PF -22 uF
	25V	1000 PF -22 uF
	50V	1000 PF -10 uF
1812	25V	10000 PF -47 uF
	50V	10000 PF -22 uF

(Y5V)

Size	Voltage	Capacitance
0402	6.3V	100nF -1 uF
	10V	100nF -1 uF
	16V	22nF -680nF
	50V	22nF -680nF
0603	6.3V	680nF-4.7 uF
	10V	22nF -4.7 uF
	16V	22nF -4.7 uF
	25V	22nF -2.2 uF
	50V	22nF -1 uF
0805	6.3V	4.7 uF -10 uF
	10V	2.2 uF -10 uF
	16V	22nF -4.7 uF
	25V	22nF -2.2 uF
	50V	22nF -1 uF
1206	6.3V	/
	10V	2.2uF -22 uF
	16V	1uF -10 uF
	25V	22nF -10 uF
	50V	22nF -10 uF
1210	6.3V	22nF-47 uF
	10V	10uF-22 uF
	16V	2.2uF-10 uF
	25V	220nF-2.2 uF
	50V	22nF -10 uF
1812	25V	10uF-47 uF
	50V	22nF-22uF

7.Packing Information

Reel

Dimension		A	B	C	F	W
0201 0402 0603 0805 1206 1210	mm	178±2.0	60.0±1.0	13.5±0.5	11.4±0.1	9.00±0.3
	Inch	7.008±0.079	2.362±0.039	0.531±0.020	0.449±0.039	0.354±0.012
	mm	178±2.0	60.0±1.0	13.5±0.5	15.4±1.0	13.0±0.3
	Inch	7.008±0.079	2.362±0.039	0.531±0.020	0.606±0.039	0.512±0.012

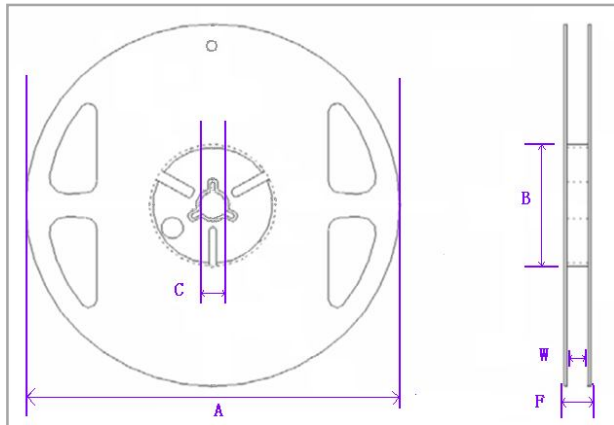

Packing Quantity

	0201	0402	0603	0805	1206	1210	1812
Paper Tape	10K/15K	10K	4K	4K	4K		
Plastic Tape				2K	2K	1K/2K	500PCS

Tape

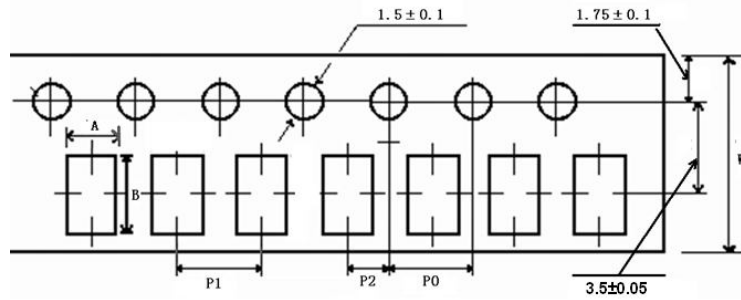

Unit: mm

TYPE	A	B	W	P0	P1	P2
0201	0.38±0.05	0.68±0.05	8.00±0.20	4.00±0.10	2.00±0.10	2.00±0.05
0402	0.65±0.10	1.15±0.10	8.00±0.20	4.00±0.10	2.00±0.10	2.00±0.05
0603	1.10±0.10	1.90±0.10	8.00±0.20	4.00±0.10	4.00±0.10	2.00±0.05
0805	1.65±0.20	2.40±0.20	8.00±0.20	4.00±0.10	4.00±0.10	2.00±0.05
1206	2.00±0.20	3.60±0.20	8.00±0.20	4.00±0.10	4.00±0.10	2.00±0.05
1210	2.80±0.10	3.50±0.10	8.00±0.20	4.00±0.10	4.00±0.10	2.00±0.05
1812	3.60±0.20	4.90±0.20	12.00±0.10	4.00±0.10	4.00±0.10	2.00±0.05

8.WELDING TEMPERATURE

Suitable reflow temperature

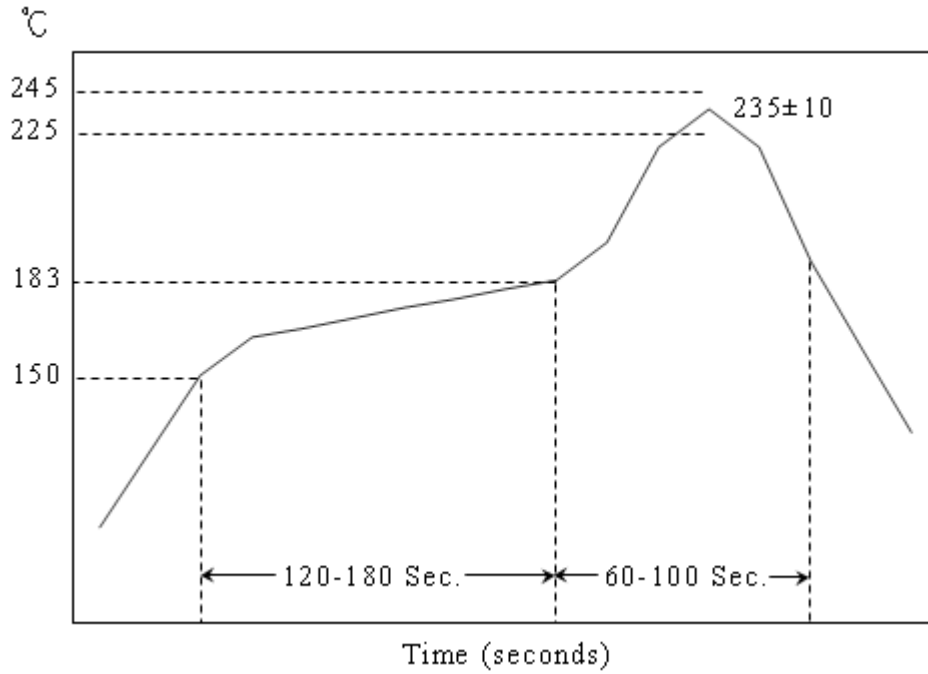

1-2°C/Sec ramp

Preheat 150-183°C: 2-3 minutes

Time above 183°C: 60-100 seconds

Peak Temperature: 230±10°C

Module should only be in oven for 5.5-6 minute