

BIPOLAR TRANSISTOR (NPN)
FEATURES

- Complement To BD136
- High Current

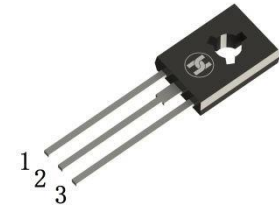

1.EMITTER 2.COLLECTOR 3.BASE

TO-126

Equivalent Circuit

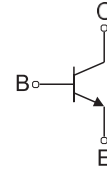
MECHANICAL DATA

- Case: TO-126
- Case Material: Molded Plastic. UL flammability
- Classification Rating: 94V-0
- Moisture Sensitivity: Level 1 per J-STD-020
- Weight: 0.5 grams (approximate)

MAXIMUM RATINGS (T_A = 25°C unless otherwise noted)

Parameter	Symbol	Value	Unit
Collector-Base Voltage	V _{CB0}	45	V
Collector-Emitter Voltage	V _{CEO}	45	V
Emitter-Base Voltage	V _{EBO}	5	V
Collector Current	I _C	1.5	A
Collector Power Dissipation	P _C	1.25	W
Thermal Resistance From Junction To Ambient	R _{θJA}	100	°C/W
Junction Temperature	T _J	150	°C
Storage Temperature	T _{STG}	-55 ~+150	°C

ELECTRICAL CHARACTERISTICS (T_A = 25°C unless otherwise specified)

Parameter	Symbol	Min	Typ	Max	Unit	Conditions
Collector-base breakdown voltage	V _{(BR)CBO} *	45			V	I _C =100μA, I _E =0
Collector-emitter breakdown voltage	V _{(BR)CEO} *	45			V	I _C =30mA, I _B =0
Emitter-base breakdown voltage	V _{(BR)EBO}	5			V	I _E =100μA, I _C =0
Collector cut-off current	I _{CBO}			0.1	μA	V _{CB} =30V, I _E =0
Emitter cut-off current	I _{EBO}			10	μA	V _{EB} =5V, I _C =0
DC current gain	h _{FE} *	40		250		V _{CE} =2V, I _C =150mA
		25				V _{CE} =2V, I _C =5mA
		25				V _{CE} =2V, I _C =500mA
Collector-emitter saturation voltage	V _{CE(sat)} *			0.5	V	I _C =500mA, I _B =50mA
Base-emitter voltage	V _{BE}			1	V	V _{CE} =2V, I _C =500mA

*pulse test: pulse width ≤350μs, duty cycle≤ 2.0%.

CLASSIFICATION OF h_{FE}

Rank	6	10	16
Range	40-100	63-160	100-250

BIPOLAR TRANSISTOR (NPN)

Typical Characteristics

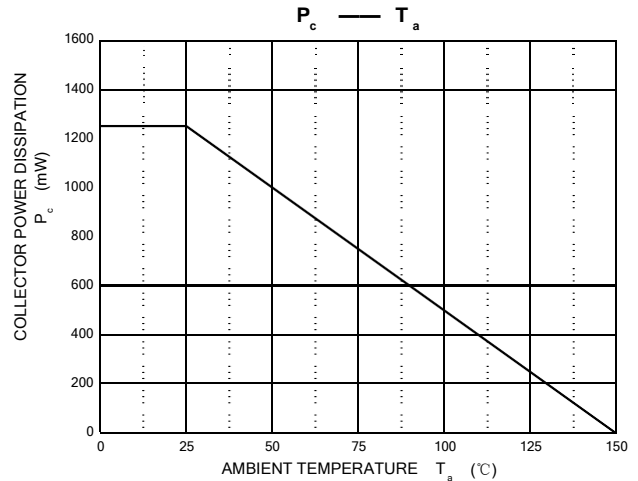
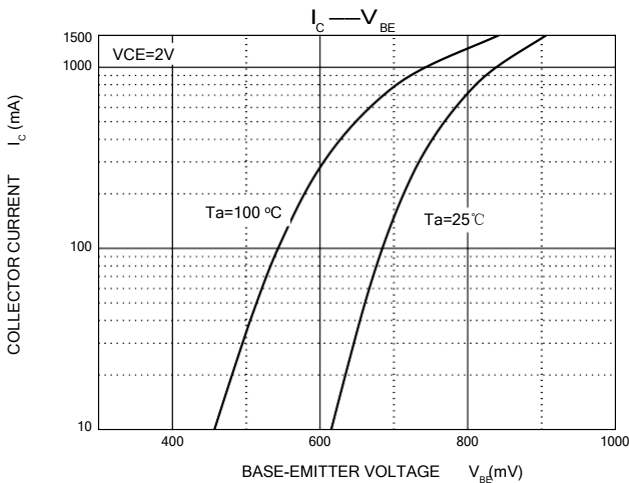
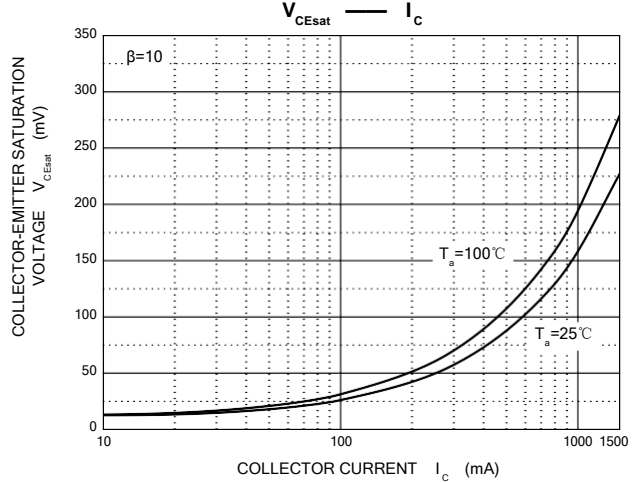
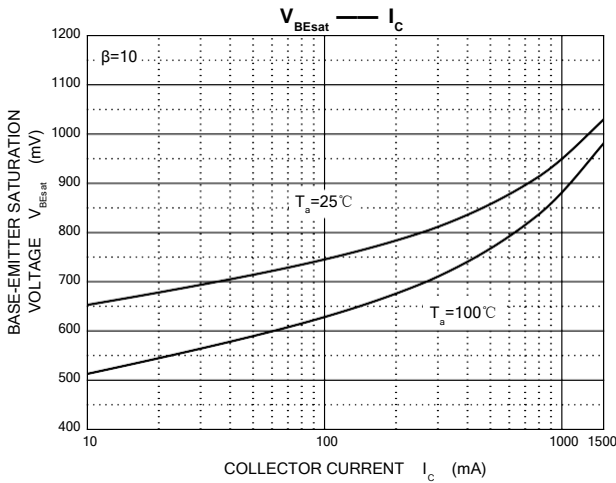
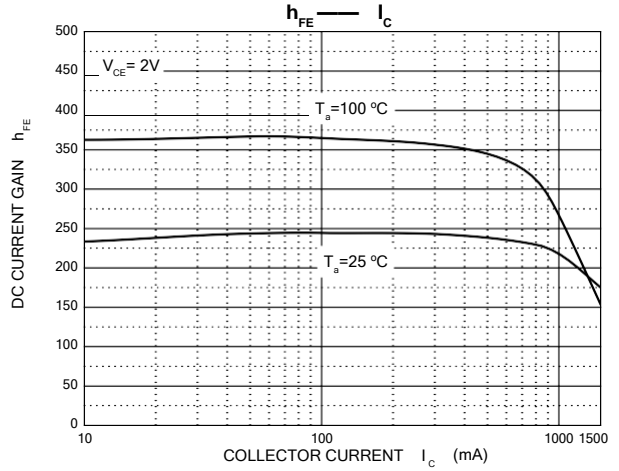
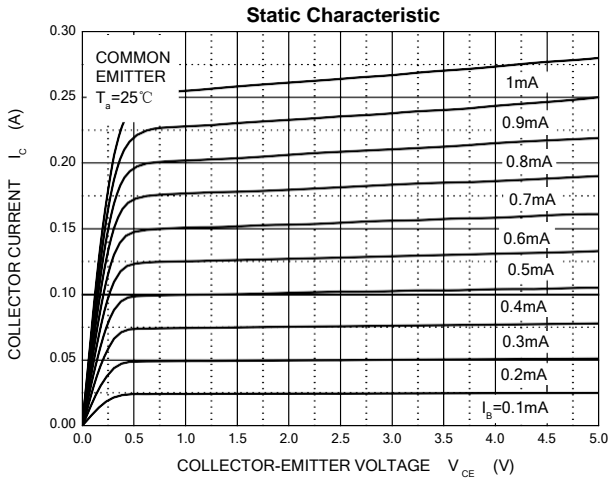

BIPOLAR TRANSISTOR (NPN)

TO-126 Package Outline Dimensions

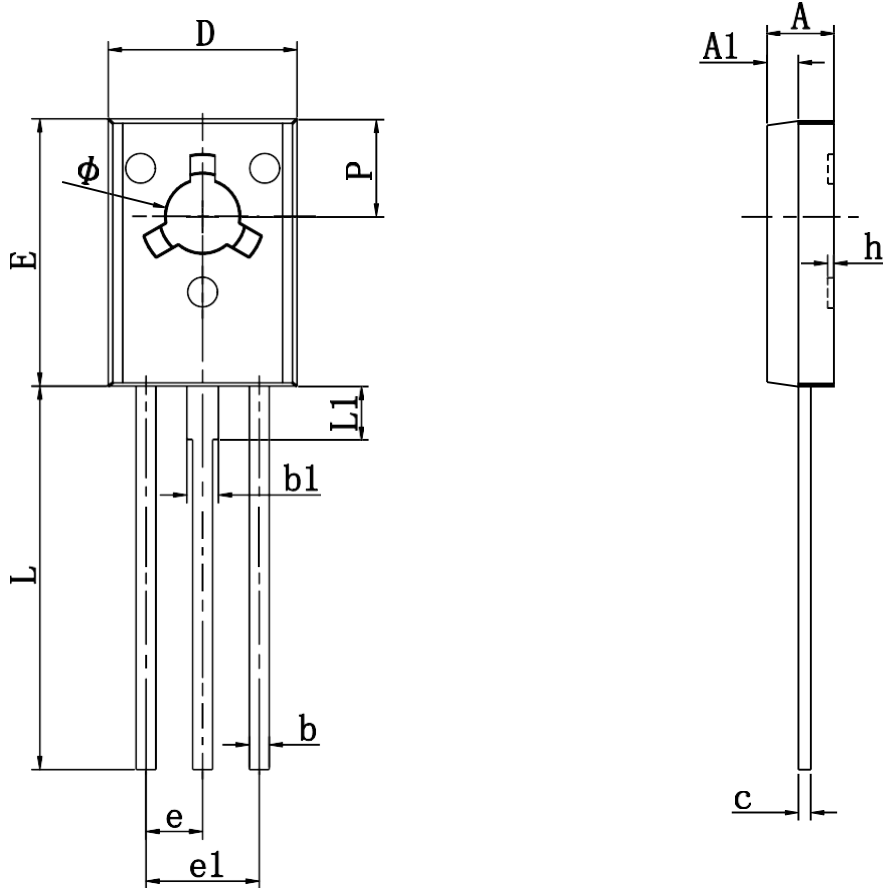

Symbol	Dimensions In Millimeters		Dimensions In Inches	
	Min	Max	Min	Max
A	2.500	2.900	0.098	0.114
A1	1.100	1.500	0.043	0.059
b	0.660	0.860	0.026	0.034
b1	1.170	1.370	0.046	0.054
c	0.450	0.600	0.018	0.024
D	7.400	7.800	0.291	0.307
E	10.600	11.000	0.417	0.433
e	2.290 TYP		0.090 TYP	
e1	4.480	4.680	0.176	0.184
h	0.000	0.300	0.000	0.012
L	15.300	15.700	0.602	0.618
L1	2.100	2.300	0.083	0.091
P	3.900	4.100	0.154	0.161
ϕ	3.000	3.200	0.118	0.126