

**BIPOLAR TRANSISTOR (NPN)**
**FEATURES**

- Complement To BD138
- High Current

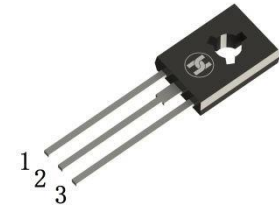

1.EMITTER 2.COLLECTOR 3.BASE

**TO-126**

## Equivalent Circuit

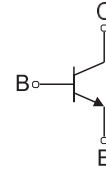
**MECHANICAL DATA**

- Case: TO-126
- Case Material: Molded Plastic. UL flammability
- Classification Rating: 94V-0
- Weight: 0.5 grams (approximate)

**MAXIMUM RATINGS (T<sub>A</sub> = 25°C unless otherwise noted)**

Parameter	Symbol	Value	Unit
Collector-Base Voltage	V <sub>CB0</sub>	60	V
Collector-Emitter Voltage	V <sub>CEO</sub>	60	V
Emitter-Base Voltage	V <sub>EBO</sub>	5	V
Collector Current	I <sub>C</sub>	1.5	A
Collector Power Dissipation	P <sub>C</sub>	1.25	W
Thermal Resistance From Junction To Ambient	R <sub>θJA</sub>	100	°C/W
Junction Temperature	T <sub>J</sub>	150	°C
Storage Temperature	T <sub>STG</sub>	-55 ~+150	°C

**ELECTRICAL CHARACTERISTICS (T<sub>A</sub> = 25°C unless otherwise specified)**

Parameter	Symbol	Min	Typ	Max	Unit	Conditions
Collector-base breakdown voltage	V <sub>(BR)CBO</sub> *	60			V	I <sub>C</sub> =100μA, I <sub>E</sub> =0
Collector-emitter breakdown voltage	V <sub>(BR)CEO</sub> *	60			V	I <sub>C</sub> =30mA, I <sub>B</sub> =0
Emitter-base breakdown voltage	V <sub>(BR)EBO</sub>	5			V	I <sub>E</sub> =100μA, I <sub>C</sub> =0
Collector cut-off current	I <sub>CBO</sub>			0.1	μA	V <sub>CB</sub> =30V, I <sub>E</sub> =0
Emitter cut-off current	I <sub>EBO</sub>			10	μA	V <sub>EB</sub> =5V, I <sub>C</sub> =0
DC current gain	h <sub>FE</sub> *	40		250		V <sub>CE</sub> =2V, I <sub>C</sub> =150mA
		25				V <sub>CE</sub> =2V, I <sub>C</sub> =5mA
		25				V <sub>CE</sub> =2V, I <sub>C</sub> =500mA
Collector-emitter saturation voltage	V <sub>CE(sat)</sub> *			0.5	V	I <sub>C</sub> =500mA, I <sub>B</sub> =50mA
Base-emitter voltage	V <sub>BE</sub>			1	V	V <sub>CE</sub> =2V, I <sub>C</sub> =500mA

\*pulse test: pulse width ≤350μs, duty cycle≤ 2.0%.

**CLASSIFICATION OF h<sub>FE</sub>**

Rank	6	10	16
Range	40-100	63-160	100-250

**BIPOLAR TRANSISTOR (NPN)**

**Typical Characteristics**

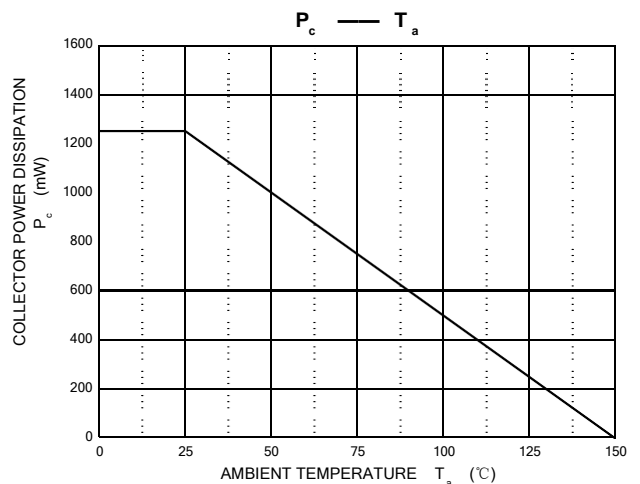
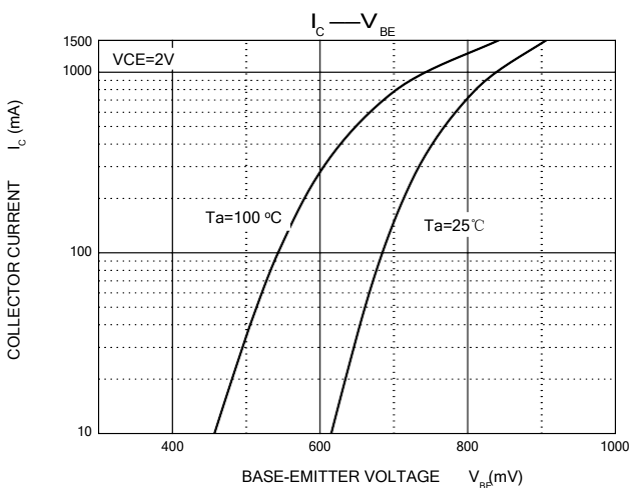
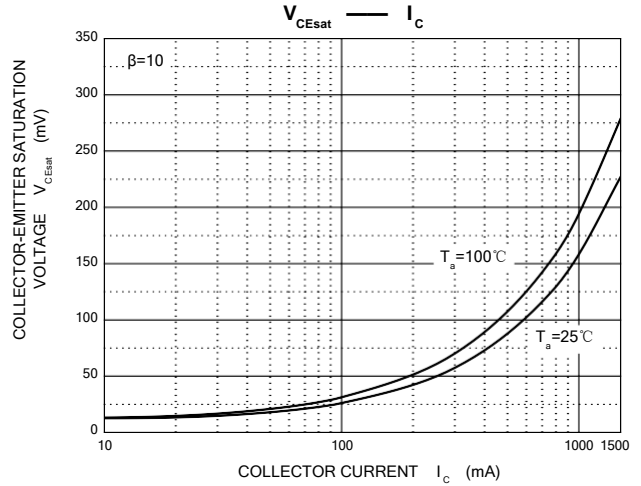
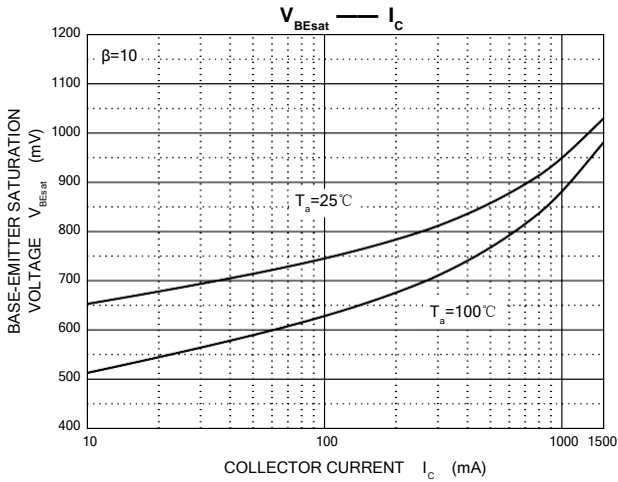
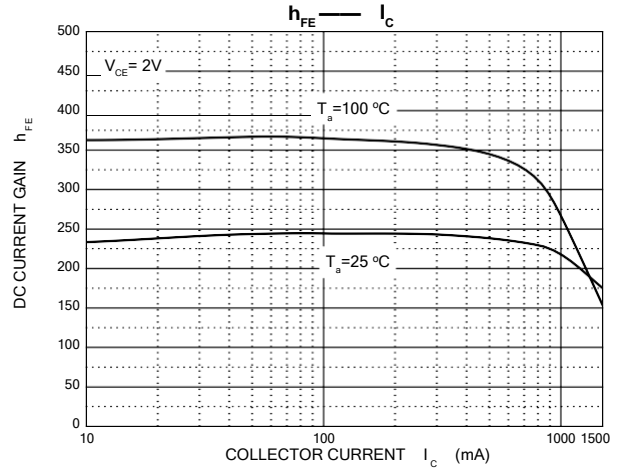
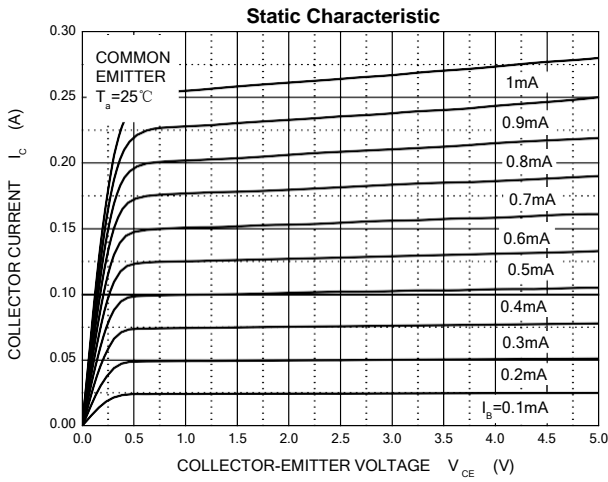

BIPOLAR TRANSISTOR (NPN)

TO-126 Package Outline Dimensions

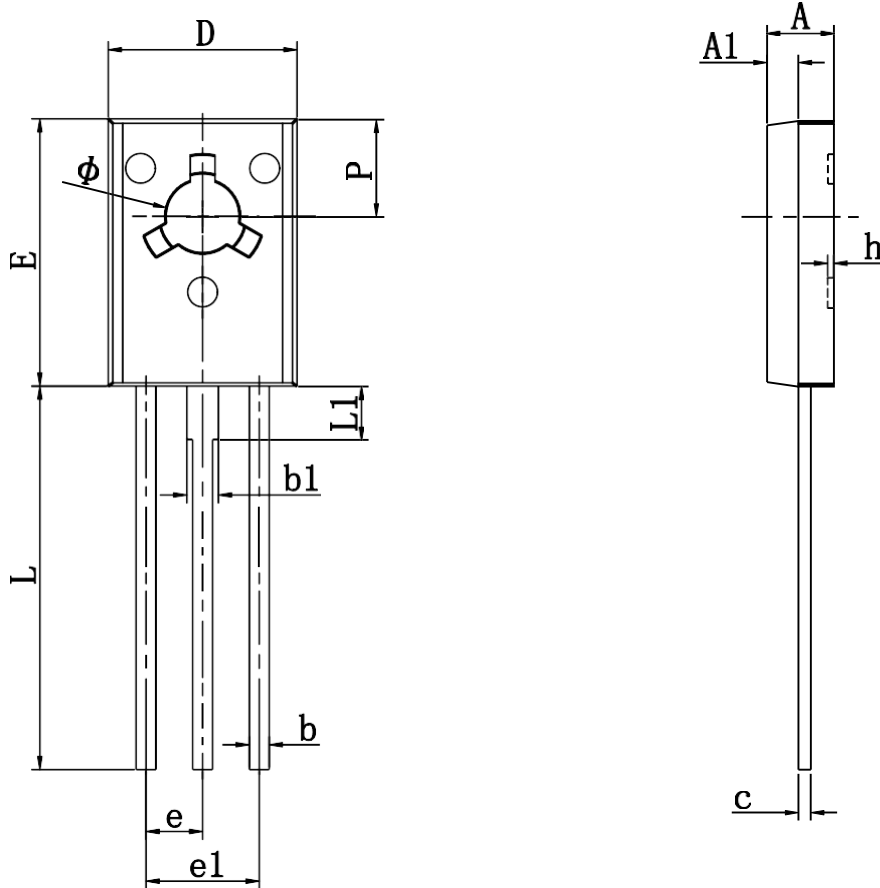

Symbol	Dimensions In Millimeters		Dimensions In Inches	
	Min	Max	Min	Max
A	2.500	2.900	0.098	0.114
A1	1.100	1.500	0.043	0.059
b	0.660	0.860	0.026	0.034
b1	1.170	1.370	0.046	0.054
c	0.450	0.600	0.018	0.024
D	7.400	7.800	0.291	0.307
E	10.600	11.000	0.417	0.433
e	2.290 TYP		0.090 TYP	
e1	4.480	4.680	0.176	0.184
h	0.000	0.300	0.000	0.012
L	15.300	15.700	0.602	0.618
L1	2.100	2.300	0.083	0.091
P	3.900	4.100	0.154	0.161
$\phi$	3.000	3.200	0.118	0.126