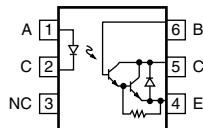
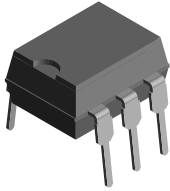


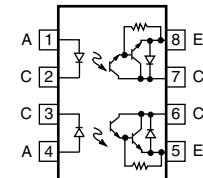
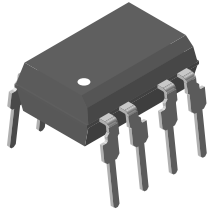


Optocoupler, Photodarlington Output, With Internal RBE (Single, Dual, Quad Channel)

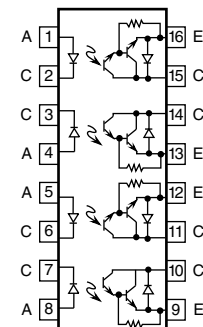
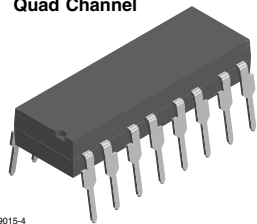
Single Channel



Dual Channel



Quad Channel



FEATURES

- Internal RBE for high stability
- Four available CTR categories per package type
- $BV_{CEO} > 60\text{ V}$
- Standard DIP packages
- Material categorization: for definitions of compliance please see www.vishay.com/doc?99912



RoHS COMPLIANT

DESCRIPTION

IL66, ILD66, and ILQ66 are optically coupled isolators employing gallium arsenide infrared emitters and silicon photodarlington detectors. Switching can be accomplished while maintaining a high degree of isolation between driving and load circuits, with no crosstalk between channels.

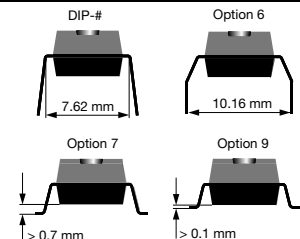
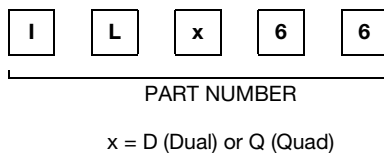
AGENCY APPROVALS

- UL1577, file no. E52744, double protection
- cUL tested to CSA 22.2 bulletin 5A
- DIN EN 60747-5-5 (VDE 0884-5) available with option 1
- BSI EN 60950, BSI EN 60065

1179015-4



ORDERING INFORMATION



AGENCY CERTIFIED/PACKAGE	2 mA			0.7 mA				2 mA						
	CTR (%)													
	SINGLE CHANNEL	DUAL CHANNEL		QUAD CHANNEL										
UL, cUL, BSI	≥ 100	≥ 300	≥ 500	≥ 100	≥ 300	≥ 400	≥ 500							
DIP-6	IL66-1	-	-	-	-	-	-	-	-	-	-	-	-	
DIP-8	-	ILD66-2	ILD66-4	-	-	-	-	-	-	-	-	-	-	
SMD-8, option 7	-	-	ILD66-4X007T	-	-	-	-	-	-	-	-	-	-	
SMD-8, option 9	-	-	ILD66-4X009	-	-	-	-	-	-	-	-	-	-	
DIP-16	-	-	-	ILQ66-1	ILQ66-2	ILQ66-3	ILQ66-4							
SMD-16, option 7	-	-	-	-	-	-	-	-	-	-	-	ILQ66-4X007T		
SMD-16, option 9	-	-	-	-	-	-	-	-	-	-	-	ILQ66-4X009T		
VDE, UL, cUL, BSI	≥ 100	≥ 300	≥ 500	≥ 100	≥ 300	≥ 400	≥ 500							
DIP-6, 400 mil, option 6	IL66-1X016	-	-	-	-	-	-	-	-	-	-	-	-	
DIP-16	-	-	-	-	-	-	-	-	-	-	-	ILQ66-4X001		

Note

- Additional options may be possible, please contact sales office



ABSOLUTE MAXIMUM RATINGS (T _{amb} = 25 °C, unless otherwise specified)					
PARAMETER	TEST CONDITION	PART	SYMBOL	VALUE	UNIT
INPUT					
Peak reverse voltage			V _{RM}	6.0	V
Forward continuous current			I _F	60	mA
Power dissipation			P _{diss}	100	mW
Derate linearly from 25 °C				1.33	mW/°C
OUTPUT					
Power dissipation			P _{diss}	150	mW
Derate from 25 °C				2.0	mW/°C
COUPLER					
Total package power dissipation		IL66	P _{tot}	250	mW
		ILD66	P _{tot}	400	mW
		ILQ66	P _{tot}	500	mW
Derate linearly from 25 °C		IL66		3.3	mW/°C
		ILD66		5.33	mW/°C
		ILQ66		6.67	mW/°C
Storage temperature			T _{stg}	-55 to +125	°C
Operating temperature			T _{amb}	-55 to +100	°C
Lead soldering time at 260 °C				10	s

Note

- Stresses in excess of the absolute maximum ratings can cause permanent damage to the device. Functional operation of the device is not implied at these or any other conditions in excess of those given in the operational sections of this document. Exposure to absolute maximum ratings for extended periods of the time can adversely affect reliability

ELECTRICAL CHARACTERISTICS (T _{amb} = 25 °C, unless otherwise specified)						
PARAMETER	TEST CONDITION	SYMBOL	MIN.	TYP.	MAX.	UNIT
INPUT						
Forward voltage	I _F = 20 mA	V _F	-	1.25	1.5	V
Reverse current	V _R = 6.0 V	I _R	-	0.1	10	μA
Capacitance	V _R = 0 V	C _O	-	25	-	pF
OUTPUT						
Collector emitter breakdown voltage	I _C = 1.0 mA, I _F = 0 A	BV _{CEO}	60	-	-	V
Collector base breakdown voltage (IL66)	I _C = 10 μA	BV _{CBO}	60	-	-	V
Collector emitter leakage current	V _{CE} = 50 V, I _F = 0 A	I _{CEO}	-	1.0	100	nA
Capacitance collector emitter	V _{CE} = 10 V		-	3.4		pF
COUPLER						
Saturation voltage, collector emitter	I _C = 10 mA, I _F = 10 mA	V _{CEsat}	-	0.9	1.0	V

Note

- Minimum and maximum values are testing requirements. Typical values are characteristics of the device and are the result of engineering evaluation. Typical values are for information only and are not part of the testing requirements

CURRENT TRANSFER RATIO (T _{amb} = 25 °C, unless otherwise specified)							
PARAMETER	TEST CONDITION	PART	SYMBOL	MIN.	TYP.	MAX.	UNIT
Current transfer ratio	I _F = 2.0 mA, V _{CE} = 10 V	IL(D,Q)66-1	CTR	100	400	-	%
		IL(D,Q)66-2	CTR	300	500	-	%
	I _F = 0.7 mA, V _{CE} = 10 V	IL(D,Q)66-3	CTR	400	500	-	%
	I _F = 2.0 mA, V _{CE} = 5.0 V	IL(D,Q)66-4	CTR	500	750	-	%



SWITCHING CHARACTERISTICS ($T_{amb} = 25\text{ }^{\circ}\text{C}$, unless otherwise specified)						
PARAMETER	TEST CONDITION	SYMBOL	MIN.	TYP.	MAX.	UNIT
NON SATURATED						
Rise time -1, -2, -4	$V_{CC} = 10\text{ V}$, $I_F = 2.0\text{ mA}$, $R_L = 100\text{ }\Omega$	t_r	-	-	200	μs
Fall time -1, -2, -4	$V_{CC} = 10\text{ V}$, $I_F = 2.0\text{ mA}$, $R_L = 100\text{ }\Omega$	t_f	-	-	200	μs
Rise time -3	$V_{CC} = 10\text{ V}$, $I_F = 0.7\text{ mA}$, $R_L = 100\text{ }\Omega$	t_r	-	-	200	μs
Fall time -3	$V_{CC} = 10\text{ V}$, $I_F = 0.7\text{ mA}$, $R_L = 100\text{ }\Omega$	t_f	-	-	200	μs

SAFETY AND INSULATION RATINGS				
PARAMETER	TEST CONDITION	SYMBOL	VALUE	UNIT
Climatic classification	According to IEC 68 part 1		55 / 100 / 21	
Comparative tracking index		CTI	175	
Maximum rated withstanding isolation voltage	$t = 1\text{ min}$	V_{ISO}	4420	V_{RMS}
Maximum transient isolation voltage		V_{IOTM}	10 000	V_{peak}
Maximum repetitive peak isolation voltage		V_{IORM}	890	V_{peak}
Isolation resistance	$V_{IO} = 500\text{ V}$, $T_{amb} = 25\text{ }^{\circ}\text{C}$	R_{IO}	$\geq 10^{12}$	Ω
	$V_{IO} = 500\text{ V}$, $T_{amb} = 100\text{ }^{\circ}\text{C}$	R_{IO}	$\geq 10^{11}$	Ω
Output safety power		P_{SO}	400	mW
Input safety current		I_{SI}	275	mA
Safety temperature		T_S	175	$^{\circ}\text{C}$
Creepage distance			≥ 7	mm
Clearance distance			≥ 7	mm
Insulation thickness		DTI	≥ 0.4	mm

Note

- As per IEC 60747-5-5, § 7.4.3.8.2, this optocoupler is suitable for "safe electrical insulation" only within the safety ratings. Compliance with the safety ratings shall be ensured by means of protective circuits

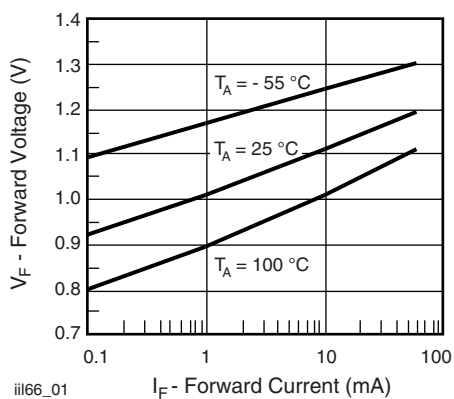
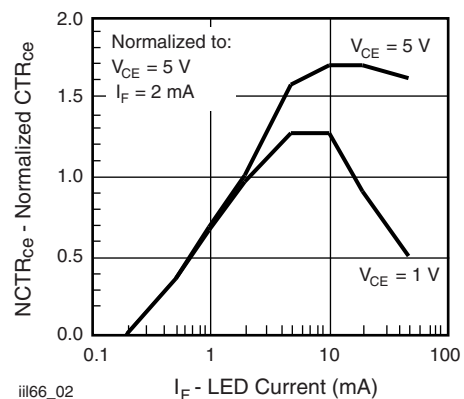
TYPICAL CHARACTERISTICS ($T_{amb} = 25\text{ }^{\circ}\text{C}$, unless otherwise specified)

Fig. 1 - Forward Voltage vs. Forward Current

Fig. 2 - Normalized Non-Saturated and Saturated CTR_{CE} vs. LED Current

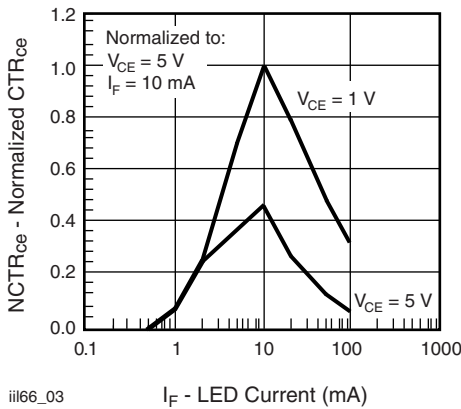


Fig. 3 - Normalized Non-Saturated and Saturated CTR_{CE} vs. LED Current

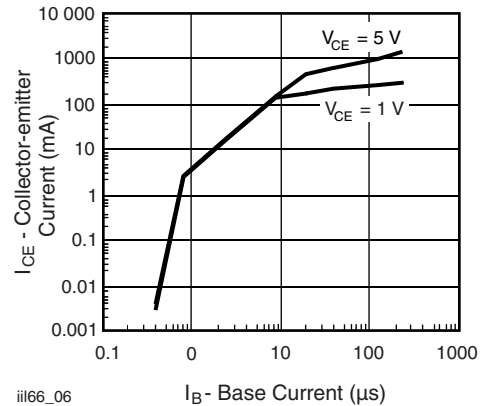


Fig. 6 - Collector Emitter Current vs. LED Current

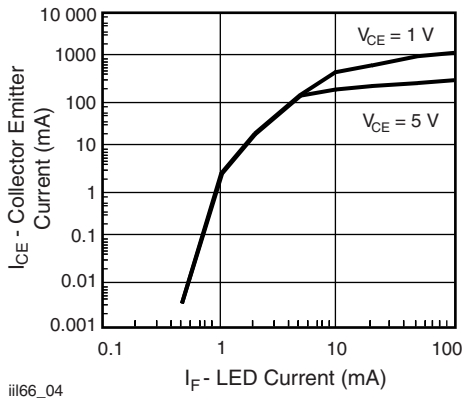


Fig. 4 - Non-Saturated and Saturated Collector Emitter Current vs. LED Current

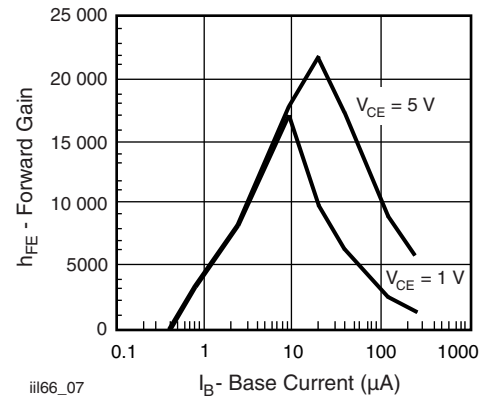


Fig. 7 - Non-Saturated and Saturated h_{FE} vs. LED Current

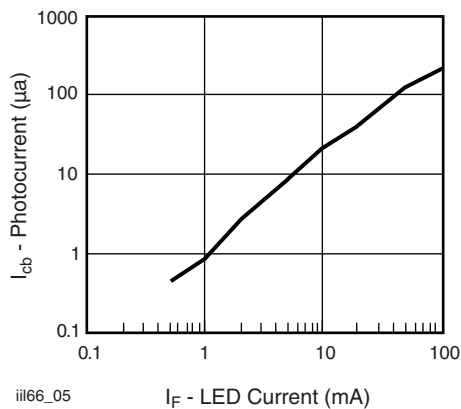


Fig. 5 - Collector Base Photocurrent vs. LED Current

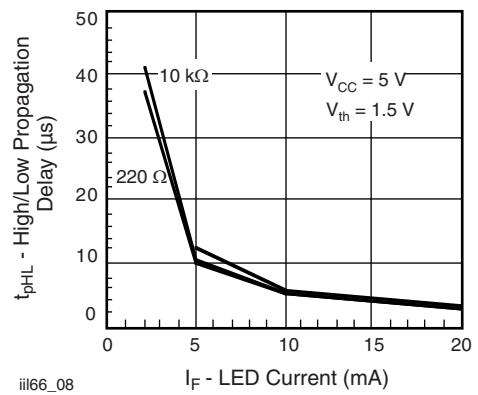


Fig. 8 - High to Low Propagation Delay vs. Collector Load Resistance and LED Current

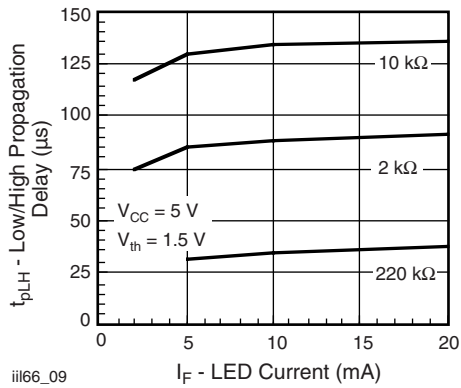


Fig. 9 - Low to High Propagation Delay vs. Collector Load Resistance and LED Current

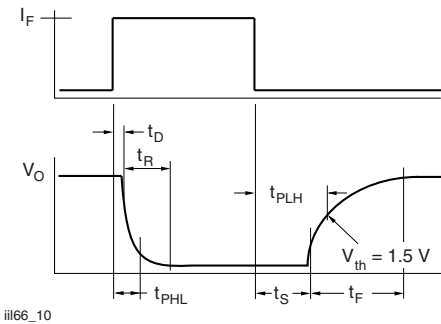


Fig. 10 - Switching Waveform

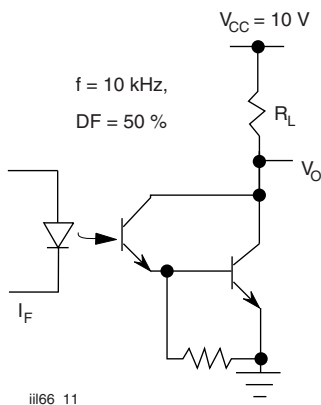
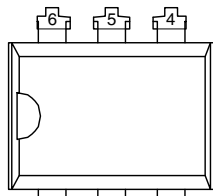
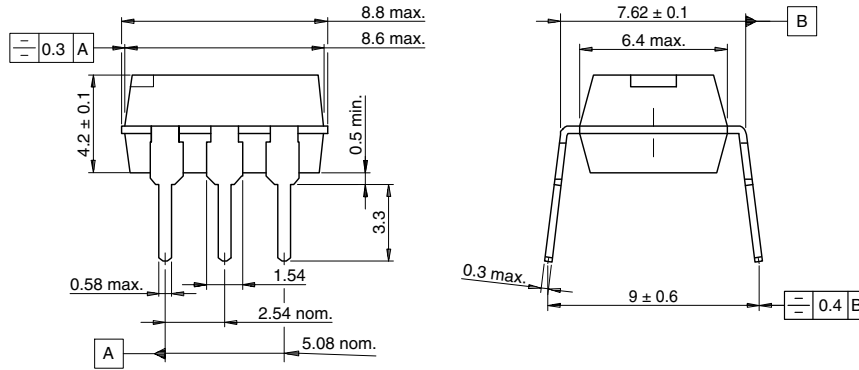


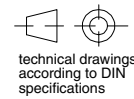
Fig. 11 - Switching Schematic



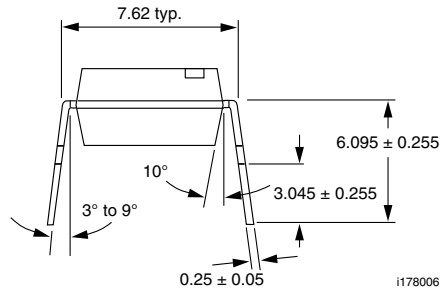
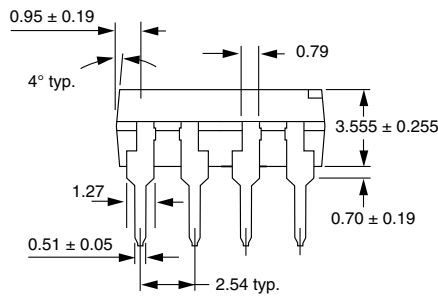
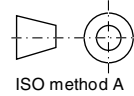
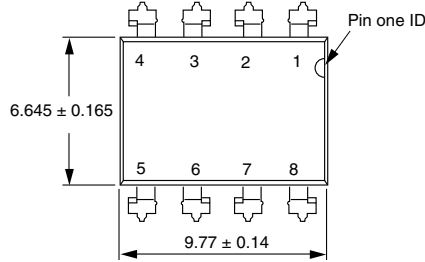
PACKAGE DIMENSIONS in millimeters



Weight: ca. 0.50 g
 Creepage distance: > 6 mm
 Air path: > 6 mm
 after mounting on PC board

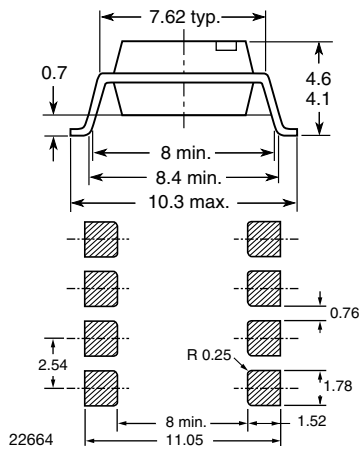


14770-1

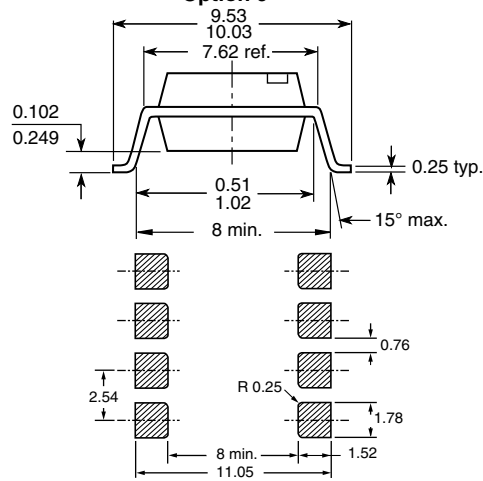


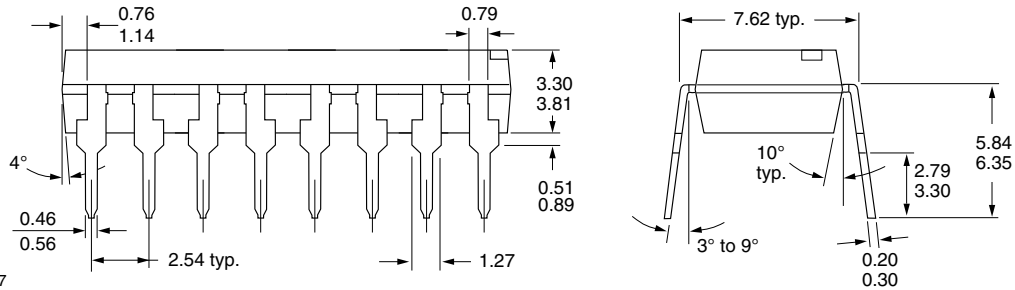
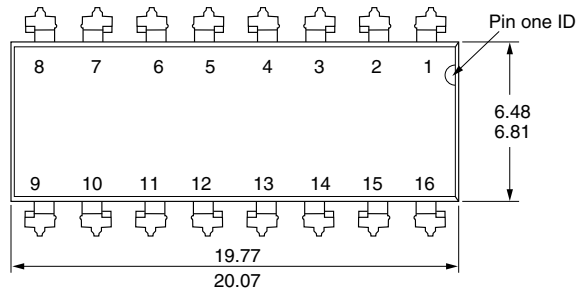
i178006

Option 7



Option 9

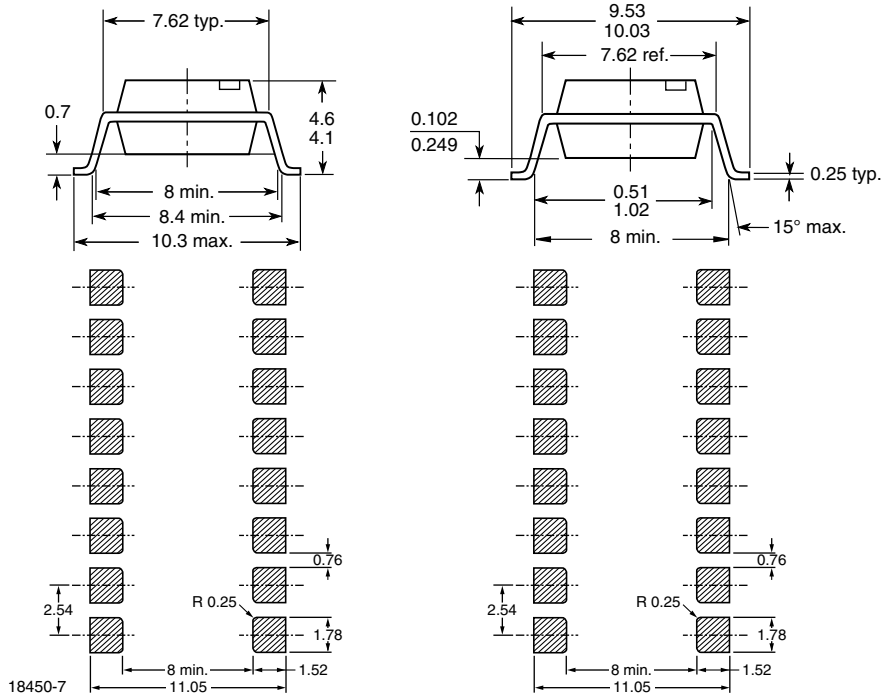




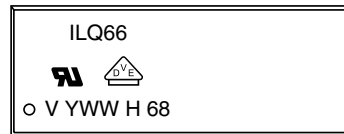
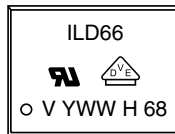
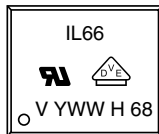
i178007

Option 7

Option 9



PACKAGE MARKING (example)



Notes

- The VDE logo is only marked on option 1 parts, option information is not marked on the part
- Tape and reel suffix (T) is not part of the package marking



Disclaimer

ALL PRODUCT, PRODUCT SPECIFICATIONS AND DATA ARE SUBJECT TO CHANGE WITHOUT NOTICE TO IMPROVE RELIABILITY, FUNCTION OR DESIGN OR OTHERWISE.

Vishay Intertechnology, Inc., its affiliates, agents, and employees, and all persons acting on its or their behalf (collectively, "Vishay"), disclaim any and all liability for any errors, inaccuracies or incompleteness contained in any datasheet or in any other disclosure relating to any product.

Vishay makes no warranty, representation or guarantee regarding the suitability of the products for any particular purpose or the continuing production of any product. To the maximum extent permitted by applicable law, Vishay disclaims (i) any and all liability arising out of the application or use of any product, (ii) any and all liability, including without limitation special, consequential or incidental damages, and (iii) any and all implied warranties, including warranties of fitness for particular purpose, non-infringement and merchantability.

Statements regarding the suitability of products for certain types of applications are based on Vishay's knowledge of typical requirements that are often placed on Vishay products in generic applications. Such statements are not binding statements about the suitability of products for a particular application. It is the customer's responsibility to validate that a particular product with the properties described in the product specification is suitable for use in a particular application. Parameters provided in datasheets and / or specifications may vary in different applications and performance may vary over time. All operating parameters, including typical parameters, must be validated for each customer application by the customer's technical experts. Product specifications do not expand or otherwise modify Vishay's terms and conditions of purchase, including but not limited to the warranty expressed therein.

Except as expressly indicated in writing, Vishay products are not designed for use in medical, life-saving, or life-sustaining applications or for any other application in which the failure of the Vishay product could result in personal injury or death. Customers using or selling Vishay products not expressly indicated for use in such applications do so at their own risk. Please contact authorized Vishay personnel to obtain written terms and conditions regarding products designed for such applications.

No license, express or implied, by estoppel or otherwise, to any intellectual property rights is granted by this document or by any conduct of Vishay. Product names and markings noted herein may be trademarks of their respective owners.