



January 2010

FEATURES

- * Isolation voltage between input and output $V_{iso} : 5,000V_{rms}$
- * 6pin DIP zero-cross optoisolators triac driver output
- * High repetitive peak off-state voltage $V_{DRM} : \text{Min. } 600V$
- * High critical rate of rise of off-state voltage
($dv/dt : \text{MIN. } 1000V / \mu s$)
- * Dual-in-line package :
MOC3063
- * Wide lead spacing package :
MOC3063M
- * Surface mounting package :
MOC3063S
- * Tape and reel packaging :
MOC3063S-TA1
- * Safety approval
UL / CSA / FIMKO / VDE* approved
*Required "V" ordering option
- * RoHS compliance

APPLICATIONS

- * AC Motor Drives
- * AC Motor Starters
- * E.M. Contactors
- * Lighting Controls
- * Solenoid/Valve Controls
- * Solid State Relays
- * Static Power Switches
- * Temperature Controls

OUTLINE DIMENSIONS

Dual-in-line package :

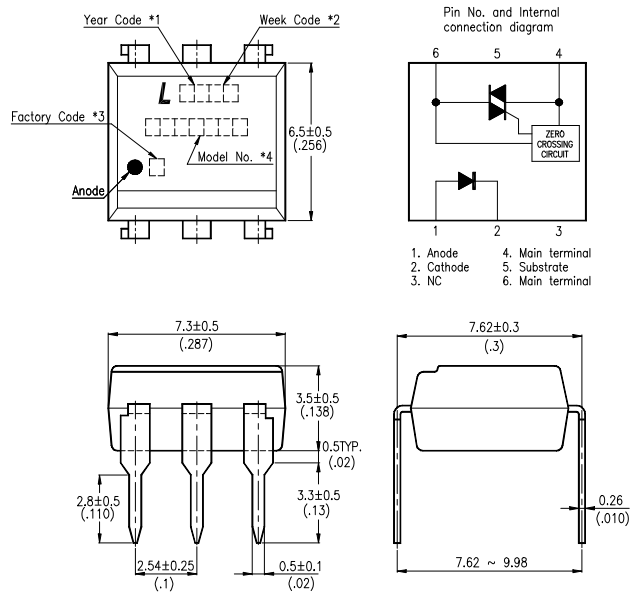

Wide lead spacing package:

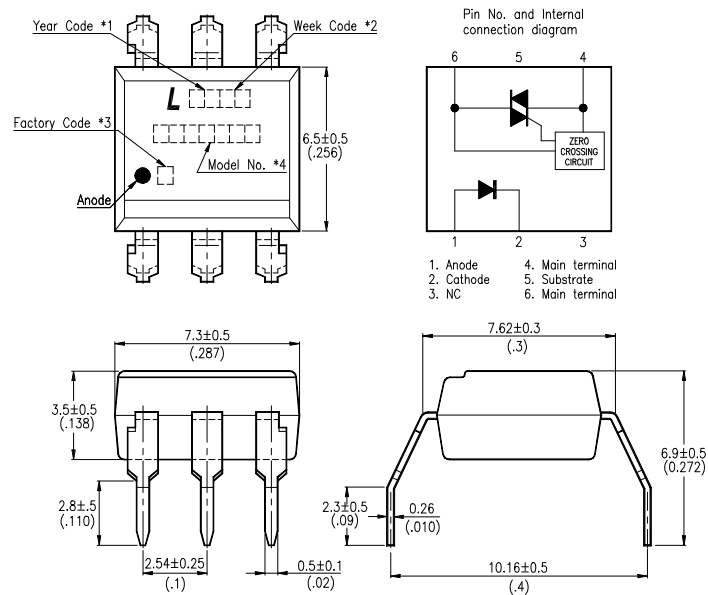

- *1. Year date code.
- *2. 2-digit work week.
- *3. Factory identification mark shall be marked.
(Z : Taiwan, Y : Thailand, X : China-TJ, W : China-CZ)
- *4. Model No.: MOC3063

OUTLINE DIMENSIONS

Surface mounting package :

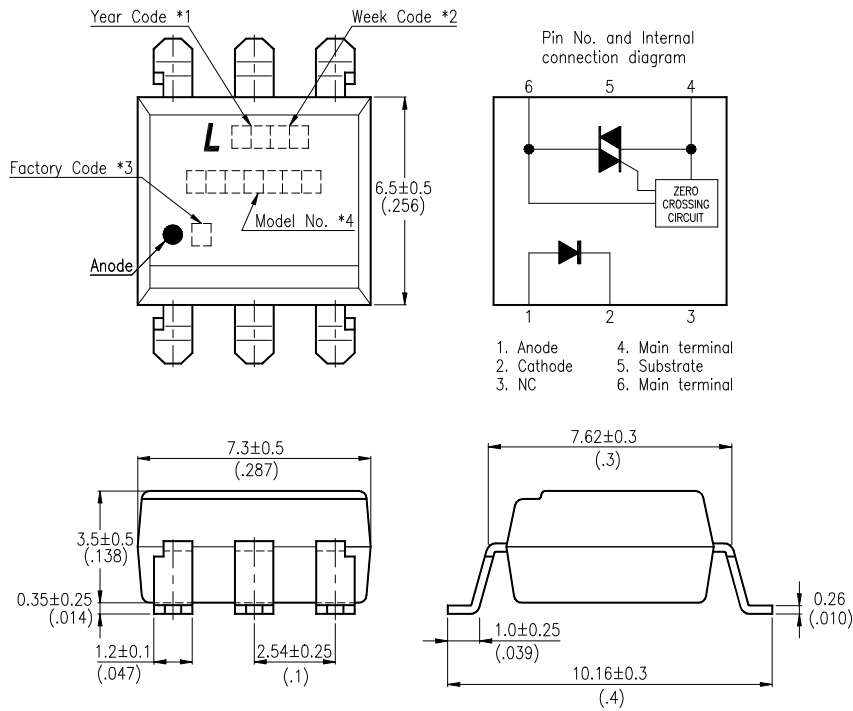

- *1. Year date code.
- *2. 2-digit work week.
- *3. Factory identification mark shall be marked.
(Z : Taiwan, Y : Thailand, X : China-TJ, W : China-CZ)
- *4. Model No.: MOC3063

TAPING DIMENSIONS

Tape and reel package :

MOC3063S-TA1

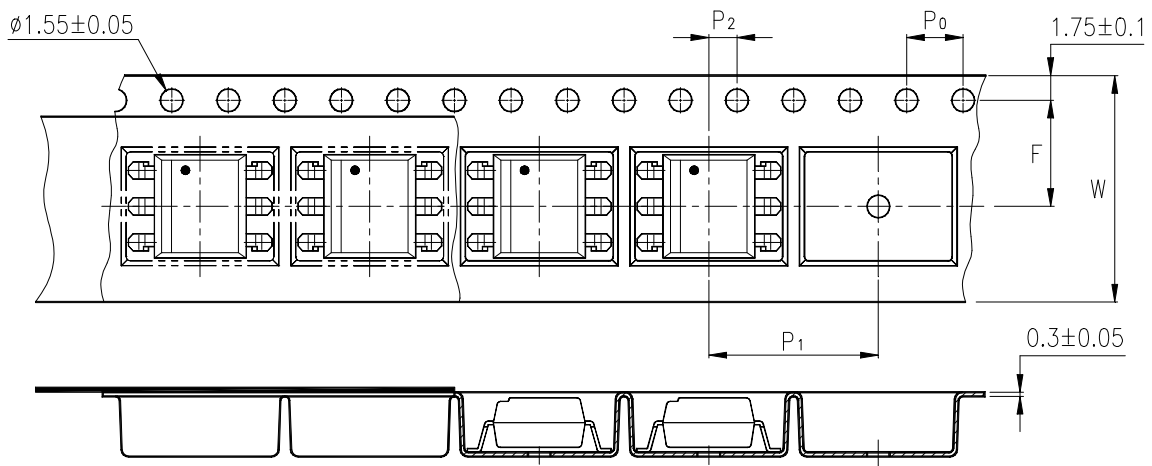

Description	Symbol	Dimensions in mm (inches)
Tape wide	W	16 ± 0.3 (.63)
Pitch of sprocket holes	P_0	4 ± 0.1 (.15)
Distance of compartment	F	7.5 ± 0.1 (.295)
Distance of compartment to compartment	P_2	2 ± 0.1 (.079)
Distance of compartment to compartment	P_1	12 ± 0.1 (.472)

ABSOLUTE MAXIMUM RATING

(Ta = 25°C)

PARAMETER		SYMBOL	RATING	UNIT
INPUT	Forward Current	I _F	50	mA
	Reverse Voltage	V _R	6	V
	Power Dissipation	P _D	120	mW
OUTPUT	Off-State Output Terminal Voltage	V _{DRM}	600	V
	Peak Repetitive Surge Current (PW=100μs, 120pps)	I _{TSM}	1	A
	Collector Power Dissipation	P _C	150	mW
Total Power Dissipation		P _{tot}	250	mW
*1	Isolation Voltage	V _{iso}	5,000	V _{rms}
Ambient Operating Temperature Range		T _A	-40 ~ +100	°C
Storage Temperature Range		T _{stg}	-55 ~ +150	°C
*2	Soldering Temperature	T _L	260	°C

*1. AC For 1 Minute, R.H. = 40 ~ 60%

Isolation voltage shall be measured using the following method.

- (1) Short between anode and cathode on the primary side and between collector, emitter on the secondary side.
- (2) The isolation voltage tester with zero-cross circuit shall be used.
- (3) The waveform of applied voltage shall be a sine wave.

*2. For 10 Seconds

ELECTRICAL - OPTICAL CHARACTERISTICS

(Ta = 25°C)

PARAMETER		SYMBOL	MIN.	TYP.	MAX.	UNIT	CONDITIONS
INPUT	Forward Voltage	V_F	—	1.2	1.4	V	$I_F=20mA$
	Reverse Current	I_R	—	0.05	10	μA	$V_R=6V$
OUTPUT	*1 Peak Blocking Current, Either Direction	I_{DRM1}	—	—	500	nA	$V_{DRM} = 600V$
	Peak On-State Voltage, Either Direction	V_{TM}	—	—	3.0	V	$I_{TM}=100 mA$ Peak
	*2 Critical rate of Rise of Off-State Voltage	dv/dt	1000	—	—	V/ μs	
COUPLED	*3 Led Trigger Current, Current Required to Latch Output, Either Direction	MOC3063 I_{FT}	—	—	5	mA	Main Terminal Voltage = 3V
	Holding Current, Either Direction	I_H	—	400	—	μA	
ZERO CROSSING	Inhibit Voltage	V_{INH}	—	5	20	Volts	$I_F=Rated I_{FT}$, MT1-MT2 Voltage above which device will not trigger.
	Leakage in Inhibited State	I_{DRM2}	—	—	500	μA	$I_F = Rated I_{FT}$, Rated V_{DRM} , Off State

*1 Test voltage must be applied within dv/dt rating.

*2 This is static dv/dt. Commutating dv/dt is a function of the load-driving thyristor(s) only.

*3 All devices are guaranteed to trigger at an I_F value less than or equal to max I_{FT} . Therefore, recommended operating I_F lies between max I_{FT} 5mA for MOC3063 and absolute max I_F (50mA)

CHARACTERISTICS CURVES

Fig.1 Forward Current vs. Ambient Temperature

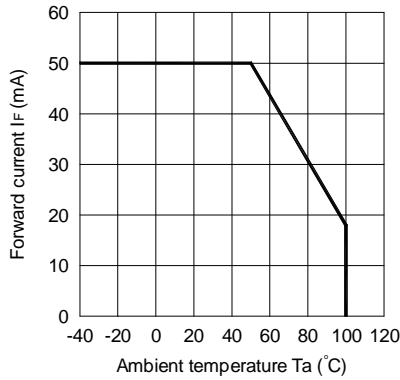

Fig.2 On-state Current vs. Ambient Temperature

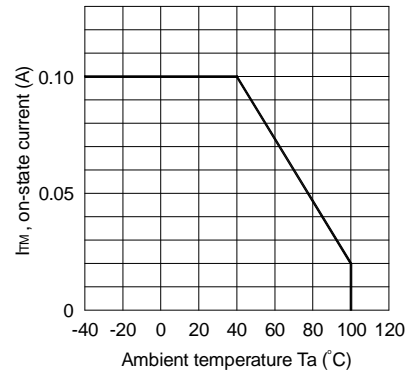

Fig.3 Minimum Trigger Current vs. Ambient Temperature

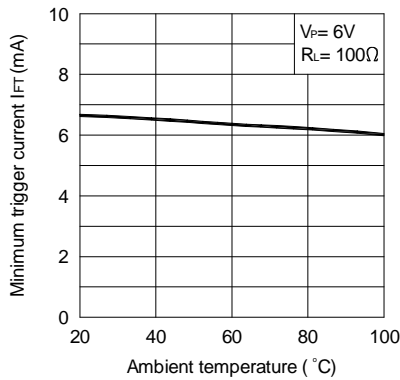

Fig.4 Forward Current vs. Forward Voltage

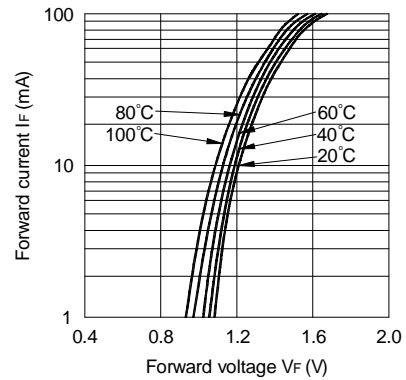

Fig.5 On-state Voltage vs. Ambient Temperature

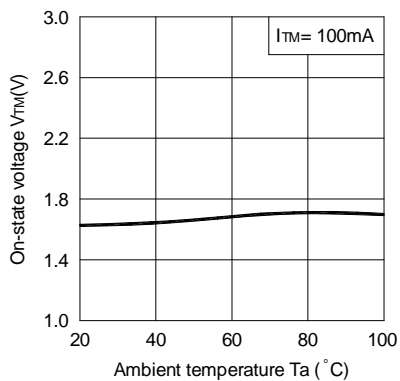
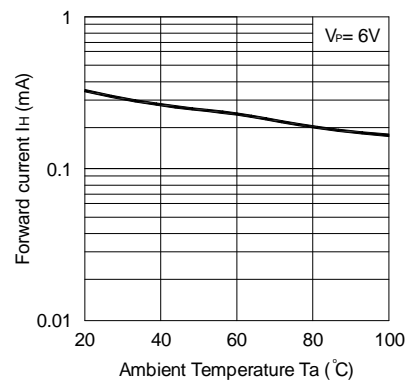

Fig.6 Holding Current vs. Ambient Temperature



CHARACTERISTICS CURVES

Fig. 7 Repetitive Peak Off-state Current vs. Temperature

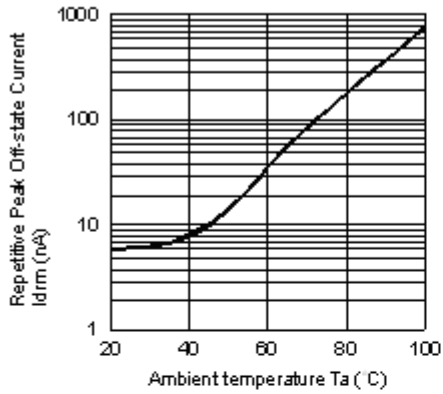
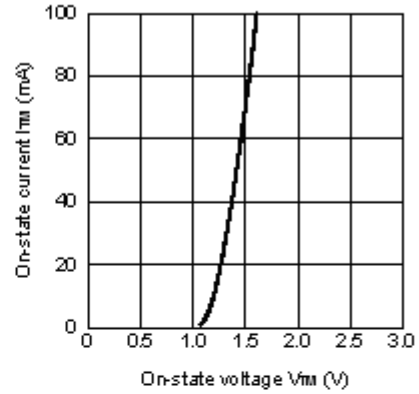
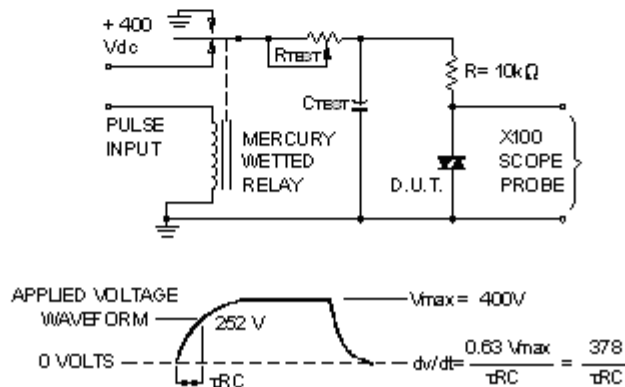

Fig. 8 On-state Current vs. On-state Voltage



Static dv/dt Test Circuit



RECOMMENDED FOOT PRINT PATTERNS (MOUNT PAD)

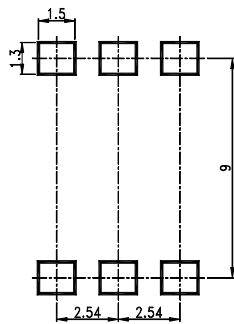

Unit : mm